

2024

Version 1



**INSULATING CONCRETE FORMS**  
MANUFACTURERS ASSOCIATION  
[ICF-MA.ORG](http://ICF-MA.ORG)



ICF BUILDING SYSTEM

[INTEGRASPEC.COM](http://INTEGRASPEC.COM)

**The Insulating Concrete Forms Manufacturers Association  
Prescriptive ICF Design for Part 9 Structures in Canada**

**LEARN MORE ABOUT ICFS AT [ICF-MA.ORG](http://ICF-MA.ORG)**

This engineering is only authorized for use by ICFMA Members. ©2024 All Rights Reserved.



# ICFMA

**INSULATING CONCRETE FORMS**  
MANUFACTURERS ASSOCIATION

**The ICFMA Prescriptive ICF Design  
for Part 9 Structures in Canada**  
Second Edition

**INSULATING CONCRETE FORMS**  
MANUFACTURERS ASSOCIATION

# ICFMA

**INSULATING CONCRETE FORMS**  
MANUFACTURERS ASSOCIATION

# The Insulating Concrete Forms Manufacturers Association Prescriptive ICF Design for Part 9 Structures in Canada Second Edition

## Introduction

### Preface

Welcome to the Second Edition of the ICFMA Prescriptive ICF Design Tables for Part 9 Buildings in Canada. The following guideline specifications were developed on behalf of the member companies of the Insulating Concrete Form Manufacturers Association (ICFMA) by Tacoma Engineers Inc. with offices in Ontario, Canada.

### Objective

The objective of this manual is to provide Prescriptive Tables, Engineering Details and ICF product information that is code compliant for buildings constructed under Part 9 of the 2020 National Building Code of Canada. This manual provides code compliant information for Insulating Concrete Forms across each provincial region of Canada and contains a broad scope of residential designs that cover specific nuances of individual provincial regions. Each of the tables and designs cover the standard specifications for products manufactured or produced by members of the ICFMA. This guide is available in both English and French language versions.

### Scope

Design information contained in this guide applies to below-grade and above-grade ICF reinforced concrete walls, both load bearing and non-load bearing, that make up the exterior and/or interior of Part 9 buildings that fall within the limitations of this guide. Floor design/connections and roof design/connections are not covered in this guide and must be designed by others. Any other building component not specifically named in this guide must be designed by others or follow prescriptive provisions contained in the applicable building code. Fire resistance characteristics of ICF/concrete walls are not covered in this guide, but are available from your ICFMA member company upon request.

### Applicability

The tables in this manual are the property of the ICFMA and are specific to products offered by ICFMA member companies. The tables are not authorized for use by non-member ICF manufacturers or non-ICF methods of concrete forming. If specific questions arise about how to design or reference the tables in this manual of an ICFMA members product check with the technical department of that ICFMA member company. For example: Coursing height may vary between 12 inches and 18 inches depending on brand used. Horizontal tie spacing may vary between 6 inches and 12 inches. Product specific nuances may affect how the tables in the guide are used.

Design information contained in this document is limited to use in buildings described in Section 1 "Design Parameters" of the guide, including a maximum number of below-grade and above-grade stories as well as certain building size limitations. While the intent of this guide are the broadest applicability of Canada and it's individual provinces, there are some limits to applicability, including seismic response and wind loading. Building design may be limited by spans, deflection and aspect ratio among others.

**CHECK ALL CONDITIONS THAT APPLY TO YOUR SITE AND BUILDING DESIGN TO ENSURE COMPATIBILITY WITH THE LIMITATIONS STATED IN SECTION 1 OF THIS GUIDE BEFORE PROCEEDING WITH ITS USE.**

## Engineered Design

These tables and specifications have been developed and reviewed against the 2020 National Building Code of Canada and CSA A23.3 by Tacoma Engineers. [www.tacomaengineers.com](http://www.tacomaengineers.com) Tables carry a stamp for all Canadian provinces. Check for a stamp applicable to your province before using or referring to the tables.

Review for code compliance will be carried out as building code and standards versions evolve. Check with your ICF member company for the most current guide version available.

### Errata

All efforts have been made to create a publication free from errors. If ICFMA is notified of or discovers errors, errata will be published and posted on the ICFMA website at [www.icfma.org](http://www.icfma.org).

### Copyright

©2024 Insulating Concrete Form Manufacturers Association  
All rights reserved. No part of this publication may be reproduced, stored in a retrieval system, or transmitted in any form or by any means, electronic, mechanical, photocopying, recording, or otherwise, without the prior permission of the copyright owner.

The Insulating Concrete Form Manufacturers Association (ICFMA) is a not-for-profit trade organization and provides this publication solely for the continuing education of qualified building design and construction professionals. This publication should only be used by qualified professionals who possess all required license(s) in the authority having jurisdiction and who are competent to evaluate the significance and limitations of the information provided herein. Any qualified professional who chooses to use any of the information found in this publication must accept total responsibility for the application of this information. Other readers should obtain assistance from a Qualified Professional before proceeding.

ICFMA and its members make no express or implied warranty with respect to this publication or any information contained herein. No warranty is made of merchantability or fitness for a particular purpose. ICFMA and its members disclaim any product liability (including without limitation any strict liability in tort) in connection with this publication or any information contained herein.

### Acknowledgments

The Insulating Concrete Form Manufacturers Association wishes to express its thanks to the following individuals for their contributions and guidance throughout the process of creating this guide:

Ross Monsour – ICFMA Director  
Robert Schulthorpe – Engineering Consultant  
Nathan Proper – Tacoma Engineers  
Morteza Mehrzadi – Tacoma Engineers  
Jason Unruh – SuperForm ICF  
Dennis Micoff – BuildBlock ICF  
Francis Roma – Logix ICF  
Keven Rector – Nudura ICF  
Douglas Bennion – Quad-Lock ICF  
Kelvin Doerr – Fox Blocks ICF  
Brian Corder – BuildBlock ICF  
Pooja Patel – Amvic ICF

# ICFMA

**INSULATING CONCRETE FORMS**  
MANUFACTURERS ASSOCIATION

# CONTENTS

Design Limitation.....	6
1. Design Parameters.....	6
2. Construction .....	7
3. Concrete .....	8
4. Reinforcing Steel .....	8
5. Above Grade and Below Grade Walls.....	9
5.1. Distributed Reinforcing Steel.....	10
5.2. Shear Walls.....	11
5.3. Concentrated Point Loads on Walls.....	12
5.4. Window and Door Openings .....	12
5.4.1. Lintels.....	12
5.5. Stair Openings.....	13
5.6. Laterally Supported Unreinforced Foundation Wall .....	14
5.7. Laterally Unsupported Foundation Walls (Knee Wall) with Wood Framing Above.....	14
6. Wood Ledger Connection.....	14
7. Brick Ledge.....	15
8. Strip Footing.....	15
List of Details.....	17
List of Tables.....	18
Below & Above Grade Walls Details and Tables.....	22
Lintel Details and Tables.....	95
Concentrated Point Load Table .....	122
Stair Opening Tables .....	123
Laterally Supported Foundation Wall Detail and Table .....	126
Laterally Unsupported Foundation Wall Detail and Table .....	127
Ledger Connection Detail and Table .....	129
Brick Ledge Detail and Table.....	130
Footings Details and Tables .....	132
Appendix A. Equivalent Spectral Response Acceleration for ICF Walls, $S_{a,ICF}$ .....	136
Appendix B. Climatic Design Data .....	139

## Design Limitation

The design tables included in this manual were determined based on the parameters provided in this section. These tables cannot be used if the proposed construction does not meet all the parameters provided in this section or in the tables.

### 1. Design Parameters

- 1.1. These tables only apply to residential buildings conforming to Part 9 of the 2020 National Building Code of Canada (NBCC).
- 1.2. If the proposed construction does not meet the design or applicability of parameters noted herein, a local design professional shall be retained to prepare the design in accordance with applicable standards.
- 1.3. This design manual applies only to flat ICF walls (concrete core of uniform thickness). All walls must line up vertically.
- 1.4. In case this document conflicts with design codes, standards and building regulations, the code provisions shall apply.
- 1.5. The design and construction of all work shall conform to the latest editions of the NBCC, the local building code, local regulations and bylaws and the occupational health and safety act.
- 1.6. These tables have been designed to resist gravity, wind and earthquake forces in accordance with the 2020 NBCC for the criteria indicated in the design limitations and in the design tables.
- 1.7. Design is limited to one (1) floor below grade and a maximum of two (2) stories above grade.
- 1.8. The maximum building dimensions are:

Building Area	300 m <sup>2</sup>	3200 ft <sup>2</sup>
Maximum Building Dimension	24.4 m	80 ft
Building Aspect Ratio (Length:Width)		
$S_{a,ICF} \leq 0.16$	2.5:1	
$S_{a,ICF} > 0.16$	2:1	
Roof Clear Span	12.2 m	40 ft
Floor Clear Span	7.32 m	24 ft
Second Floor Wall Height	3.05 m	10 ft
Main Floor Wall Height	4.88 m	16 ft
Foundation Wall Height	3.66 m	12 ft

Note:  $S_{a,ICF}$  is the equivalent spectral response acceleration for ICF walls, provided in Appendix A.



1.9. The maximum unfactored gravity loads are:

Roof Snow	4.0 kPa	84 psf
Floor Live	1.9 kPa	40 psf
Roof Dead	0.7 kPa	15 psf
Floor Dead	0.7 kPa	15 psf
Concrete Density	23.6 kN/m <sup>3</sup>	150 lb/ft <sup>3</sup>
Brick Veneer Density	20.0 kN/m <sup>3</sup>	128 lb/ft <sup>3</sup>

1.10. The lateral soil pressures against below grade walls are:

Area Surcharge (K <sub>o</sub> = 0.5)	2.4 kPa	50 psf
Equivalent Fluid Density of Soil (K <sub>o</sub> =1.0)	480 – 1200 kg/m <sup>3</sup>	30 – 75 pcf

1.11. The wind loads are indicated in the design tables.

1.12. Seismic limits in wall analysis and design are based on S<sub>a</sub> (0.2) and S<sub>a</sub> (0.5) values. In order to simplify the tables, an equivalent seismic spectral response acceleration for ICF walls, S<sub>a,ICF</sub> is defined and provided in Appendix A. Equivalent spectral response, S<sub>a,ICF</sub>, is the ratio of seismic base shear to the building weight for a site class “D” as given in following equation and the limits are indicated in shear wall tables.

$$S_{a,ICF} = V_{seismic} / W$$

A professional engineer must design the ICF walls for locations where the S<sub>a,ICF</sub> is not provided in Appendix A.

1.13. The following peak ground acceleration (PGA) data was used in the analysis of below grade walls. These are the maximum associated values from Climatic Data of the 2020 NBCC for the selected S<sub>a,ICF</sub> values.

S <sub>a,ICF</sub>	0.11	0.16	0.31	0.79
PGA	0.15	0.24	0.49	1.21

1.14. Only seismic site classes A, B, C and D, as defined in Part 4 of the NBCC, are permitted.

1.15. Wall and lintel deflections have been limited to L/360.

1.16. The maximum building aspect ratio is the longest plan dimension divided by the shortest plan dimension of the building. Attached garages can be excluded from the aspect ratio calculation provided they are separated from the main building by ICF walls meeting the requirements of this guide.

## 2. Construction

2.1. Except as noted otherwise for specific conditions, the design assumes that ALL walls are laterally supported by the building foundation, roof and floor systems, designed by others. Roof and floor systems can be designed in accordance with part 9 of NBCC or building system manufacturers.

2.2. Foundation walls shall be laterally supported at the top and bottom prior to backfilling.

- 2.3. Provide lateral support at the bottom of the foundation wall in accordance with NBCC 2020 part 9.15.4.4. Alternatively, dowel the wall to the footing as per Table F. 1.
- 2.4. The contractor shall make adequate provision for construction loads and temporary bracing to keep the structure plumb and in true alignment at all phases of construction.
- 2.5. Hydrostatic pressure due to water build-up has not been included in the design and analysis. Backfill shall be drained in accordance with NBCC 2020 9.4.4.6.
- 2.6. Surface grading around the foundation is to slope away from building to allow surface water to drain away.
- 2.7. Provide adequate frost protection for all foundation walls and footings, both during construction and in the final installation.
- 2.8. Construction joints shall be made and located so as not to impair the strength of the structure. All specified reinforcing bars shall have minimum lap lengths across all construction joints.
- 2.9. Construction joints shall not be installed within 610 mm (2ft) of a wall opening.
- 2.10. All dimensions are in millimeters unless noted otherwise.
- 2.11. It is the responsibility of the roof and floor designer to ensure adequate bearing for all framing members is provided on the concrete walls.

### **3. Concrete**

- 3.1. Concrete work shall conform to the latest editions of CSA A23.1,2,3 for materials and workmanship.
- 3.2. The minimum 28-day compressive strength of concrete shall be 25 MPa, for 6" thick walls and 20 MPa for other walls.
- 3.3. Maximum size of aggregates in concrete walls with minimum concrete cover of 40mm, are to be 19mm (3/4") diameter. Maximum aggregate size shall be limited to 12.5mm (1/2") if the concrete cover is less than 40mm.
- 3.4. Concrete pours shall be terminated at locations of lateral support.
- 3.5. Use high frequency vibration to place all concrete. Extra care is needed when vibrating during concrete placement for the purpose of ensuring a homogenous aggregate distribution, without segregation.
- 3.6. Take adequate measures to protect concrete from exposure to freezing temperatures and precipitation at least seven days after concrete placement.

### **4. Reinforcing Steel**

- 4.1. Use Grade 400 deformed rebar placed in accordance with the manual of standard practice.
- 4.2. Reinforcement size, spacing and placement to be in accordance with notes and design tables for above grade walls, below grade walls and lintels.
- 4.3. 10M bars may be installed as distributed steel where 15M bars are specified provided they are installed at half the spacing required for 15M bars. 15M bars may be installed as distributed steel where 10M bars are specified, but must be installed at the same spacing as specified for the 10M bars.
- 4.4. Maintain a minimum concrete clear cover and reinforcement spacing of 40mm (1 1/2") for all reinforcing steel, except 20mm (3/4") cover is permitted for below grade walls of heated buildings. The minimum concrete covers must be maintained for vertical bars in below grade walls.

4.5. Where bars within a lintel cannot achieve a minimum concrete side cover and spacing of 40mm (1½"), the bars are required to be bundled. The following notes apply to all bundled bars:

- a) Groups of parallel reinforcing bars bundled in contact, assumed to act as a unit, with not more than four in any one bundle, may be used. Bundled bars shall be tied, wired, or otherwise fastened together to ensure that they remain in position.
- b) Bundled bars shall not be spliced over the span of any lintel.

4.6. Minimum bar lap length shall be:

- a) 450 mm (18") for 10M bars
- b) 650 mm (26") for 15M bars
- c) 750 mm (30") for 20M bars

4.7. Standard hook lengths shall be:

- a) 200 mm (8") for 10M bars
- b) 250 mm (10") for 15M bars
- c) 300 mm (12") for 20M bars

4.8. Maximum transverse spacing (gap) between non-contact parallel bars spliced by lap splices, shall not exceed the lesser of one-fifth of the required lap splices length or 150mm.

4.9. Guidance was taken from PCA 100-2017 Prescriptive Design of Exterior Walls for One- and Two-Family Dwellings where steel reinforcement does not meet the minimum requirements of CSA A23.3 Clause 14.1. References to research conducted by PCA for these conditions are included in PCA 100-2017.

4.10. Where the vertical wall reinforcement spacing exceeds maximum spacing requirements according to CSA A23.3 Clause 14.1 the design capacity is at least one third more than required.

4.11. Horizontal temperature and shrinkage reinforcing steel may be less than specified in CSA A23.3. This is due to ideal curing conditions within the ICF system, which reduce the risk of cracking. In addition, finishes are not applied directly to the concrete wall; therefore, the risk of potential cracks propagating to the surface of the finishes is minimized.

## 5. Above Grade and Below Grade Walls

5.1. Wall thicknesses given in above and below grade wall tables are the nominal thicknesses. The actual thickness of the wall may vary by ± ¼".

5.2. Above grade and below grade walls are designed to resist out-of-plane and in-plane loads by providing the specified reinforcing steel.

5.3. Provide horizontal and vertical distributed steel throughout all walls as described in the Distributed Reinforcing Steel section.

5.4. Provide additional concentrated horizontal and vertical steel around door and window openings, beside stair openings, under point loads, and at the ends of all walls and at all corners as described in the Window and Door Openings, Stair Openings, Concentrated Point Loads and Shear Walls sections.

- 5.5. The specified reinforcing is applicable to building with walkout basements. However, the global slope stability and building stability for unbalance soil pressures created by the walkout condition is by others.
- 5.6. Provide 600 mm (24") × 600 mm (24") horizontal bent dowel at each corner of the walls. Size and spacing of the dowel should match the horizontal reinforcement as per above and below grade tables.

## 5.1. Distributed Reinforcing Steel

- 5.1.1. Horizontal reinforcing is to consist of 10M or 15M continuous bars at 300 mm (12") o.c. to 900mm (36") o.c., in accordance with the tables.
- 5.1.2. Provide one continuous horizontal bar at maximum 150mm (6") from the top of the wall and at all floor levels.
- 5.1.3. Tables B. 1. 1, B. 2. 1, B. 3. 1 and B. 4. 1 provide the necessary distributed vertical steel to resist the out-of-plane loads for below grade ICF walls with 6" tie spacing.
- 5.1.4. Tables B. 1. 2, B. 2. 2, B. 3. 2 and B. 4. 2 provide the necessary distributed vertical steel to resist the out-of-plane loads for below grade ICF walls with 8" tie spacing.
- 5.1.5. Tables A. 1. 1 and A. 2. 1 provide the necessary distributed vertical steel to resist the out-of-plane loads for above grade ICF walls with 6" tie spacing.
- 5.1.6. Tables A. 2. 1 and A. 2. 2 provide the necessary distributed vertical steel to resist the out-of-plane loads for above grade ICF walls with 8" tie spacing.
- 5.1.7. Interpolation within the tables is not permitted.
- 5.1.8. Any table may be used where the local wind and seismic design values do not exceed the maximum values given in the table.
- 5.1.9. All basement walls in a building with a walkout condition shall be reinforced as a below grade wall for the maximum backfill height. Place the reinforcing in the center of the wall where the basement wall does not support any backfill.
- 5.1.10. The vertical distributed reinforcing bar spacing given in millimeters in the tables is the nominal dimension, the bar spacing in inches is the exact dimension. The vertical bar spacing is given as multiples of the form web spacing.
- 5.1.11. For walls below grade, the vertical reinforcing is to be placed on the inside face of the wall as shown in Detail B. 1.
- 5.1.12. For walls above grade, the vertical reinforcing is to be placed in the middle of the wall as shown in Detail A. 1.
- 5.1.13. Walls above grade formed using 300mm (12") forms shall have all distributed steel placed in two equal layers. One layer is to be placed in the exterior third of the wall and the other layer in the interior third of the wall as shown in Detail A. 2.
- 5.1.14. The height of an above grade wall is the distance from the top of the floor connection at its base to the bottom of the floor or roof connection at its top, as shown in Detail A. 12.
- 5.1.15. The height of a below grade wall is the distance from the top of the basement floor slab to the point of bearing for the floor system, as shown in Detail A. 12.
- 5.1.16. Backfill height against a below grade wall is the distance from the top of the basement floor slab to the finished exterior grade level.

- 5.1.17. Alternating horizontal bar spacing of 12" o.c. and 24" o.c. may be used to achieve an average spacing of 18" o.c. where 18" o.c. spacing is specified for horizontal bars as shown in Detail A. 3.
- 5.1.18. Provide three horizontal bars in every two rows of 18" high block to achieve an average spacing of 12" o.c. where 12" spacing o.c. is specified for horizontal bars as shown in Detail A. 4.
- 5.1.19. Provide four horizontal bars in every three rows of 16" high block to achieve an average spacing of 12" o.c. where 12" spacing o.c. is specified for horizontal bars as shown in Detail A. 5.
- 5.1.20. Alternating vertical bar spacing of 8" o.c. and 16" o.c. may be used to achieve an average spacing of 12" o.c. where 12" o.c. spacing is specified for vertical bars as shown in Detail A. 6.
- 5.1.21. Distributed reinforcing in a wall shall not be less than that required for the wall above.

## 5.2. Shear Walls

- 5.2.1. Shear walls are solid ICF wall segments between openings and corners.
- 5.2.2. Openings 150mm (6") in diameter and less are permitted within a shear wall, provided they do not occur within 300mm (12") of the ends of the shear wall.
- 5.2.3. Shear walls are designed for buildings with or without walkout basement. Wall configurations for building without and with walkout basement are shown in Detail A. 7 and Detail A. 8, respectively. Wall configurations for walkout basement walls are shown in Detail A. 9.
- 5.2.4. A minimum number and length of shear walls is required on all four sides of the building on all levels as specified in shear wall tables (A.3 3200 to A.11 800) for above-grade walls where the building area is less than or equal to 3200 ft<sup>2</sup>.

This is to replace the requirements for 100 mm (4'-0") long wall segments at each corner in exterior walls specified in NBCC 9.20.17.2. (1) and 9.20.17.4. (1).

These Tables are designated by area overall of the building footprint as follows:

- Use Tables A.3 3200 to A.11 3200 for building areas between 2,401 sf through 3,200 sf
- Use Tables A.3.2400 to A.11 2400 for building areas between 1,601 sf through 2,400 sf
- Use Tables A.3 1600 to A.11 1600 for building areas between 801 sf through 1,600 sf
- Use Tables A.3. 800 to A.11. 800 for building area 800 sf and under.

- 5.2.5. Below grade walls shall have the same number and length of shear walls as required for the walls immediately above.
- 5.2.6. All walls shall be proportionally and evenly distributed in both the transverse and longitudinal direction of the building.
- 5.2.7. Two 15M full height vertical reinforcing bars are to be installed at the ends of all required shear walls in accordance with Detail A. 10. These bars are referred to as concentrated reinforcement and are in addition to the distributed reinforcement specified elsewhere.
- 5.2.8. Matching dowels are to be provided for the concentrated and distributed vertical reinforcement at the base of all required shear walls into floor below as shown in Detail A. 11.
- 5.2.9. Horizontal reinforcement in shear walls where  $S_{a,ICF} > 0.16$  shall be terminated at the ends of the wall with a standard hook.

### 5.3. Concentrated Point Loads on Walls

- 5.3.1. All point loads, such as concentrated loads created by girder trusses, columns and beams, shall bear directly on top of the concrete wall, and shall not be hung or in any other manner create an eccentric loading on the concrete wall. Provide beam pockets, as necessary.
- 5.3.2. The minimum length of solid wall without openings directly below point loads, such as concentrated loads created by girder trusses, columns and beams, shall be 6'-0". In addition to the wall reinforcing required in the following tables, two additional 15M vertical bars shall be installed directly below the point load. This length of solid wall may contain a corner.
- 5.3.3. Use Table C. 1 for the maximum unfactored point load that can be applied on a solid wall without opening if length of the wall is less than 6'-0".
- 5.3.4. Maximum un-factored point loads given in Table C. 1 are only the wall capacity. It is the responsibility of the roof and floor designer to ensure adequate bearing for all framing members is provided on the concrete walls.

### 5.4. Window and Door Openings

- 5.4.1. The cumulative width of openings in above grade walls shall not be more than 70% of the total wall length.
- 5.4.2. The cumulative width of openings in below grade walls shall not be more than 25% of the total wall length.
- 5.4.3. Openings in below grade walls shall not exceed a maximum width of 1.83m (6'-0") and a maximum height of 0.914m (3'-0").
- 5.4.4. The length of solid wall between two openings in below grade walls shall be equal to the average width of the openings and at least 1.22m (4'-0").
- 5.4.5. A minimum of 2-10M bars is to be installed completely around all sides of openings.
- 5.4.6. Provide additional horizontal reinforcing steel directly above the opening as required for lintels.
- 5.4.7. Horizontal bars above and below the opening shall extend a minimum of 610mm (24") past opening.
- 5.4.8. Vertical bars on each side of the opening shall extend the full height of the wall.
- 5.4.9. Distributed vertical reinforcing steel that is interrupted by an opening shall be replaced by an equal amount of concentrated vertical reinforcing steel with half placed on each side of the opening. The additional steel is to be evenly distributed within a distance equal to half the opening width, up to a maximum of 1.22m (4'-0"), from each side of the opening.
- 5.4.10. If the spacing of the additional concentrated vertical reinforcing required on each side of openings, described in the previous note, is less than 150mm (6"), a local design professional shall be retained to prepare the design in accordance with applicable standards.
- 5.4.11. Provide additional vertical reinforcing at the sides of openings as required at the ends of shear walls.

#### 5.4.1. Lintels

- 5.4.1.1. All concrete wall segments above openings are to be considered lintels.
- 5.4.1.2. The top of all lintels is to be laterally supported by the roof and floor systems, designed by others.
- 5.4.1.3. Lintels shall be a minimum of 200mm (8") deep.

- 5.4.1.4. Lintel bottom reinforcing is to be installed a maximum of 89mm (3½") from the bottom of the lintel and is to extend a minimum of 610mm (24") past the wall opening.
- 5.4.1.5. A minimum of 2-10M bars is to be installed completely around all sides of openings, as shown in Detail L. 1.
- 5.4.1.6. Where stirrups are required for lintels with uniformly distributed load, they shall be single 10M hook stirrups installed around bottom and top bars over the given end distance at each side of the beam as shown in Detail L. 2.
- 5.4.1.7. Where stirrups are required for lintels with concentrated load, they shall be single 10M hook stirrups installed around bottom and top bars over the whole length of the beam. 5.4.1.4.
- 5.4.1.8. Minimum lintel reinforcing is to consist of bottom bars indicated in the design tables, along with horizontal 10M continuous wall reinforcing at 406mm (16") on center, and a minimum of 1-10M top bar located 50mm (2") from the top of the lintel, as shown in Detail L. 3.
- 5.4.1.9. Provide a minimum of three stirrups in all lintels at the spacing indicated in the tables when  $S_{a,ICF} > 0.16$ .
- 5.4.1.10. The lintel design tables are only applicable for uniformly distributed gravity line loads and point loads, such as concentrated loads created by girder trusses, columns and beams.
- 5.4.1.11. Concentrated load lintel tables consider only a single concentrated load acting on anywhere along the lintel span.
- 5.4.1.12. The lintel tables do not consider uniform and concentrated load to act simultaneously on the lintel.
- 5.4.1.13. The uniformly distributed load (UDL) is calculated by multiplying the roof and/or floor loads, including snow load (SL), live load (LL) and dead load (DL), by the tributary width (TW) of the roof and/or floor. The tributary width is determined by adding half the span of each rafter/joist bearing on the concrete lintel. For example, the UDL for a lintel supporting floor joists spanning 10'-0" and roof trusses spanning 30'-0" on one side only is calculated as follows:
- $$UDL = TW_{FLOOR} * (LL_{FLOOR} + DL_{FLOOR}) + TW_{ROOF} * (SL_{ROOF} + DL_{ROOF})$$
- $$UDL = (10 \text{ ft}/2) * (40 \text{ psf} + 15 \text{ psf}) + (30 \text{ ft}/2) * (84 \text{ psf} + 15 \text{ psf})$$
- $$UDL = 275 \text{ lbs}/\text{ft} + 1485 \text{ lbs}/\text{ft} = 1760 \text{ lbs}/\text{ft}$$
- 5.4.1.14. The weight of walls above the lintel has been included in the design of the lintel tables and does not need to be added to the UDL calculated as described above.
- 5.4.1.15. Where there is less than 305mm (12") of wall between openings, the lintel shall be reinforced to span over both openings, as shown in Detail L. 4.
- 5.4.1.16. Where there is less than 610mm (24") of wall between openings, and openings are greater than 1.53m (5'-0") in length, the lintel shall be reinforced to span over both openings, as shown in Detail L. 5.

## 5.5. Stair Openings

- 5.5.1. Additional reinforcement is to be provided in exterior walls where a stair opening interrupts the required lateral support provided by the floor framing.
- 5.5.2. Table A. 12. provides the maximum dimension of stair opening parallel to the wall and the required horizontal reinforcement of above grade walls at stair opening.
- 5.5.3. Table B. 5. provides the maximum dimension of stair opening parallel to the wall and the required horizontal reinforcement of below grade walls at stair opening. Below grade walls at stair openings are designed for a backfill equivalent fluid density of 480 kg/m<sup>3</sup> and a maximum  $S_a(0.2)$

of 0.7. Reinforcement design of below grade walls at stair openings shall be reviewed by a professional engineer if the wall does not meet the requirement of this table.

- 5.5.4. Lateral restraint of the wall is to be provided by the floor framing on each side of the stair opening, by others.
- 5.5.5. The spacing of distributed vertical reinforcement is to be reduced for a distance of 1.22m (4'-0") on each side of the stair opening for above grade and below grade walls. The required spacing is calculated by the following equation and listed in Table A. 13.

$$S_{\text{REDUCED}} = 2.44 / (L_{\text{UNSUPPORTED}} + 2.44) * S_{\text{TABLES}} \quad (\text{METRIC})$$

$$S_{\text{REDUCED}} = 8 / (L_{\text{UNSUPPORTED}} + 8) * S_{\text{TABLES}} \quad (\text{IMPERIAL})$$

where

$S_{\text{REDUCED}}$  = the bar spacing (mm/in) required at the sides of the stair opening.

$S_{\text{TABLES}}$  = the required bar spacing (mm/in) for a laterally supported wall as determined from above grade and below grade walls tables.

$L_{\text{UNSUPPORTED}}$  = the length of wall (m/ft) that is laterally unsupported as a result of a stair opening in the floor framing.

- 5.5.6. If the stair opening is out of the scope of design limitations for stair opening table, additional distributed horizontal reinforcing bars are to be added at the stair opening as specified by a professional engineer.

## 5.6. Laterally Supported Unreinforced Foundation Wall

- 5.6.1. Foundation walls in this section are designed for backfill equivalent fluid density of 480 kg/m<sup>3</sup> in accordance with section 9.4.4.6 of NBCC 2020.
- 5.6.2. If the foundation wall is laterally supported at the top (e.g. by floor joists) and meets all the requirements of NBCC 2020 section 9.15.4, and supports only wood frame construction above, a 20 MPa unreinforced concrete wall is adequate for the specific wall and backfill height, as per NBCC 2020 table 9.15.4.2.A, shown in Detail B. 2.

- 5.6.3. Use below grade wall tables if the height of the wall and / or backfilled soil is greater than the maximum values of Table B. 6.

- 5.6.4. Use below grade wall tables for walls supporting ICF wall above.

## 5.7. Laterally Unsupported Foundation Walls (Knee Wall) with Wood Framing Above

- 5.7.1. If the foundation wall is not supported at the top (e.g. by floor joists) and supports only wood frame construction above, the design can follow the knee wall design as shown in Details B.3 and B.4. The design includes both the footing sizing and reinforcing of the footing and wall.
- 5.7.2. If heights of backfilled soil and / or foundation wall are greater than what shown in these details, reinforcement design of the wall must be reviewed by a professional engineer.
- 5.7.3. Foundations are to bear directly on material suitable for 75 kPa (1566 psf) bearing pressure.

## 6. Wood Ledger Connection

- 6.1. Anchor bolts are designed to transfer vertical load of floor to the ICF wall. Design of floor diaphragm by others.



- 6.2. Design loads are 40psf (1.9 kPa) floor live load, 15psf (0.7 kPa) floor dead load.
- 6.3. Anchor bolts are to be staggered as shown in Detail C. 1. Use Table C. 2. for size and spacing of the anchors.

## 7. Brick Ledge

- 7.1. The concrete ledge is to support uniformly distributed loads only. It is not to support concentrated load. A brick ledge section is shown in Detail C. 2.
- 7.2. Table C. 3. provide the brick ledge capacity as the total height of brick veneer or tributary width of a floor that can be supported per unit length of the brick ledge.
- 7.3. The capacity given in Table C. 3. is only for the capacity of the brick ledge. The veneer height may be limited by other building code requirement or manufacturer's installation requirements.
- 7.4. The above grade and below grade wall reinforcing tables include the effects of using the ledge to support floor framing.
- 7.5. The below grade wall reinforcing tables include the effects of using the ledge to support masonry veneer.
- 7.6. The maximum brick height given does not account for windows. To include the effect of windows, it is necessary to calculate an effective brick height.
- 7.7. The ledge reinforcement is 10M hooked rebar, as shown in Detail C. 2 or FOXBLOCKS xLerator as shown in Detail C. 3. It is to be placed 6" or 8" on center matching the tie spacing of ICF blocks.

## 8. Strip Footing

- 8.1. Tables F. 2. to F. 4. provide minimum width and thickness of footing for different loadings and soil bearing pressures.
- 8.2. Soft areas uncovered during excavation shall be sub-excavated to sound material and filled with clean and free drained granular soil.
- 8.3. Protect soil from freezing adjacent to and below all footings.
- 8.4. All footings are to be reinforced with 2-15M continuous bars, as per Detail F. 1.
- 8.5. Tables F. 2. to F. 4. do not include masonry veneer. Increase the footing width by 2" and the thickness by 1" for:
  - a. Every 12'-0" of masonry veneer for 3000psf soil bearing capacity.
  - b. Every 10'-0" of masonry veneer for 2500psf soil bearing capacity.
  - c. Every 8'-0" of masonry veneer for 2000psf soil bearing capacity.
  - d. Every 6'-0" of masonry veneer for 1500psf soil bearing capacity.
- 8.6. The footing size for locations with  $S_a(0.2) > 0.4$  to be the larger of 30" wide by 12" deep or the size shown in the table.
- 8.7. Provide footing dowels as shown in Detail F. 1.
- 8.8. Footing dowels are 10M or 15M bars embedded 6" or 8" into the footing. Dowels size and spacing is given in Table F. 1.

- 8.9. Provide bent dowels as per Note. 4 of Table F. 1, at shear walls locations matching the size and spacing of vertical bars of the shear walls.

**ICFMA**

**INSULATING CONCRETE FORMS  
MANUFACTURERS ASSOCIATION**

## List of Details

Detail B. 1. Below Grade Wall Reinforcing Placement for All Wall Thicknesses.....	22
Detail A. 1. Above Grade Wall Reinforcing Placement for 6", 8" And 10" Thick Walls.....	23
Detail A. 2. Above Grade Wall Reinforcing Placement for 12" Thick Walls.....	24
Detail A. 3. Alternating Horizontal Bar Spacing of 12" O.C. and 24" O.C. to Achieve an Average Spacing of 18" O.C. (Two Horizontal Bars in Every Three Rows of ICF Blocks) .....	25
Detail A. 4. Three Horizontal Bars in Every Two Rows of 18" High Block to Achieve an Average Spacing of 12" O.C.....	25
Detail A. 5. Four Horizontal Bars in Every Three Rows of 16" High Block to Achieve an Average Spacing of 12" O.C.....	26
Detail A. 6. Alternating Vertical Bar Spacing of 8" O.C. and 16" O.C. to Achieve an Average Spacing of 12" O.C. (Two Vertical Bars in Every Three Cells) .....	26
Detail A. 7. Wall Configurations in a Building Without Walkout Basement.....	27
Detail A. 8. Wall Configurations in a Building with Walkout Basement.....	29
Detail A. 9. Walkout Basement Wall Configurations.....	32
Detail A. 10. Shear Wall Distributed and Concentrated Vertical Reinforcing Placement.....	36
Detail A. 11. Shear Wall Dowels.....	37
Detail A. 12. Above and Below Grade Wall Height.....	38
Detail L. 1. Reinforcing Around Openings.....	95
Detail L. 2. Lintel Stirrup Detail.....	96
Detail L. 3. Lintel Section .....	96
Detail L. 4. Lintel Span with Less Than 305mm (12") of Wall Between Openings.....	97
Detail L. 5. Lintel Span with Less Than 610mm (24") of Wall Between Openings, and Openings Are Greater Than 1.53m (5'-0") in Length.....	97
Detail B. 2. Laterally Supported Foundation Wall.....	126
Detail B. 3. Laterally Unsupported Foundation Wall (Knee Wall).....	127
Detail B. 4. Laterally Unsupported Foundation Wall (Knee Wall) with Brick Veneer.....	128
Detail C. 1. Wood Ledger Connection .....	129
Detail C. 2. Brick Ledge Connection .....	130
Detail C. 3. FOXBLOCKS xLerator Ledge Reinforcement .....	130
Detail F. 1. Footing Dowel.....	132

## List of Tables

Table B.1.1.– Below Grade Wall Distributed Reinforcement for Seismic Zone Classification, $S_{a,ICF} \leq 0.11$ and Hourly Wind Pressure, $q_{1/50} \leq 1.05kPa$ , for ICF Walls with 6” Tie Spacing.....	39
Table B.1.1. Continued – Below Grade Wall Distributed Reinforcement for Seismic Zone Classification, $S_{a,ICF} \leq 0.11$ and Hourly Wind Pressure, $q_{1/50} \leq 1.05kPa$ , for ICF Walls with 6” Tie Spacing .....	40
Table B.1.2.– Below Grade Wall Distributed Reinforcement for Seismic Zone Classification, $S_{a,ICF} \leq 0.11$ and Hourly Wind Pressure, $q_{1/50} \leq 1.05kPa$ , for ICF Walls with 8” Tie Spacing.....	41
Table B.1.2. Continued – Below Grade Wall Distributed Reinforcement for Seismic Zone Classification, $S_{a,ICF} \leq 0.11$ and Hourly Wind Pressure, $q_{1/50} \leq 1.05kPa$ , for ICF Walls with 8” Tie Spacing .....	42
Table B.2.1. – Below Grade Wall Distributed Reinforcement for Seismic Zone Classification, $0.11 < S_{a,ICF} \leq 0.16$ and Hourly Wind Pressure, $q_{1/50} \leq 1.05kPa$ , for ICF Walls with 6” Tie Spacing.....	43
Table B.2.1. Continued – Below Grade Wall Distributed Reinforcement for Seismic Zone Classification, $0.11 < S_{a,ICF} \leq 0.16$ and Hourly Wind Pressure, $q_{1/50} \leq 1.05kPa$ , for ICF Walls with 6” Tie Spacing .....	44
Table B.2.2. – Below Grade Wall Distributed Reinforcement for Seismic Zone Classification, $0.11 < S_{a,ICF} \leq 0.16$ and Hourly Wind Pressure, $q_{1/50} \leq 1.05kPa$ , for ICF Walls with 8” Tie Spacing.....	45
Table B.2.2. Continued – Below Grade Wall Distributed Reinforcement for Seismic Zone Classification, $0.11 < S_{a,ICF} \leq 0.16$ and Hourly Wind Pressure, $q_{1/50} \leq 1.05kPa$ , for ICF Walls with 8” Tie Spacing .....	46
Table B.3.1. – Below Grade Wall Distributed Reinforcement for Seismic Zone Classification, $0.16 < S_{a,ICF} \leq 0.31$ and Hourly Wind Pressure, $q_{1/50} \leq 1.05kPa$ , for ICF Walls with 6” Tie Spacing.....	47
Table B.3.1. Continued – Below Grade Wall Distributed Reinforcement for Seismic Zone Classification, $0.16 < S_{a,ICF} \leq 0.31$ and Hourly Wind Pressure, $q_{1/50} \leq 1.05kPa$ , for ICF Walls with 6” Tie Spacing .....	48
Table B.3.2. – Below Grade Wall Distributed Reinforcement for Seismic Zone Classification, $0.16 < S_{a,ICF} \leq 0.31$ and Hourly Wind Pressure, $q_{1/50} \leq 1.05kPa$ , for ICF Walls with 8” Tie Spacing.....	49
Table B.3.2. Continued– Below Grade Wall Distributed Reinforcement for Seismic Zone Classification, $0.16 < S_{a,ICF} \leq 0.31$ and Hourly Wind Pressure, $q_{1/50} \leq 1.05kPa$ , for ICF Walls with 8” Tie Spacing .....	50
Table B.4.1. – Below Grade Wall Distributed Reinforcement for Seismic Zone Classification, $0.31 < S_{a,ICF} \leq 0.79$ and Hourly Wind Pressure, $q_{1/50} \leq 1.05kPa$ , for ICF Walls with 6” Tie Spacing.....	51
Table B.4.1. Continued– Below Grade Wall Distributed Reinforcement for Seismic Zone Classification, $0.31 < S_{a,ICF} \leq 0.79$ and Hourly Wind Pressure, $q_{1/50} \leq 1.05kPa$ , for ICF Walls with 6” Tie Spacing .....	52
Table B.4.2. – Below Grade Wall Distributed Reinforcement for Seismic Zone Classification, $0.31 < S_{a,ICF} \leq 0.79$ and Hourly Wind Pressure, $q_{1/50} \leq 1.05kPa$ , for ICF Walls with 8” Tie Spacing.....	53
Table B.4.2. Continued– Below Grade Wall Distributed Reinforcement for Seismic Zone Classification, $0.31 < S_{a,ICF} \leq 0.79$ and Hourly Wind Pressure, $q_{1/50} \leq 1.05kPa$ , for ICF Walls with 8” Tie Spacing .....	54
Table A.1.1. Above Grade Wall Distributed Reinforcement for Seismic Zone Classification, $S_{a,ICF} \leq 0.16$ and Hourly Wind Pressure, $q_{1/50} \leq 1.05kPa$ , for ICF Walls with 6” Tie Spacing.....	55
Table A.1.2. Above Grade Wall Distributed Reinforcement for Seismic Zone Classification, $S_{a,ICF} \leq 0.16$ and Hourly Wind Pressure, $q_{1/50} \leq 1.05kPa$ , for ICF Walls with 8” Tie Spacing.....	56
Table A.2.1. Above Grade Wall Distributed Reinforcement for Seismic Zone Classification, $S_{a,ICF} > 0.16$ and Hourly Wind Pressure, $q_{1/50} \leq 1.05kPa$ for, ICF Walls with 6” Tie Spacing.....	57

Table A.2.2. Above Grade Wall Distributed Reinforcement for Seismic Zone Classification, $S_{a,ICF} > 0.16$ and Hourly Wind Pressure, $q_{1/50} \leq 1.05\text{kPa}$ for, ICF Walls with 8" Tie Spacing.....	58
Table A.3.3200. Above Grade Shear Wall Length for Seismic Zone Classification, $S_{a,ICF} \leq 0.16$ and Hourly Wind Pressure, $q_{1/50} \leq 0.5\text{kPa}$ (in a Building Without Walkout Basement), where Building Area $\leq 3200\text{ft}^2$ .....	59
Table A.4.3200. Above Grade Shear Wall Length for Seismic Zone Classification, $S_{a,ICF} \leq 0.16$ and Hourly Wind Pressure, $0.5\text{kPa} < q_{1/50} \leq 0.75\text{kPa}$ (in a Building Without Walkout Basement), where Building Area $\leq 3200\text{ft}^2$ .....	60
Table A.5.3200. Above Grade Shear Wall Length for Seismic Zone Classification, $S_{a,ICF} \leq 0.16$ and Hourly Wind Pressure, $0.5\text{kPa} < q_{1/50} \leq 0.75\text{kPa}$ (in a Building Without Walkout Basement), where Building Area $\leq 3200\text{ft}^2$ .....	61
Table A.6.3200. Above Grade Shear Wall Length for Seismic Zone Classification, $S_{a,ICF} > 0.16$ and Hourly Wind Pressure, $q_{1/50} \leq 1.05\text{kPa}$ (in a Building Without Walkout Basement), where Building Area $\leq 3200\text{ft}^2$ .....	62
Table A.7.3200. Above Grade Shear Wall Length for Seismic Zone Classification, $S_{a,ICF} \leq 0.16$ and Hourly Wind Pressure, $q_{1/50} \leq 0.5\text{kPa}$ (in a Building With Walk Basement), where Building Area $\leq 3200\text{ft}^2$ .....	63
Table A.8.3200. Above Grade Shear Wall Length for Seismic Zone Classification, $S_{a,ICF} \leq 0.16$ and Hourly Wind Pressure, $0.5\text{kPa} < q_{1/50} \leq 0.75\text{kPa}$ (in a Building With Walkout Basement), where Building Area $\leq 3200\text{ft}^2$ .....	64
Table A.9.3200. Above Grade Shear Wall Length for Seismic Zone Classification, $S_{a,ICF} \leq 0.16$ and Hourly Wind Pressure, $0.75\text{kPa} < q_{1/50} \leq 1.05\text{kPa}$ (in a Building With Walkout Basement), where Building Area $\leq 3200\text{ft}^2$ .....	65
Table A.10.3200. Above Grade Shear Wall Length for Seismic Zone Classification, $S_{a,ICF} > 0.16$ and Hourly Wind Pressure, $q_{1/50} \leq 1.05\text{kPa}$ (in a Building With Walkout Basement), where Building Area $\leq 3200\text{ft}^2$ .....	66
Table A. 11.3200. – Above Grade Walkout Basement Shear Wall Length for Seismic Zone Classification, $S_{a,ICF} \leq 0.31$ and Hourly Wind Pressure, $q_{1/50} \leq 1.05\text{kPa}$ , where Building Area $\leq 3200\text{ft}^2$ .....	67
Table A.3.2400. Above Grade Shear Wall Length for Seismic Zone Classification, $S_{a,ICF} \leq 0.16$ and Hourly Wind Pressure, $q_{1/50} \leq 0.5\text{kPa}$ (in a Building Without Walkout Basement), where Building Area $\leq 2400\text{ft}^2$ .....	68
Table A.4.2400. Above Grade Shear Wall Length for Seismic Zone Classification, $S_{a,ICF} \leq 0.16$ and Hourly Wind Pressure, $0.5\text{kPa} < q_{1/50} \leq 0.75\text{kPa}$ (in a Building Without Walkout Basement), where Building Area $\leq 2400\text{ft}^2$ .....	69
Table A.5.2400. Above Grade Shear Wall Length for Seismic Zone Classification, $S_{a,ICF} \leq 0.16$ and Hourly Wind Pressure, $0.5\text{kPa} < q_{1/50} \leq 0.75\text{kPa}$ (in a Building Without Walkout Basement), where Building Area $\leq 2400\text{ft}^2$ .....	70
Table A.6.2400. Above Grade Shear Wall Length for Seismic Zone Classification, $S_{a,ICF} > 0.16$ and Hourly Wind Pressure, $q_{1/50} \leq 1.05\text{kPa}$ (in a Building Without Walkout Basement), where Building Area $\leq 2400\text{ft}^2$ .....	71
Table A.7.2400. Above Grade Shear Wall Length for Seismic Zone Classification, $S_{a,ICF} \leq 0.16$ and Hourly Wind Pressure, $q_{1/50} \leq 0.5\text{kPa}$ (in a Building With Walk Basement), where Building Area $\leq 2400\text{ft}^2$ .....	72
Table A.8.2400. Above Grade Shear Wall Length for Seismic Zone Classification, $S_{a,ICF} \leq 0.16$ and Hourly Wind Pressure, $0.5\text{kPa} < q_{1/50} \leq 0.75\text{kPa}$ (in a Building With Walkout Basement), where Building Area $\leq 2400\text{ft}^2$ .....	73
Table A.9.2400. Above Grade Shear Wall Length for Seismic Zone Classification, $S_{a,ICF} \leq 0.16$ and Hourly Wind Pressure, $0.75\text{kPa} < q_{1/50} \leq 1.05\text{kPa}$ (in a Building With Walkout Basement), where Building Area $\leq 2400\text{ft}^2$ .....	74

Table A.10.2400. Above Grade Shear Wall Length for Seismic Zone Classification, $S_{a,ICF} > 0.16$ and Hourly Wind Pressure, $q1/50 \leq 1.05kPa$ (in a Building With Walkout Basement), where Building Area $\leq 2400ft^2$ .....	75
Table A. 11.2400. – Above Grade Walkout Basement Shear Wall Length for Seismic Zone Classification, $S_{a,ICF} \leq 0.31$ and Hourly Wind Pressure, $q1/50 \leq 1.05kPa$ , where Building Area $\leq 2400ft^2$ .....	76
Table A.3.1600. Above Grade Shear Wall Length for Seismic Zone Classification, $S_{a,ICF} \leq 0.16$ and Hourly Wind Pressure, $q1/50 \leq 0.5kPa$ (in a Building Without Walkout Basement), where Building Area $\leq 1600ft^2$ .....	77
Table A.4.1600. Above Grade Shear Wall Length for Seismic Zone Classification, $S_{a,ICF} \leq 0.16$ and Hourly Wind Pressure, $0.5kPa < q1/50 \leq 0.75kPa$ (in a Building Without Walkout Basement), where Building Area $\leq 1600ft^2$ .....	78
Table A.5.1600. Above Grade Shear Wall Length for Seismic Zone Classification, $S_{a,ICF} \leq 0.16$ and Hourly Wind Pressure, $0.5kPa < q1/50 \leq 0.75kPa$ (in a Building Without Walkout Basement), where Building Area $\leq 1600ft^2$ .....	79
Table A.6.1600. Above Grade Shear Wall Length for Seismic Zone Classification, $S_{a,ICF} > 0.16$ and Hourly Wind Pressure, $q1/50 \leq 1.05kPa$ (in a Building Without Walkout Basement), where Building Area $\leq 1600ft^2$ .....	80
Table A.7.1600. Above Grade Shear Wall Length for Seismic Zone Classification, $S_{a,ICF} \leq 0.16$ and Hourly Wind Pressure, $q1/50 \leq 0.5kPa$ (in a Building With Walk Basement), where Building Area $\leq 1600ft^2$ .....	81
Table A.8.1600. Above Grade Shear Wall Length for Seismic Zone Classification, $S_{a,ICF} \leq 0.16$ and Hourly Wind Pressure, $0.5kPa < q1/50 \leq 0.75kPa$ (in a Building With Walkout Basement), where Building Area $\leq 1600ft^2$ .....	82
Table A.9.1600. Above Grade Shear Wall Length for Seismic Zone Classification, $S_{a,ICF} \leq 0.16$ and Hourly Wind Pressure, $0.75kPa < q1/50 \leq 1.05kPa$ (in a Building With Walkout Basement), where Building Area $\leq 1600ft^2$ .....	83
Table A.10.1600. Above Grade Shear Wall Length for Seismic Zone Classification, $S_{a,ICF} > 0.16$ and Hourly Wind Pressure, $q1/50 \leq 1.05kPa$ (in a Building With Walkout Basement), where Building Area $\leq 1600ft^2$ .....	84
Table A. 11.1600. – Above Grade Walkout Basement Shear Wall Length for Seismic Zone Classification, $S_{a,ICF} \leq 0.31$ and Hourly Wind Pressure, $q1/50 \leq 1.05kPa$ , where Building Area $\leq 1600ft^2$ .....	85
Table A.3.800. Above Grade Shear Wall Length for Seismic Zone Classification, $S_{a,ICF} \leq 0.16$ and Hourly Wind Pressure, $q1/50 \leq 0.5kPa$ (in a Building Without Walkout Basement), where Building Area $\leq 800ft^2$ .....	86
Table A.4.800. Above Grade Shear Wall Length for Seismic Zone Classification, $S_{a,ICF} \leq 0.16$ and Hourly Wind Pressure, $0.5kPa < q1/50 \leq 0.75kPa$ (in a Building Without Walkout Basement), where Building Area $\leq 800ft^2$ .....	87
Table A.5.800. Above Grade Shear Wall Length for Seismic Zone Classification, $S_{a,ICF} \leq 0.16$ and Hourly Wind Pressure, $0.5kPa < q1/50 \leq 0.75kPa$ (in a Building Without Walkout Basement), where Building Area $\leq 800ft^2$ .....	88
Table A.6.800. Above Grade Shear Wall Length for Seismic Zone Classification, $S_{a,ICF} > 0.16$ and Hourly Wind Pressure, $q1/50 \leq 1.05kPa$ (in a Building Without Walkout Basement), where Building Area $\leq 800ft^2$ .....	89
Table A.7.800. Above Grade Shear Wall Length for Seismic Zone Classification, $S_{a,ICF} \leq 0.16$ and Hourly Wind Pressure, $q1/50 \leq 0.5kPa$ (in a Building With Walk Basement), where Building Area $\leq 800ft^2$ .....	90

Table A.8.800. Above Grade Shear Wall Length for Seismic Zone Classification, $S_{a,ICF} \leq 0.16$ and Hourly Wind Pressure, $0.5kPa < q_{1/50} \leq 0.75kPa$ (in a Building With Walkout Basement), where Building Area $\leq 800ft^2$ .....	91
Table A.9.800. Above Grade Shear Wall Length for Seismic Zone Classification, $S_{a,ICF} \leq 0.16$ and Hourly Wind Pressure, $0.75kPa < q_{1/50} \leq 1.05kPa$ (in a Building With Walkout Basement), where Building Area $\leq 800ft^2$ .....	92
Table A.10.800. Above Grade Shear Wall Length for Seismic Zone Classification, $S_{a,ICF} > 0.16$ and Hourly Wind Pressure, $q_{1/50} \leq 1.05kPa$ (in a Building With Walkout Basement), where Building Area $\leq 800ft^2$ .....	93
Table A. 11.800. – Above Grade Walkout Basement Shear Wall Length for Seismic Zone Classification, $S_{a,ICF} \leq 0.31$ and Hourly Wind Pressure, $q_{1/50} \leq 1.05kPa$ , where Building Area $\leq 800ft^2$ ....	94
Table L. 1. 6” Lintel Reinforcement with Uniformly Distributed Load .....	98
Table L. 2. 8” Lintel Reinforcement with Uniformly Distributed Load .....	101
Table L. 3. 10” Lintel Reinforcement with Uniformly Distributed Load .....	104
Table L. 4. 12” Lintel Reinforcement with Uniformly Distributed Load .....	107
Table L. 5. 6” Lintel Reinforcement with Concentrated Load .....	110
Table L. 6. 8” Lintel Reinforcement with Concentrated Load .....	113
Table L. 7. 10” Lintel Reinforcement with Concentrated Load .....	116
Table L. 8. 12” Lintel Reinforcement with Concentrated Load .....	119
Table C. 1. Maximum Un-Factored Point Load on a Solid Wall Without Opening .....	122
Table A. 12. Above Grade Wall Distributed Horizontal Reinforcement at Stair Openings .....	123
Table B. 5. Below Grade Wall Distributed Horizontal Reinforcement at Stair Opening for Seismic Zone Classification $S_a(0.2) \leq 0.7$ , Hourly Wind Pressure , $q_{1/50} \leq 1.05 kPa$ , and Backfill .....	124
Table A. 13. Bar Spacing Required at Each Side of the Stair Opening .....	125
Table B. 6. Maximum Height of Finish Ground Above Basement Floor .....	126
Table C. 2. Floor Ledger Anchor Bolts Size and Spacing .....	129
Table C. 3. Brick Ledge Load Capacity .....	131
Table F. 1. Footing Dowels Size and Spacing .....	132
Table F. 2. Minimum Exterior Strip Footing Sizes Not Supporting Roof Loads .....	133
Table F. 3. Minimum Exterior Strip Footing Sizes Supporting Roof Snow Loads $\leq 2kPa$ .....	134
Table F. 4. Minimum Exterior Strip Footing Sizes Supporting Roof Snow Loads $\leq 4kPa$ .....	135

## Below & Above Grade Walls Details and Tables

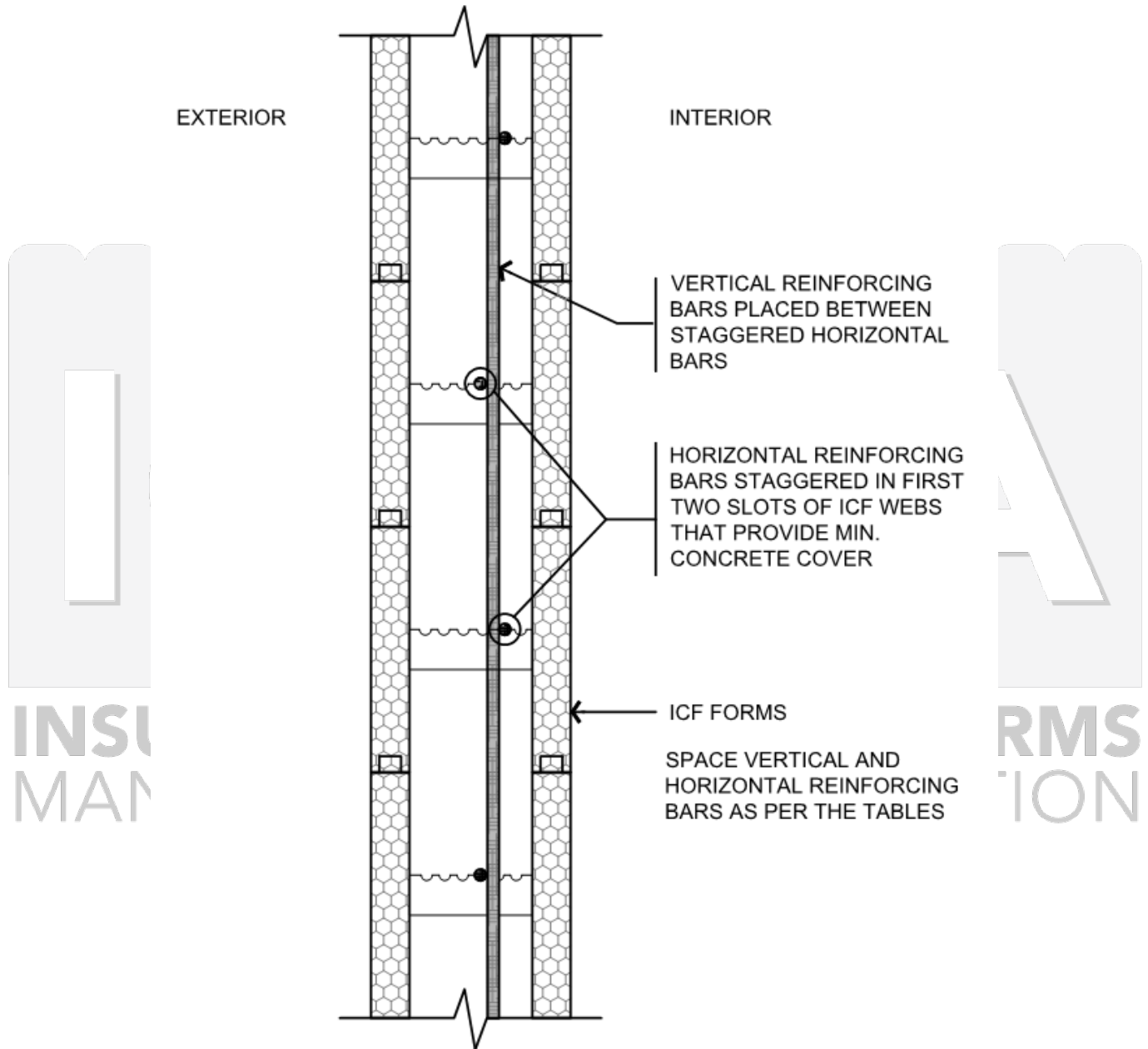

**Detail B. 1. Below Grade Wall Reinforcing Placement for All Wall Thicknesses.**



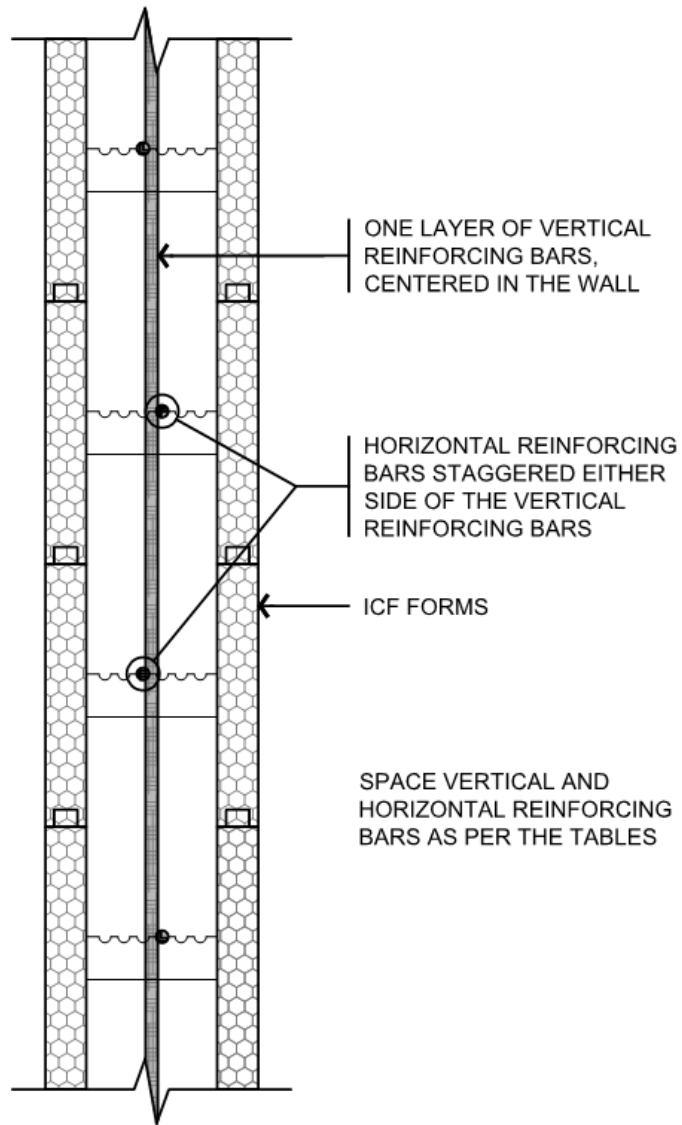

**Detail A. 1. Above Grade Wall Reinforcing Placement for 6", 8" And 10" Thick Walls.**

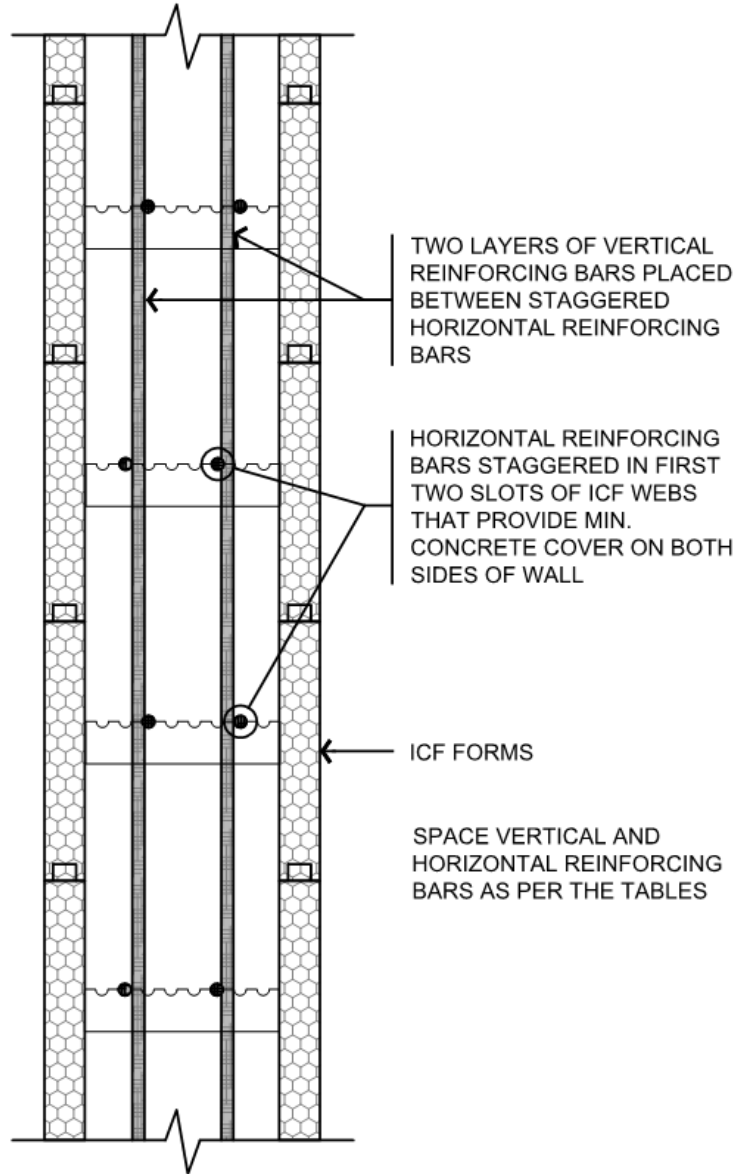

**Detail A. 2. Above Grade Wall Reinforcing Placement for 12" Thick Walls.**

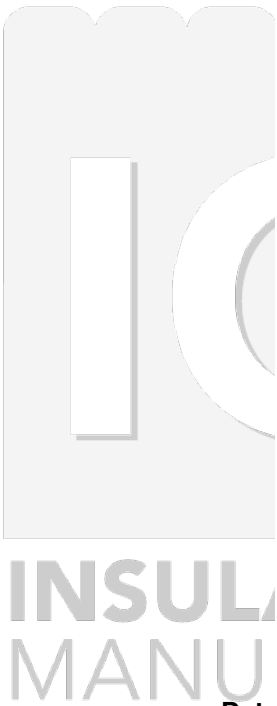

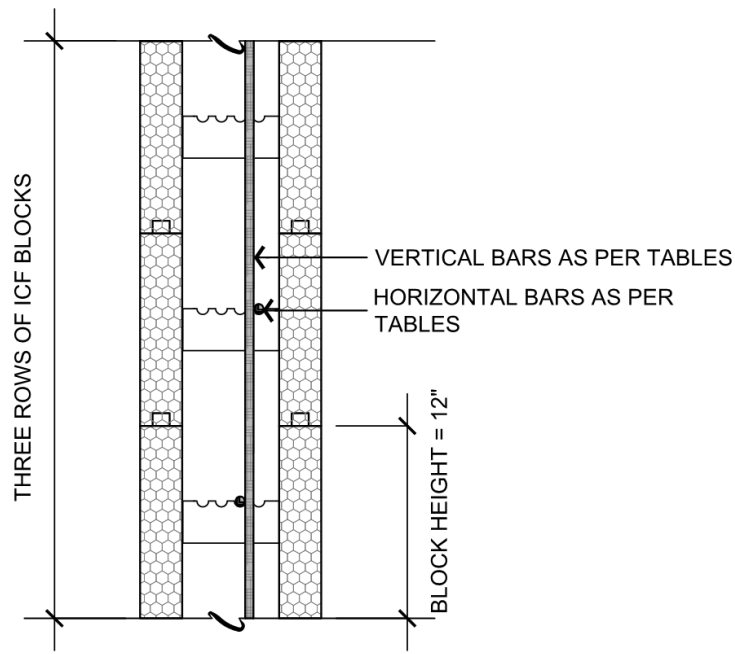

**Detail A. 3. Alternating Horizontal Bar Spacing of 12" O.C. and 24" O.C. to Achieve an Average Spacing of 18" O.C. (Two Horizontal Bars in Every Three Rows of ICF Blocks)**

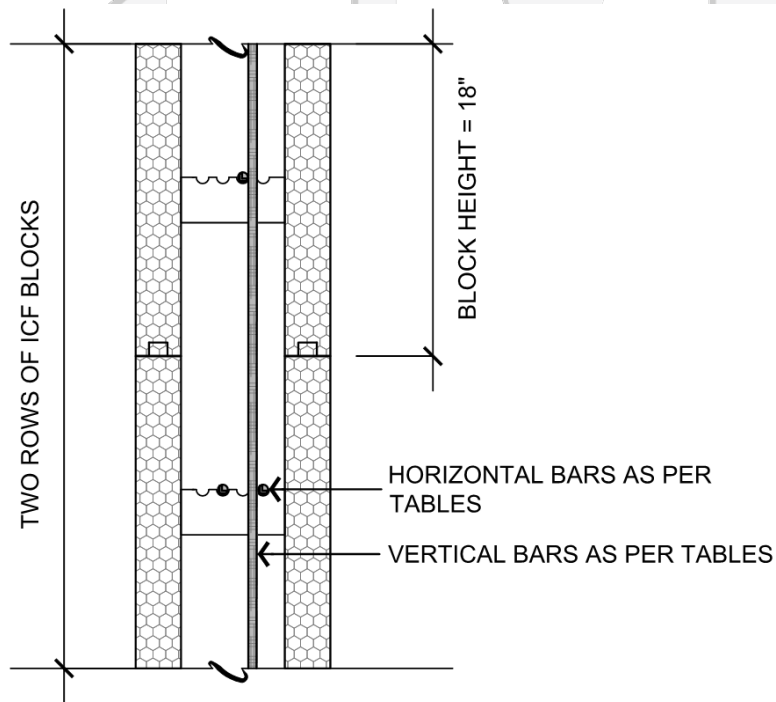

**Detail A. 4. Three Horizontal Bars in Every Two Rows of 18" High Block to Achieve an Average Spacing of 12" O.C.**

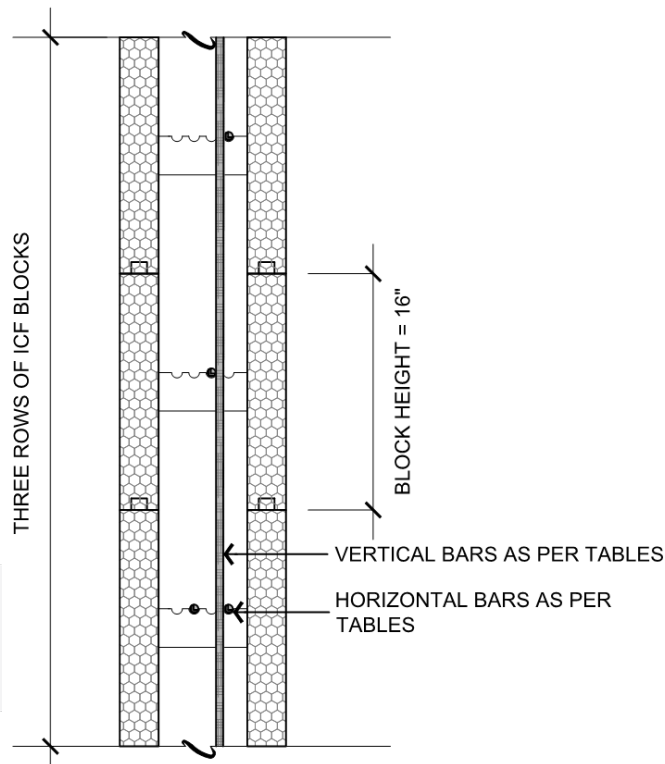

**Detail A. 5. Four Horizontal Bars in Every Three Rows of 16" High Block to Achieve an Average Spacing of 12" O.C.**

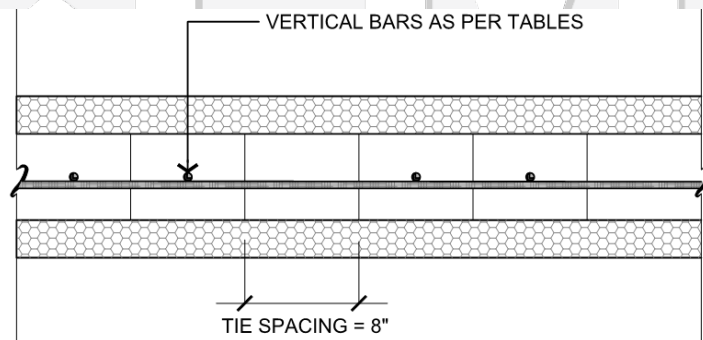

**Detail A. 6. Alternating Vertical Bar Spacing of 8" O.C. and 16" O.C. to Achieve an Average Spacing of 12" O.C. (Two Vertical Bars in Every Three Cells)**

**Detail A. 7. Wall Configurations in a Building Without Walkout Basement**

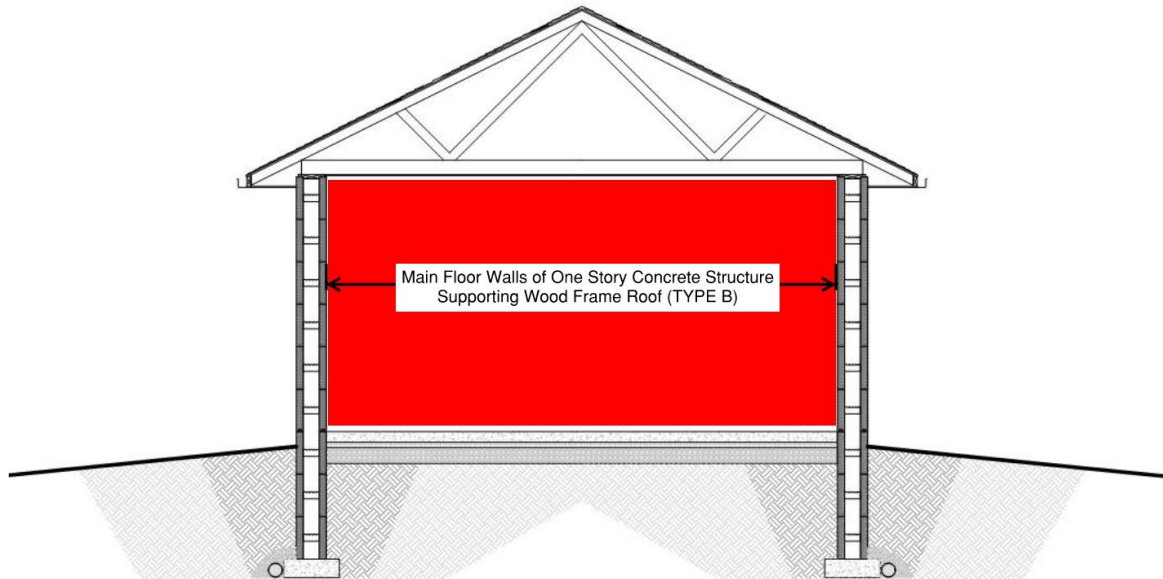

**Detail A. 7. 1. Main Floor Walls of One Story ICF Structure Supporting Wood Frame Roof (TYPE B).**

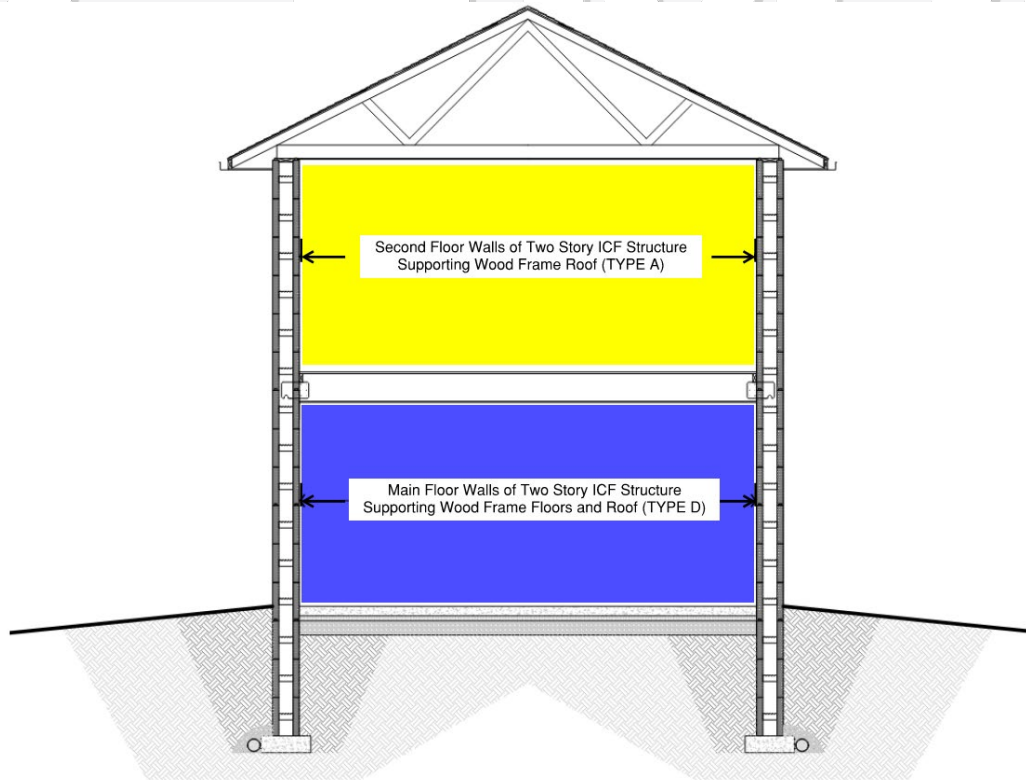

**Detail A. 7. 2. Second Floor Walls of a Two-Story ICF Structure Supporting Wood Frame Roof & Main Floor Walls of a Two-Story ICF Structure Supporting Wood Frame Floors and Roof (TYPE A & D).**

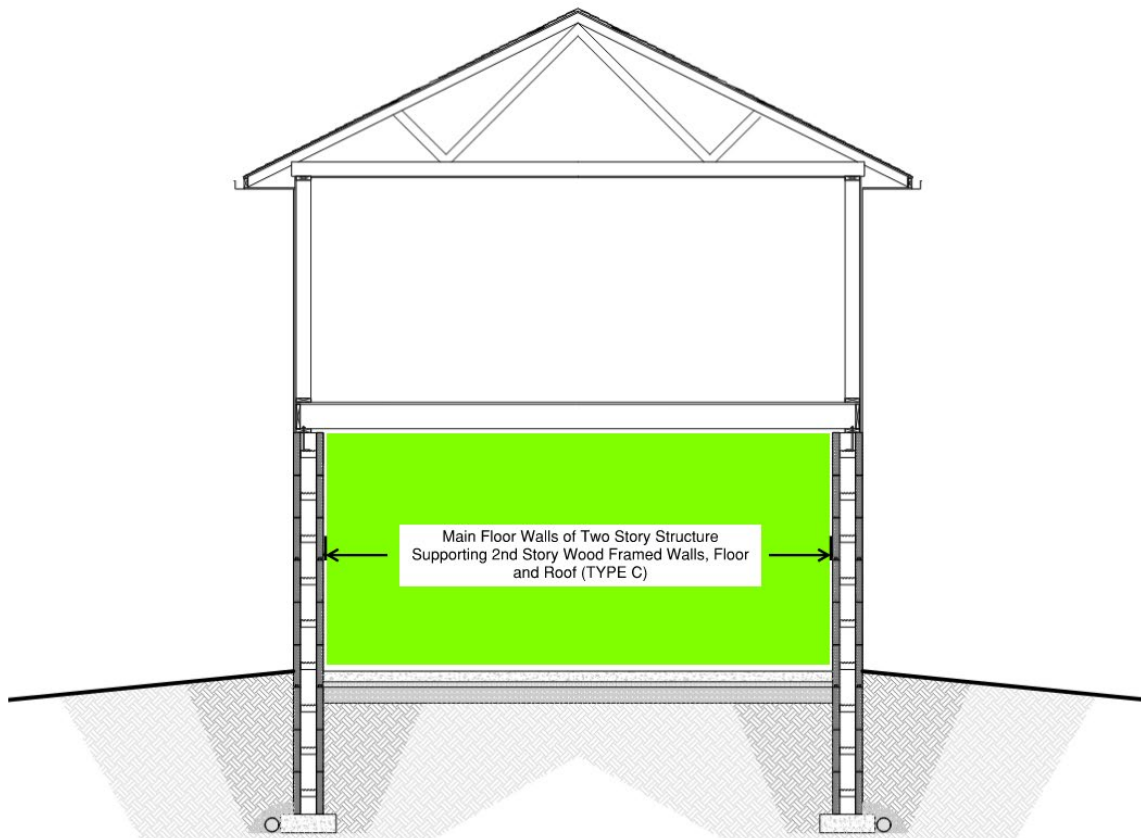

Detail A. 7. 3. Main Floor Walls of a Two-Story Structure Supporting 2<sup>nd</sup> Story Wood Frame Walls, Floor and Roof (TYPE C).

# INSULATING CONCRETE FORMS MANUFACTURERS ASSOCIATION

**Detail A. 8. Wall Configurations in a Building with Walkout Basement**

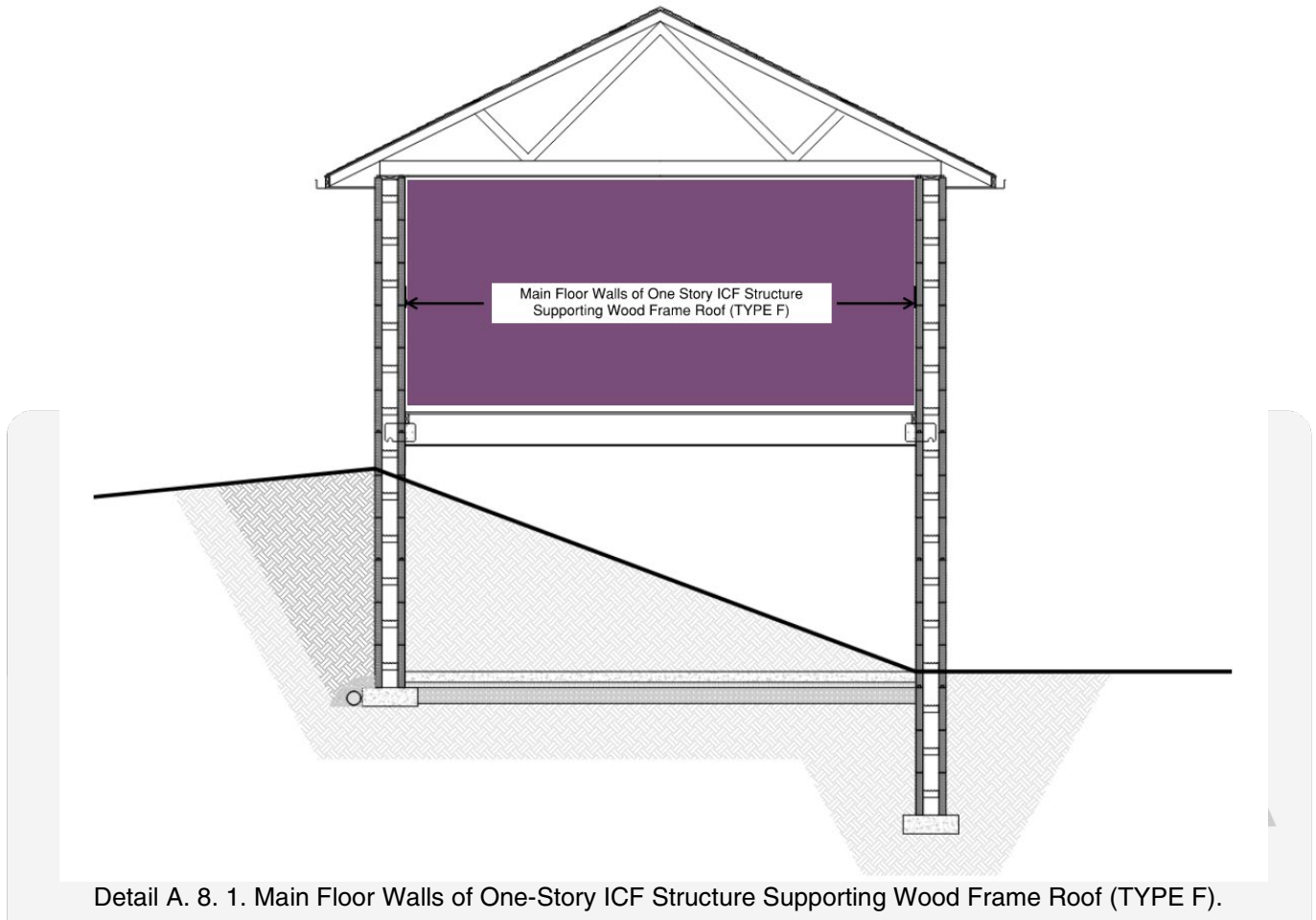

**INSULATING CONCRETE FORMS**  
MANUFACTURERS ASSOCIATION

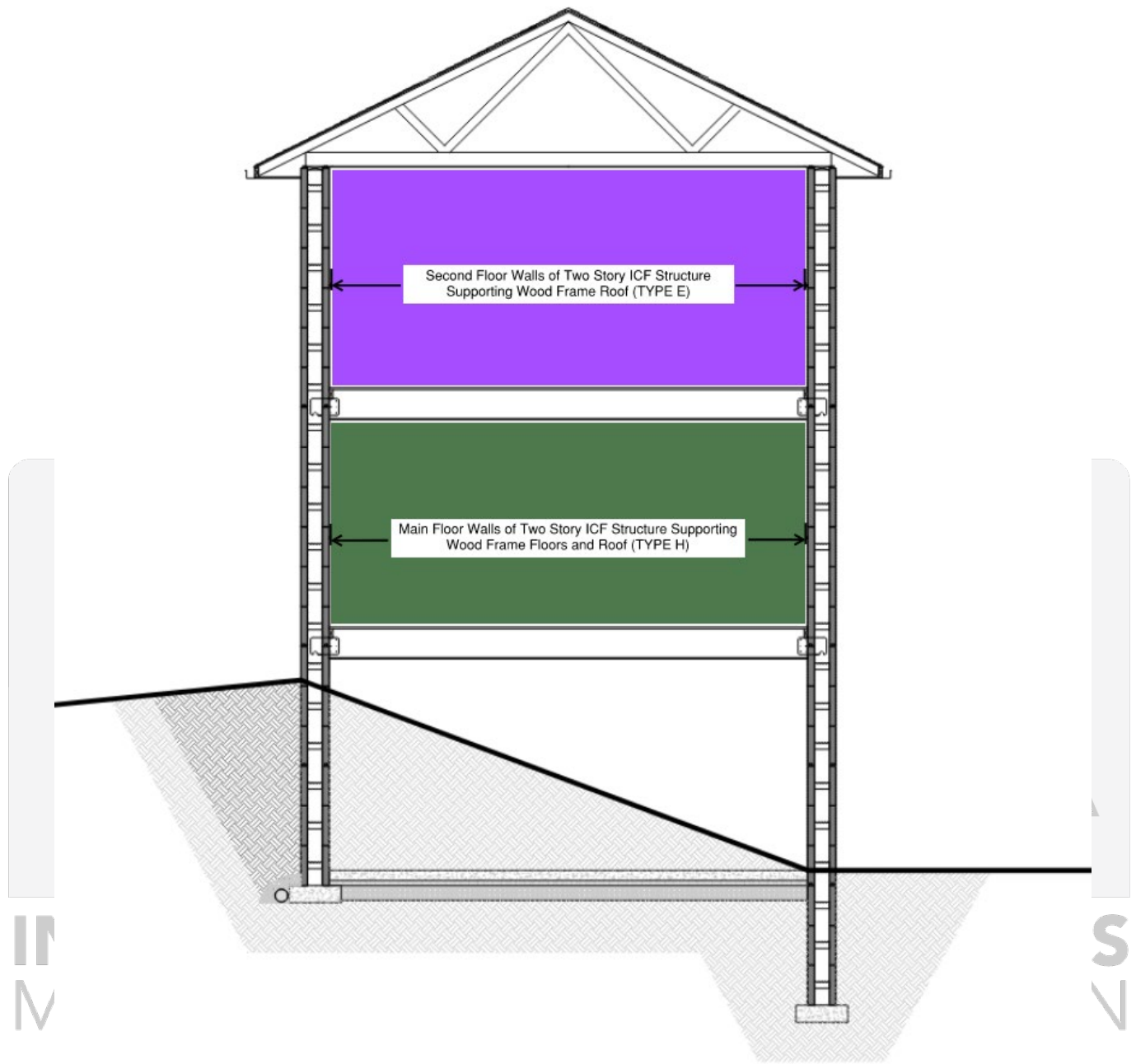

Detail A. 8. 2. Second Floor Walls of a Two-Story ICF Structure Supporting Wood Frame Roof & Main Floor Walls of a Two-Story ICF Structure Supporting Wood Frame Floors and Roof (TYPE E & H).



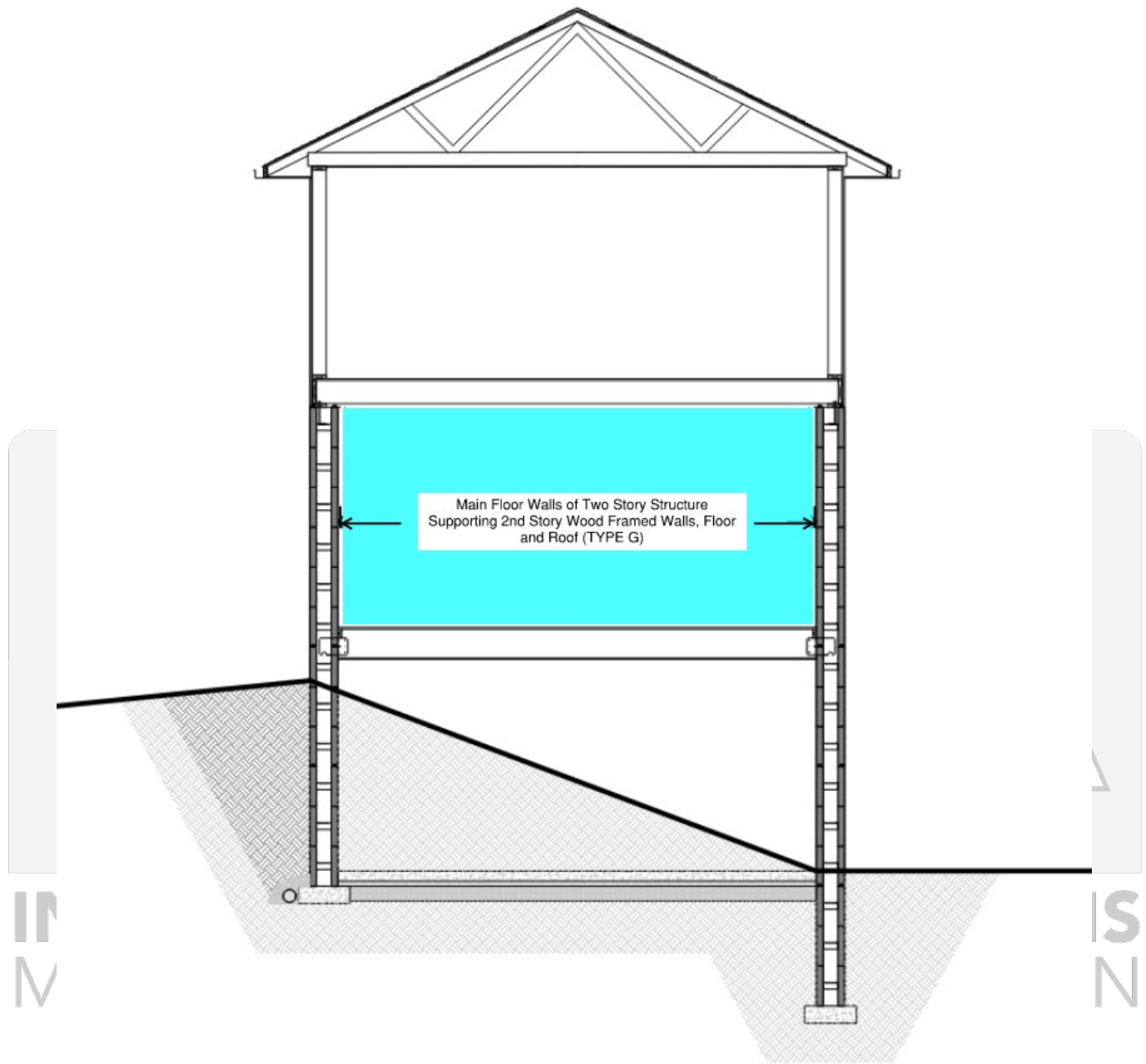

Detail A. 8. 3. Main Floor Walls of a Two-Story Structure Supporting 2<sup>nd</sup> Story Wood Frame Walls, Floor and Roof (TYPE G).

## Detail A. 9. Walkout Basement Wall Configurations

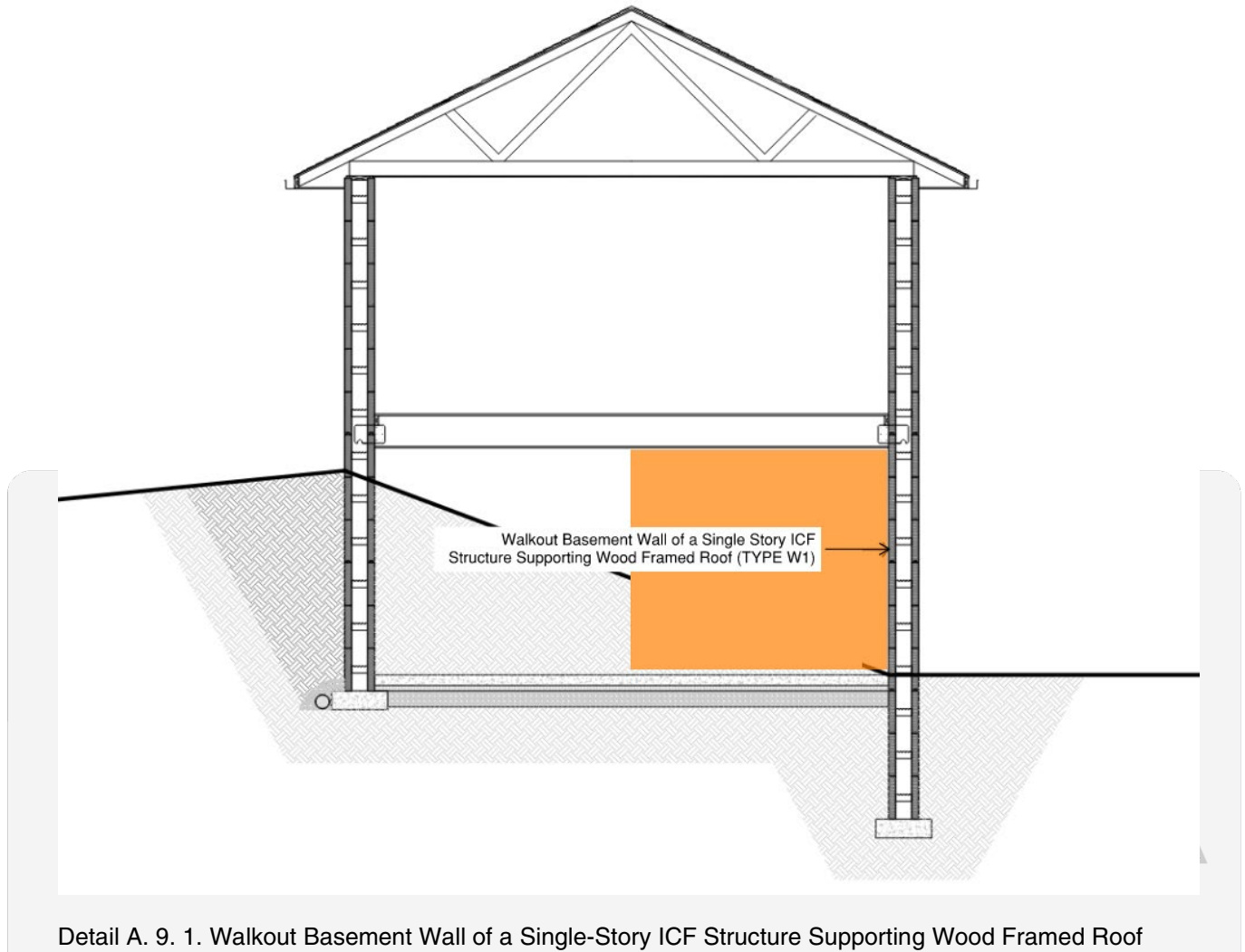

Detail A. 9. 1. Walkout Basement Wall of a Single-Story ICF Structure Supporting Wood Framed Roof (TYPE W1).

INSULATING CONCRETE FORMS  
MANUFACTURERS ASSOCIATION

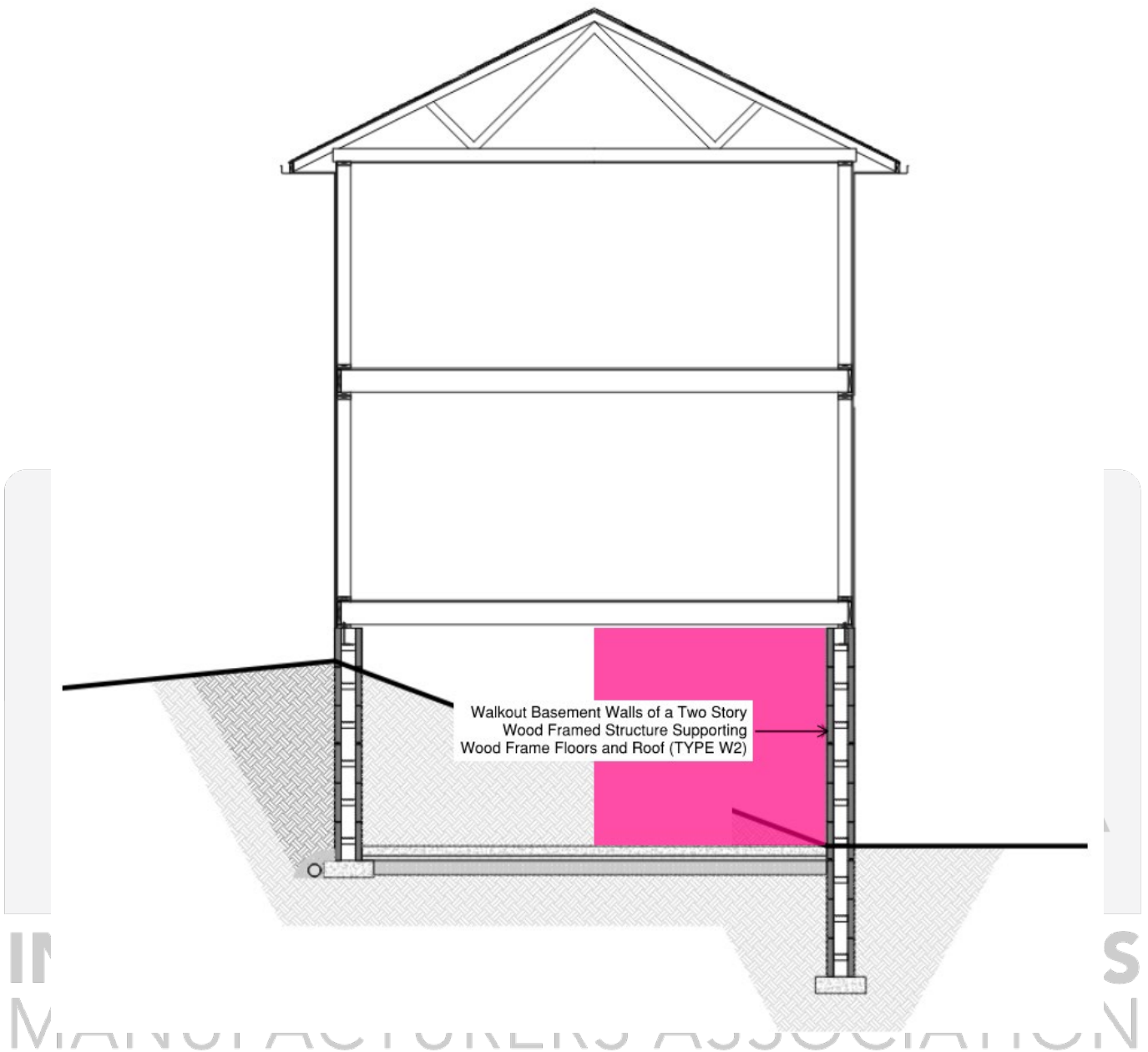

Detail A. 9. 2. Walkout Basement Wall of a Two-Story Wood Framed Structure Supporting Wood Frame Floors and Roof (TYPE W2).

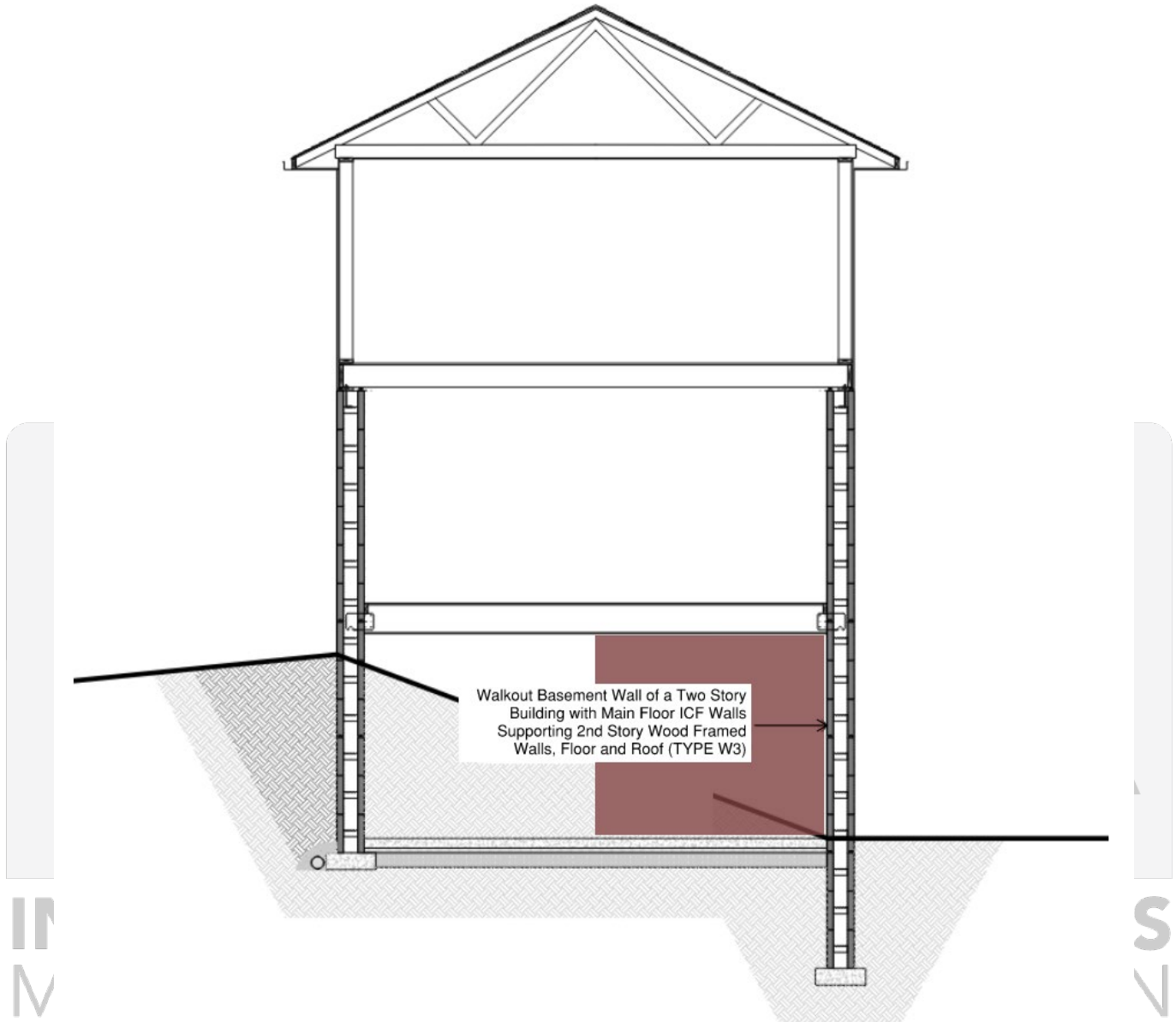

Detail A. 9. 3. Walkout Basement Wall of a Two-Story Building with Main Floor ICF Walls Supporting Second Story Wood Framed Walls, Floor and Roof (TYPE W3).

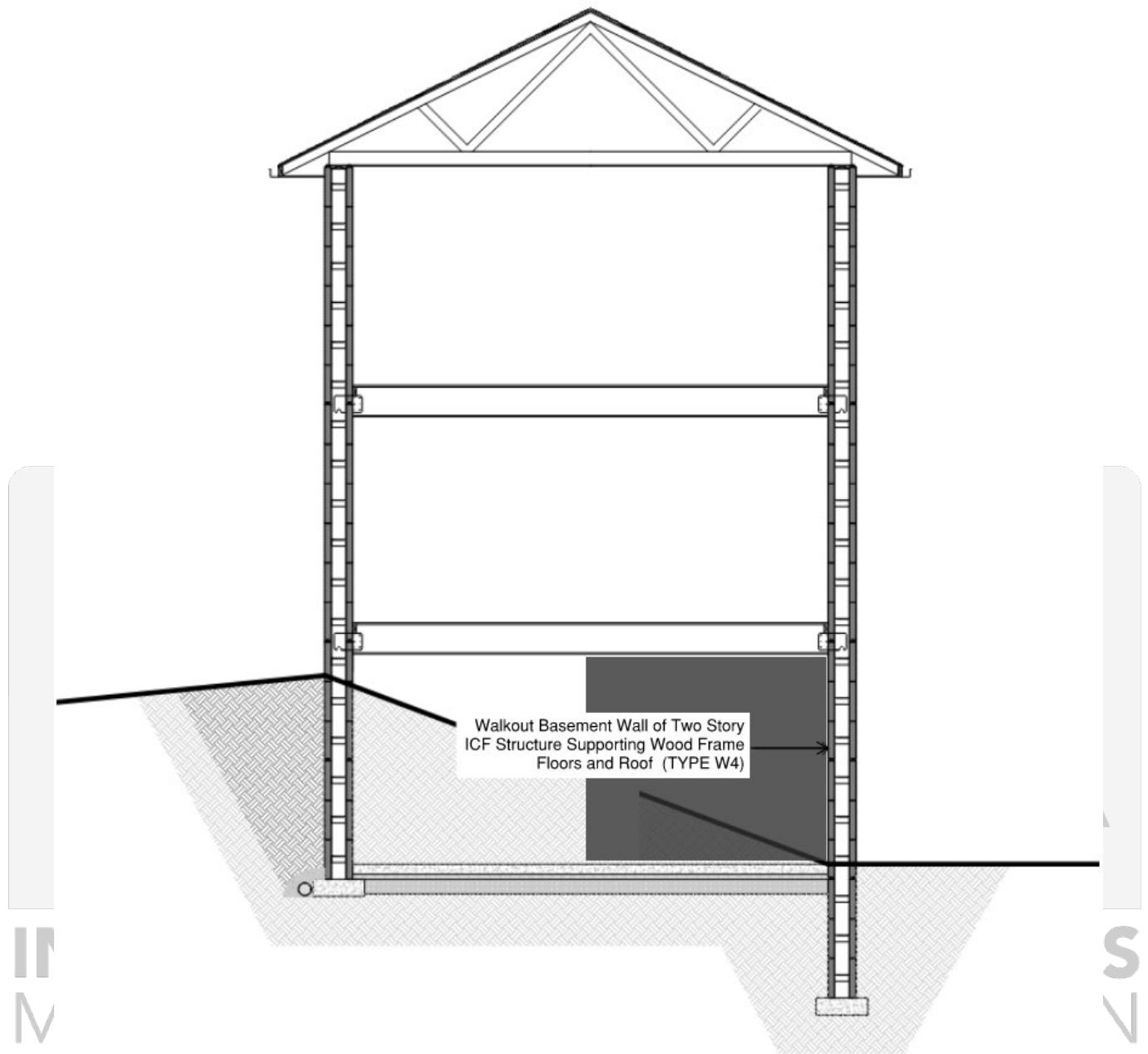

Detail A. 9. 4. Walkout Basement Wall of a Two-Story ICF Structure Supporting Wood Frame Floors, and Roof (TYPE W4).

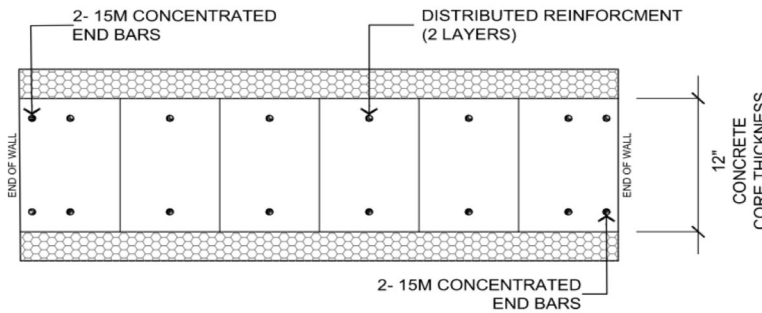
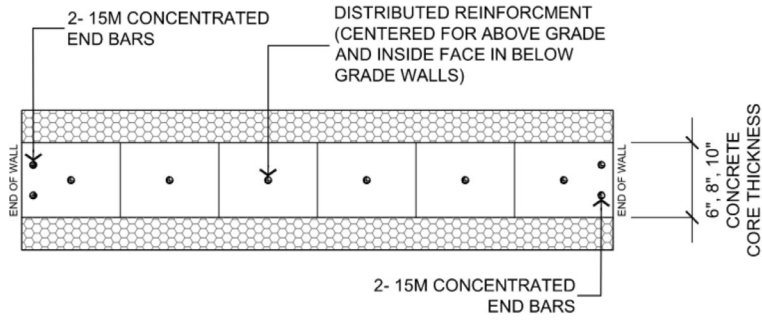

**REBAR PLACEMENT NOTES:**

1. PROVIDE 1-1/2" (40mm) COVER TO REINFORCING BARS, TYPICAL.
2. PROVIDE 1-1/2" (40mm) CLEAR SPACING BETWEEN BARS, TYPICAL.
3. PLACE CONCENTRATED BARS AS CLOSE TO THE SIDES OF THE WALL AS MINIMUM COVER PERMITS.

**Detail A. 10. Shear Wall Distributed and Concentrated Vertical Reinforcing Placement.**

# INSULATING CONCRETE FORMS MANUFACTURERS ASSOCIATION

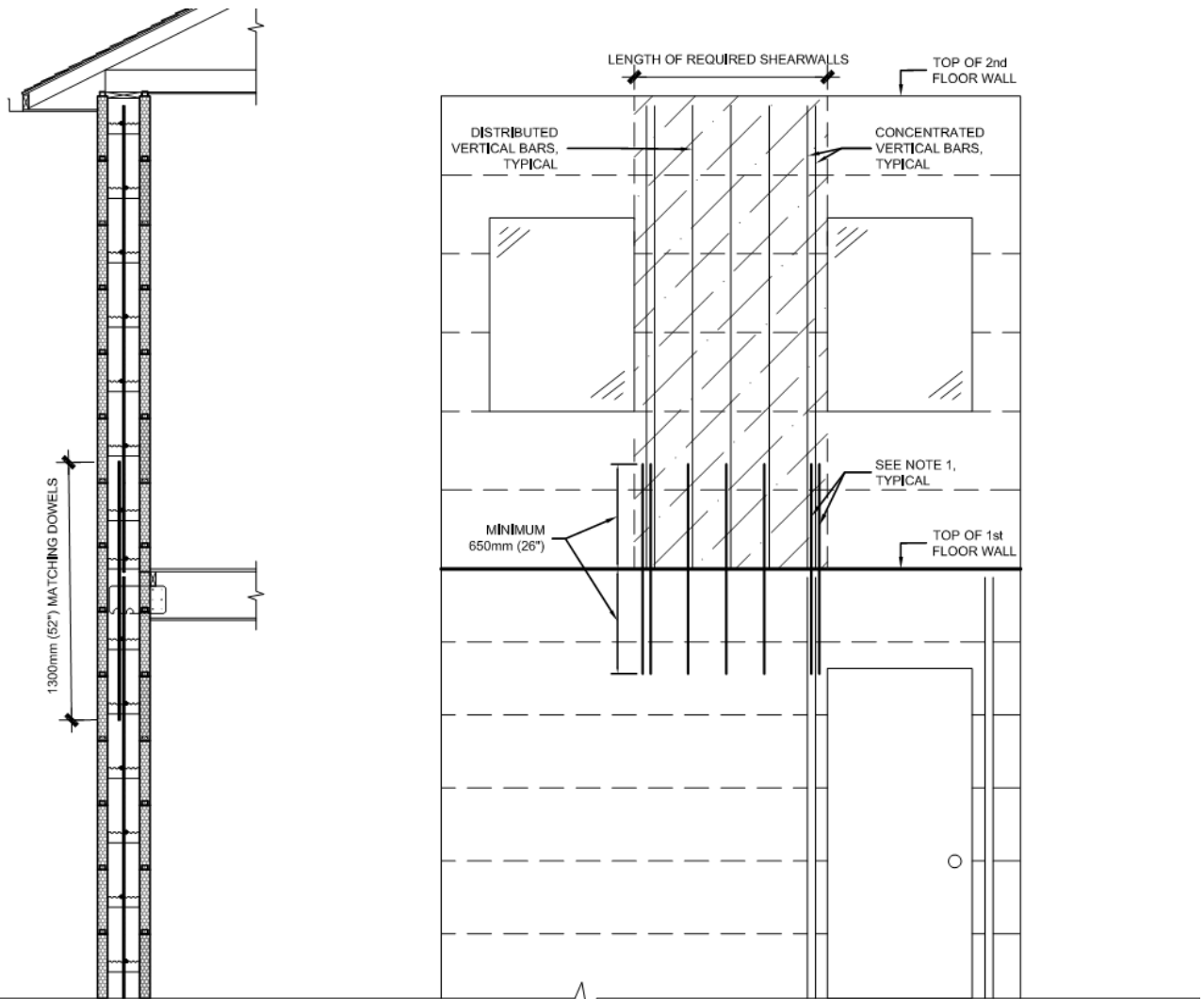

NOTES

1. PROVIDE 1300mm (52") LONG MATCHING DOWELS INTO WALL BELOW WALL. DOWELS INSTALLED PRIOR TO CONSTRUCTING FLOOR ABOVE

**Detail A. 11. Shear Wall Dowels.**

INSULATING CONCRETE FORMS  
MANUFACTURERS ASSOCIATION

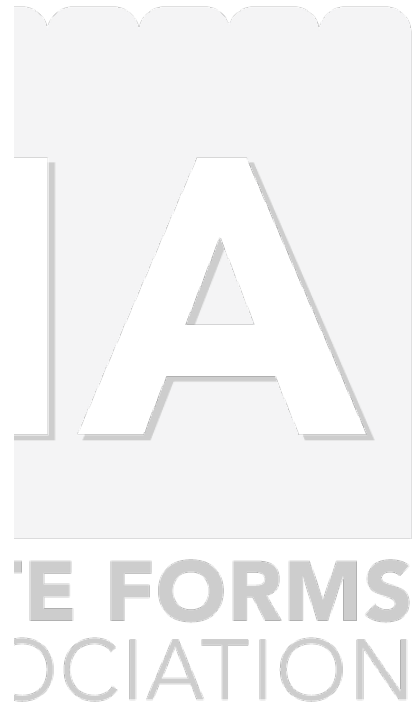
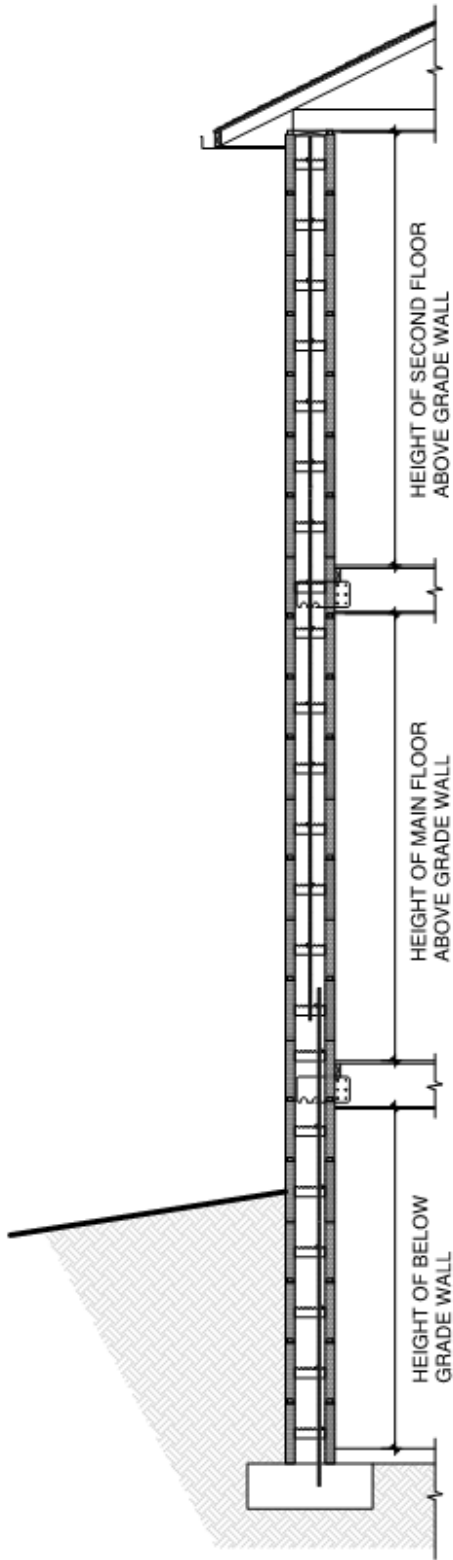

**Detail A. 12. Above and Below Grade Wall Height.**



**Table B.1.1.– Below Grade Wall Distributed Reinforcement for Seismic Zone Classification,  $S_{a,ICF} \leq 0.11$  and Hourly Wind Pressure,  $q_{1/50} \leq 1.05kPa$ , for ICF Walls with 6" Tie Spacing**

Wall Height m (ft)	Backfill Height m (ft)	Vertical Steel (Size and Spacing)							
		Backfill Equivalent Fluid Density							
		480 kg/m <sup>3</sup> (30 pcf)				720 kg/m <sup>3</sup> (45 pcf)			
		150 mm (6") Wall	200 mm (8") Wall	250 mm (10") Wall	300 mm (12") Wall	150 mm (6") Wall	200 mm (8") Wall	250 mm (10") Wall	300 mm (12") Wall
2.44 (8.0)	1.22 (4.0)	10 M @ 450 (18)	10 M @ 750 (30)	10 M @ 900 (36)	10 M @ 900 (36)	10 M @ 30 (1)	10 M @ 600 (24)	10 M @ 900 (36)	10 M @ 900 (36)
	1.53 (5.0)	15 M @ 600 (24)	10 M @ 600 (24)	10 M @ 750 (30)	10 M @ 900 (36)	15 M @ 600 (24)	10 M @ 450 (18)	10 M @ 750 (30)	10 M @ 900 (36)
	1.83 (6.0)	15 M @ 600 (24)	10 M @ 450 (18)	10 M @ 750 (30)	10 M @ 900 (36)	15 M @ 450 (18)	15 M @ 750 (30)	10 M @ 600 (24)	10 M @ 750 (30)
	2.13 (7.0)	15 M @ 450 (18)	15 M @ 750 (30)	10 M @ 600 (24)	10 M @ 600 (24)	15 M @ 450 (18)	15 M @ 600 (24)	10 M @ 450 (18)	10 M @ 600 (24)
	2.44 (8.0)	15 M @ 450 (18)	15 M @ 600 (24)	10 M @ 450 (18)	10 M @ 450 (18)	15 M @ 300 (12)	15 M @ 450 (18)	15 M @ 600 (24)	15 M @ 900 (36)
2.74 (9.0)	1.22 (4.0)	15 M @ 750 (30)	10 M @ 600 (24)	10 M @ 900 (36)	10 M @ 900 (36)	15 M @ 750 (30)	10 M @ 600 (24)	10 M @ 750 (30)	10 M @ 900 (36)
	1.53 (5.0)	15 M @ 750 (30)	10 M @ 450 (18)	10 M @ 750 (30)	10 M @ 900 (36)	15 M @ 600 (24)	10 M @ 450 (18)	10 M @ 600 (24)	10 M @ 900 (36)
	1.83 (6.0)	15 M @ 600 (24)	15 M @ 900 (36)	10 M @ 600 (24)	10 M @ 750 (30)	15 M @ 450 (18)	15 M @ 750 (30)	10 M @ 450 (18)	10 M @ 600 (24)
	2.13 (7.0)	15 M @ 450 (18)	15 M @ 750 (30)	10 M @ 450 (18)	10 M @ 600 (24)	15 M @ 450 (18)	15 M @ 450 (18)	15 M @ 750 (30)	15 M @ 900 (36)
	2.44 (8.0)	15 M @ 300 (12)	15 M @ 600 (24)	15 M @ 750 (30)	15 M @ 900 (36)	15 M @ 300 (12)	15 M @ 450 (18)	15 M @ 600 (24)	15 M @ 600 (24)
	2.74 (9.0)	15 M @ 300 (12)	15 M @ 450 (18)	15 M @ 600 (24)	15 M @ 750 (30)	15 M @ 150 (6)	15 M @ 450 (18)	15 M @ 450 (18)	15 M @ 450 (18)
3.05 (10.0)	1.22 (4.0)	15 M @ 750 (30)	10 M @ 600 (24)	10 M @ 900 (36)	10 M @ 900 (36)	15 M @ 750 (30)	10 M @ 450 (18)	10 M @ 750 (30)	10 M @ 900 (36)
	1.53 (5.0)	15 M @ 600 (24)	15 M @ 900 (36)	10 M @ 600 (24)	10 M @ 900 (36)	15 M @ 600 (24)	15 M @ 750 (30)	10 M @ 600 (24)	10 M @ 750 (30)
	1.83 (6.0)	15 M @ 450 (18)	15 M @ 750 (30)	10 M @ 600 (24)	10 M @ 750 (30)	15 M @ 450 (18)	15 M @ 600 (24)	10 M @ 450 (18)	10 M @ 450 (18)
	2.13 (7.0)	15 M @ 450 (18)	15 M @ 600 (24)	10 M @ 450 (18)	10 M @ 600 (24)	15 M @ 300 (12)	15 M @ 450 (18)	15 M @ 600 (24)	15 M @ 750 (30)
	2.44 (8.0)	15 M @ 300 (12)	15 M @ 450 (18)	15 M @ 750 (30)	15 M @ 900 (36)	15 M @ 300 (12)	15 M @ 450 (18)	15 M @ 450 (18)	15 M @ 600 (24)
	2.74 (9.0)	15 M @ 150 (6)	15 M @ 450 (18)	15 M @ 600 (24)	15 M @ 750 (30)	15 M @ 150 (6)	15 M @ 300 (12)	15 M @ 450 (18)	15 M @ 450 (18)
	3.05 (10.0)	15 M @ 150 (6)	15 M @ 300 (12)	15 M @ 450 (18)	15 M @ 600 (24)	15 M @ 150 (6)	15 M @ 300 (12)	15 M @ 450 (18)	15 M @ 300 (12)
3.35 (11.0)	1.22 (4.0)	15 M @ 600 (24)	10 M @ 450 (18)	10 M @ 750 (30)	10 M @ 900 (36)	15 M @ 600 (24)	10 M @ 450 (18)	10 M @ 600 (24)	10 M @ 900 (36)
	1.53 (5.0)	15 M @ 600 (24)	15 M @ 900 (36)	10 M @ 600 (24)	10 M @ 750 (30)	15 M @ 450 (18)	15 M @ 750 (30)	10 M @ 450 (18)	10 M @ 600 (24)
	1.83 (6.0)	15 M @ 450 (18)	15 M @ 750 (30)	10 M @ 450 (18)	10 M @ 600 (24)	15 M @ 450 (18)	15 M @ 600 (24)	10 M @ 450 (18)	10 M @ 450 (18)
	2.13 (7.0)	15 M @ 300 (12)	15 M @ 600 (24)	15 M @ 750 (30)	15 M @ 900 (36)	15 M @ 300 (12)	15 M @ 450 (18)	15 M @ 600 (24)	15 M @ 750 (30)
	2.44 (8.0)	15 M @ 300 (12)	15 M @ 450 (18)	15 M @ 600 (24)	15 M @ 750 (30)	15 M @ 150 (6)	15 M @ 450 (18)	15 M @ 450 (18)	15 M @ 600 (24)
	2.74 (9.0)	15 M @ 150 (6)	15 M @ 300 (12)	15 M @ 450 (18)	15 M @ 600 (24)	15 M @ 150 (6)	15 M @ 300 (12)	15 M @ 450 (18)	15 M @ 450 (18)
	3.05 (10.0)	15 M @ 150 (6)	15 M @ 300 (12)	15 M @ 450 (18)	15 M @ 450 (18)	15 M @ 150 (6)	15 M @ 150 (6)	15 M @ 300 (12)	15 M @ 300 (12)
	3.35 (11.0)		15 M @ 300 (12)	15 M @ 300 (12)	15 M @ 450 (18)		15 M @ 150 (6)	15 M @ 300 (12)	15 M @ 300 (12)
3.66 (12.0)	1.22 (4.0)	15 M @ 600 (24)	10 M @ 450 (18)	10 M @ 750 (30)	10 M @ 900 (36)	15 M @ 600 (24)	15 M @ 750 (30)	10 M @ 600 (24)	10 M @ 900 (36)
	1.53 (5.0)	15 M @ 600 (24)	15 M @ 750 (30)	10 M @ 450 (18)	10 M @ 750 (30)	15 M @ 450 (18)	15 M @ 600 (24)	10 M @ 450 (18)	10 M @ 600 (24)
	1.83 (6.0)	15 M @ 450 (18)	15 M @ 600 (24)	10 M @ 450 (18)	10 M @ 600 (24)	15 M @ 300 (12)	15 M @ 600 (24)	15 M @ 750 (30)	15 M @ 900 (36)
	2.13 (7.0)	15 M @ 300 (12)	15 M @ 600 (24)	15 M @ 750 (30)	15 M @ 900 (36)	15 M @ 300 (12)	15 M @ 450 (18)	15 M @ 600 (24)	15 M @ 750 (30)
	2.44 (8.0)	15 M @ 150 (6)	15 M @ 450 (18)	15 M @ 600 (24)	15 M @ 750 (30)	15 M @ 150 (6)	15 M @ 300 (12)	15 M @ 450 (18)	15 M @ 450 (18)
	2.74 (9.0)	15 M @ 150 (6)	15 M @ 300 (12)	15 M @ 450 (18)	15 M @ 600 (24)	15 M @ 150 (6)	15 M @ 300 (12)	15 M @ 450 (18)	15 M @ 450 (18)
	3.05 (10.0)	15 M @ 150 (6)	15 M @ 300 (12)	15 M @ 300 (12)	15 M @ 450 (18)	15 M @ 150 (6)	15 M @ 150 (6)	15 M @ 300 (12)	15 M @ 300 (12)
	3.35 (11.0)		15 M @ 150 (6)	15 M @ 300 (12)	15 M @ 300 (12)		15 M @ 150 (6)	15 M @ 300 (12)	15 M @ 300 (12)
Horizontal Reinforcement	Block Height of 12" and 18"	10 M @ 900 (36)	10 M @ 900 (36)	10 M @ 900 (36)	10 M @ 900 (36)	10 M @ 900 (36)	10 M @ 900 (36)	10 M @ 900 (36)	10 M @ 900 (36)
	Block Height of 16"	10 M @ 800 (32)	10 M @ 800 (32)	10 M @ 800 (32)	10 M @ 800 (32)	10 M @ 800 (32)	10 M @ 800 (32)	10 M @ 800 (32)	10 M @ 800 (32)

**NOTES:**

- For highlighted data, where the below grade wall meets all the requirements of NBCC Part 9 for a solid concrete foundation wall and supports only wood frame construction above, a 20MPa unreinforced wall is adequate as per 2020 NBCC table 9.15.4.2.A. Provide the reinforcing shown for walls supporting ICF walls above or with brick veneer supported with the brick ledge form.
- Below grade walls supporting "Drained Earth" in accordance with 2020 NBCC 9.4.4.6 may be designed for an equivalent fluid pressure of 480 kg/m<sup>3</sup>.
- This table is to be used in conjunction with the "Design Limitations" and "Below Grade Reinforcement Placement" drawing.

INSULATING CONCRETE FORMS  
MANUFACTURERS ASSOCIATION

**Table B.1.1. Continued – Below Grade Wall Distributed Reinforcement for Seismic Zone Classification,  $S_{a,ICF} \leq 0.11$  and Hourly Wind Pressure,  $q_{1/50} \leq 1.05\text{kPa}$ , for ICF Walls with 6" Tie Spacing**

Wall Height m (ft)	Backfill Height m (ft)	Vertical Steel (Size and Spacing)							
		Backfill Equivalent Fluid Density							
		960 kg/m <sup>3</sup> (60 pcf)				1200 kg/m <sup>3</sup> (75 pcf)			
		150 mm (6") Wall	200 mm (8") Wall	250 mm (10") Wall	300 mm (12") Wall	150 mm (6") Wall	200 mm (8") Wall	250 mm (10") Wall	300 mm (12") Wall
2.44 (8.0)	1.22 (4.0)	15 M @ 600 (24)	10 M @ 450 (18)	10 M @ 750 (30)	10 M @ 900 (36)	15 M @ 600 (24)	10 M @ 450 (18)	10 M @ 750 (30)	10 M @ 900 (36)
	1.53 (5.0)	15 M @ 600 (24)	10 M @ 450 (18)	10 M @ 600 (24)	10 M @ 900 (36)	15 M @ 450 (18)	15 M @ 750 (30)	15 M @ 900 (36)	10 M @ 750 (30)
	1.83 (6.0)	15 M @ 450 (18)	15 M @ 600 (24)	10 M @ 450 (18)	10 M @ 600 (24)	15 M @ 450 (18)	15 M @ 450 (18)	15 M @ 750 (30)	15 M @ 900 (36)
	2.13 (7.0)	15 M @ 300 (12)	15 M @ 450 (18)	15 M @ 600 (24)	15 M @ 900 (36)	15 M @ 300 (12)	15 M @ 450 (18)	15 M @ 450 (18)	15 M @ 750 (30)
	2.44 (8.0)	15 M @ 300 (12)	15 M @ 450 (18)	15 M @ 450 (18)	15 M @ 750 (30)	15 M @ 150 (6)	15 M @ 300 (12)	15 M @ 450 (18)	15 M @ 450 (18)
2.74 (9.0)	1.22 (4.0)	15 M @ 600 (24)	10 M @ 450 (18)	10 M @ 600 (24)	10 M @ 900 (36)	15 M @ 600 (24)	15 M @ 900 (36)	10 M @ 450 (18)	10 M @ 750 (30)
	1.53 (5.0)	15 M @ 450 (18)	15 M @ 600 (24)	15 M @ 750 (30)	10 M @ 750 (30)	15 M @ 450 (18)	15 M @ 600 (24)	15 M @ 900 (36)	10 M @ 600 (24)
	1.83 (6.0)	15 M @ 450 (18)	15 M @ 450 (18)	15 M @ 750 (30)	10 M @ 600 (24)	15 M @ 300 (12)	15 M @ 450 (18)	15 M @ 600 (24)	15 M @ 900 (36)
	2.13 (7.0)	15 M @ 300 (12)	15 M @ 450 (18)	15 M @ 600 (24)	15 M @ 900 (36)	15 M @ 300 (12)	15 M @ 450 (18)	15 M @ 450 (18)	15 M @ 600 (24)
	2.44 (8.0)	15 M @ 150 (6)	15 M @ 300 (12)	15 M @ 450 (18)	15 M @ 450 (18)	15 M @ 150 (6)	15 M @ 300 (12)	15 M @ 450 (18)	15 M @ 450 (18)
3.05 (10.0)	1.22 (4.0)	15 M @ 600 (24)	10 M @ 450 (18)	10 M @ 600 (24)	10 M @ 900 (36)	15 M @ 600 (24)	15 M @ 750 (30)	10 M @ 450 (18)	10 M @ 750 (30)
	1.53 (5.0)	15 M @ 450 (18)	15 M @ 600 (24)	10 M @ 450 (18)	10 M @ 600 (24)	15 M @ 450 (18)	15 M @ 600 (24)	15 M @ 900 (36)	10 M @ 450 (18)
	1.83 (6.0)	15 M @ 450 (18)	15 M @ 450 (18)	15 M @ 750 (30)	10 M @ 900 (36)	15 M @ 300 (12)	15 M @ 450 (18)	15 M @ 600 (24)	15 M @ 750 (30)
	2.13 (7.0)	15 M @ 300 (12)	15 M @ 450 (18)	15 M @ 450 (18)	15 M @ 600 (24)	15 M @ 150 (6)	15 M @ 300 (12)	15 M @ 450 (18)	15 M @ 450 (18)
	2.44 (8.0)	15 M @ 150 (6)	15 M @ 300 (12)	15 M @ 450 (18)	15 M @ 450 (18)	15 M @ 150 (6)	15 M @ 300 (12)	15 M @ 300 (12)	15 M @ 300 (12)
3.35 (11.0)	1.22 (4.0)	15 M @ 600 (24)	15 M @ 600 (24)	10 M @ 600 (24)	10 M @ 750 (30)	15 M @ 600 (24)	15 M @ 750 (30)	15 M @ 900 (36)	10 M @ 750 (30)
	1.53 (5.0)	15 M @ 450 (18)	15 M @ 600 (24)	15 M @ 900 (36)	10 M @ 450 (18)	15 M @ 600 (24)	15 M @ 600 (24)	15 M @ 750 (30)	10 M @ 450 (18)
	1.83 (6.0)	15 M @ 450 (18)	15 M @ 450 (18)	15 M @ 600 (24)	15 M @ 750 (30)	15 M @ 300 (12)	15 M @ 450 (18)	15 M @ 600 (24)	15 M @ 600 (24)
	2.13 (7.0)	15 M @ 300 (12)	15 M @ 450 (18)	15 M @ 450 (18)	15 M @ 600 (24)	15 M @ 150 (6)	15 M @ 300 (12)	15 M @ 450 (18)	15 M @ 450 (18)
	2.44 (8.0)	15 M @ 150 (6)	15 M @ 300 (12)	15 M @ 450 (18)	15 M @ 450 (18)	15 M @ 150 (6)	15 M @ 300 (12)	15 M @ 300 (12)	15 M @ 300 (12)
3.66 (12.0)	1.22 (4.0)	15 M @ 600 (24)	15 M @ 600 (24)	10 M @ 450 (18)	10 M @ 750 (30)	15 M @ 450 (18)	15 M @ 750 (30)	15 M @ 900 (36)	10 M @ 600 (24)
	1.53 (5.0)	15 M @ 450 (18)	15 M @ 450 (18)	15 M @ 750 (30)	10 M @ 450 (18)	15 M @ 450 (18)	15 M @ 450 (18)	15 M @ 750 (30)	15 M @ 900 (36)
	1.83 (6.0)	15 M @ 300 (12)	15 M @ 450 (18)	15 M @ 600 (24)	15 M @ 750 (30)	15 M @ 300 (12)	15 M @ 450 (18)	15 M @ 450 (18)	15 M @ 600 (24)
	2.13 (7.0)	15 M @ 150 (6)	15 M @ 300 (12)	15 M @ 450 (18)	15 M @ 450 (18)	15 M @ 150 (6)	15 M @ 300 (12)	15 M @ 450 (18)	15 M @ 450 (18)
	2.44 (8.0)	15 M @ 150 (6)	15 M @ 300 (12)	15 M @ 450 (18)	15 M @ 300 (12)	15 M @ 150 (6)	15 M @ 300 (12)	15 M @ 300 (12)	15 M @ 300 (12)
Horizontal Reinforcement	Block Height of 12" and 18"	10 M @ 900 (36)	10 M @ 900 (36)	10 M @ 900 (36)	10 M @ 900 (36)	10 M @ 900 (36)	10 M @ 900 (36)	10 M @ 900 (36)	10 M @ 900 (36)
	Block Height of 16"	10 M @ 800 (32)	10 M @ 800 (32)	10 M @ 800 (32)	10 M @ 800 (32)	10 M @ 800 (32)	10 M @ 800 (32)	10 M @ 800 (32)	10 M @ 800 (32)

**NOTES:**

- For highlighted data, where the below grade wall meets all the requirements of NBCC Part 9 for a solid concrete foundation wall and supports only wood frame construction above, a 20MPa unreinforced wall is adequate as per 2020 NBCC table 9.15.4.2.A. Provide the reinforcing shown for walls supporting ICF walls above or with brick veneer supported with the brick ledge form.
- Below grade walls supporting "Drained Earth" in accordance with 2020 NBCC 9.4.4.6 may be designed for an equivalent fluid pressure of 480 kg/m<sup>3</sup>.
- This table is to be used in conjunction with the "Design Limitations" and "Below Grade Reinforcement Placement" drawing.

INSULATING CONCRETE FORMS  
MANUFACTURERS ASSOCIATION

**Table B.1.2.– Below Grade Wall Distributed Reinforcement for Seismic Zone Classification,  $S_{a,ICF} \leq 0.11$  and Hourly Wind Pressure,  $q_{1/50} \leq 1.05kPa$ , for ICF Walls with 8" Tie Spacing**

Wall Height m (ft)	Backfill Height m (ft)	Vertical Steel (Size and Spacing)							
		Backfill Equivalent Fluid Density							
		480 kg/m <sup>3</sup> (30 pcf)				720 kg/m <sup>3</sup> (45 pcf)			
		150 mm (6") Wall	200 mm (8") Wall	250 mm (10") Wall	300 mm (12") Wall	150 mm (6") Wall	200 mm (8") Wall	250 mm (10") Wall	300 mm (12") Wall
2.44 (8.0)	1.22 (4.0)	10 M @ 400 (16)	10 M @ 600 (24)	10 M @ 800 (32)	10 M @ 800 (32)	10 M @ 400 (16)	10 M @ 600 (24)	10 M @ 800 (32)	10 M @ 800 (32)
	1.53 (5.0)	10 M @ 400 (16)	10 M @ 600 (24)	10 M @ 800 (32)	10 M @ 800 (32)	15 M @ 600 (24)	10 M @ 400 (16)	10 M @ 800 (32)	10 M @ 800 (32)
	1.83 (6.0)	15 M @ 600 (24)	10 M @ 400 (16)	10 M @ 600 (24)	10 M @ 800 (32)	15 M @ 400 (16)	15 M @ 600 (24)	10 M @ 600 (24)	10 M @ 800 (32)
	2.13 (7.0)	15 M @ 400 (16)	15 M @ 600 (24)	10 M @ 600 (24)	10 M @ 600 (24)	15 M @ 400 (16)	15 M @ 600 (24)	10 M @ 400 (16)	10 M @ 600 (24)
	2.44 (8.0)	15 M @ 400 (16)	15 M @ 600 (24)	10 M @ 400 (16)	10 M @ 600 (24)	15 M @ 400 (16)	15 M @ 400 (16)	15 M @ 600 (24)	15 M @ 800 (32)
2.74 (9.0)	1.22 (4.0)	15 M @ 800 (32)	10 M @ 600 (24)	10 M @ 800 (32)	10 M @ 800 (32)	15 M @ 800 (32)	10 M @ 600 (24)	10 M @ 800 (32)	10 M @ 800 (32)
	1.53 (5.0)	15 M @ 800 (32)	10 M @ 400 (16)	10 M @ 800 (32)	10 M @ 800 (32)	15 M @ 600 (24)	10 M @ 400 (16)	10 M @ 600 (24)	10 M @ 800 (32)
	1.83 (6.0)	15 M @ 600 (24)	15 M @ 800 (32)	10 M @ 600 (24)	10 M @ 800 (32)	15 M @ 400 (16)	15 M @ 600 (24)	10 M @ 400 (16)	10 M @ 600 (24)
	2.13 (7.0)	15 M @ 400 (16)	15 M @ 600 (24)	10 M @ 400 (16)	10 M @ 600 (24)	15 M @ 400 (16)	15 M @ 400 (16)	15 M @ 600 (24)	15 M @ 800 (32)
	2.44 (8.0)	15 M @ 400 (16)	15 M @ 600 (24)	15 M @ 800 (32)	15 M @ 800 (32)	15 M @ 200 (8)	15 M @ 400 (16)	15 M @ 600 (24)	15 M @ 800 (32)
2.74 (9.0)	15 M @ 200 (8)	15 M @ 400 (16)	15 M @ 600 (24)	15 M @ 800 (32)	15 M @ 200 (8)	15 M @ 400 (16)	15 M @ 400 (16)	15 M @ 400 (16)	
3.05 (10.0)	1.22 (4.0)	15 M @ 600 (24)	10 M @ 600 (24)	10 M @ 800 (32)	10 M @ 800 (32)	15 M @ 600 (24)	10 M @ 400 (16)	10 M @ 600 (24)	10 M @ 800 (32)
	1.53 (5.0)	15 M @ 600 (24)	15 M @ 800 (32)	10 M @ 600 (24)	10 M @ 800 (32)	15 M @ 600 (24)	15 M @ 800 (32)	10 M @ 600 (24)	10 M @ 600 (24)
	1.83 (6.0)	15 M @ 400 (16)	15 M @ 600 (24)	10 M @ 600 (24)	10 M @ 600 (24)	15 M @ 400 (16)	15 M @ 600 (24)	10 M @ 400 (16)	10 M @ 400 (16)
	2.13 (7.0)	15 M @ 400 (16)	15 M @ 600 (24)	10 M @ 400 (16)	10 M @ 600 (24)	15 M @ 400 (16)	15 M @ 400 (16)	15 M @ 600 (24)	15 M @ 800 (32)
	2.44 (8.0)	15 M @ 400 (16)	15 M @ 400 (16)	15 M @ 600 (24)	15 M @ 800 (32)	15 M @ 200 (8)	15 M @ 400 (16)	15 M @ 400 (16)	15 M @ 600 (24)
2.74 (9.0)	15 M @ 200 (8)	15 M @ 400 (16)	15 M @ 600 (24)	15 M @ 600 (24)	15 M @ 200 (8)	15 M @ 400 (16)	15 M @ 400 (16)	15 M @ 400 (16)	
3.05 (10.0)	15 M @ 200 (8)	15 M @ 400 (16)	15 M @ 400 (16)	15 M @ 600 (24)	15 M @ 200 (8)	15 M @ 200 (8)	15 M @ 400 (16)	15 M @ 400 (16)	
3.35 (11.0)	1.22 (4.0)	15 M @ 600 (24)	10 M @ 400 (16)	10 M @ 800 (32)	10 M @ 800 (32)	15 M @ 600 (24)	10 M @ 400 (16)	10 M @ 600 (24)	10 M @ 800 (32)
	1.53 (5.0)	15 M @ 600 (24)	15 M @ 800 (32)	10 M @ 600 (24)	10 M @ 800 (32)	15 M @ 400 (16)	15 M @ 600 (24)	10 M @ 400 (16)	10 M @ 600 (24)
	1.83 (6.0)	15 M @ 400 (16)	15 M @ 600 (24)	10 M @ 400 (16)	10 M @ 600 (24)	15 M @ 400 (16)	15 M @ 600 (24)	10 M @ 400 (16)	10 M @ 400 (16)
	2.13 (7.0)	15 M @ 400 (16)	15 M @ 600 (24)	15 M @ 600 (24)	15 M @ 800 (32)	15 M @ 400 (16)	15 M @ 400 (16)	15 M @ 600 (24)	15 M @ 800 (32)
	2.44 (8.0)	15 M @ 200 (8)	15 M @ 400 (16)	15 M @ 600 (24)	15 M @ 800 (32)	15 M @ 200 (8)	15 M @ 400 (16)	15 M @ 400 (16)	15 M @ 600 (24)
2.74 (9.0)	15 M @ 200 (8)	15 M @ 400 (16)	15 M @ 400 (16)	15 M @ 600 (24)	15 M @ 200 (8)	15 M @ 300 (12)	15 M @ 400 (16)	15 M @ 400 (16)	
3.05 (10.0)	15 M @ 200 (8)	15 M @ 200 (8)	15 M @ 400 (16)	15 M @ 400 (16)		15 M @ 200 (8)	15 M @ 400 (16)	15 M @ 200 (8)	
3.35 (11.0)	15 M @ 200 (8)	15 M @ 200 (8)	15 M @ 400 (16)	15 M @ 400 (16)		15 M @ 200 (8)	15 M @ 200 (8)	15 M @ 200 (8)	
3.66 (12.0)	1.22 (4.0)	15 M @ 600 (24)	10 M @ 400 (16)	10 M @ 600 (24)	10 M @ 800 (32)	15 M @ 600 (24)	15 M @ 800 (32)	10 M @ 600 (24)	10 M @ 800 (32)
	1.53 (5.0)	15 M @ 600 (24)	15 M @ 800 (32)	10 M @ 400 (16)	10 M @ 600 (24)	15 M @ 400 (16)	15 M @ 600 (24)	10 M @ 400 (16)	10 M @ 600 (24)
	1.83 (6.0)	15 M @ 400 (16)	15 M @ 600 (24)	10 M @ 400 (16)	10 M @ 600 (24)	15 M @ 400 (16)	15 M @ 600 (24)	15 M @ 800 (32)	15 M @ 800 (32)
	2.13 (7.0)	15 M @ 400 (16)	15 M @ 600 (24)	15 M @ 600 (24)	15 M @ 800 (32)	15 M @ 200 (8)	15 M @ 400 (16)	15 M @ 600 (24)	15 M @ 600 (24)
	2.44 (8.0)	15 M @ 200 (8)	15 M @ 400 (16)	15 M @ 600 (24)	15 M @ 600 (24)	15 M @ 200 (8)	15 M @ 400 (16)	15 M @ 400 (16)	15 M @ 400 (16)
2.74 (9.0)	15 M @ 200 (8)	15 M @ 200 (8)	15 M @ 400 (16)	15 M @ 600 (24)	15 M @ 200 (8)	15 M @ 200 (8)	15 M @ 400 (16)	15 M @ 400 (16)	
3.05 (10.0)	15 M @ 200 (8)	15 M @ 200 (8)	15 M @ 400 (16)	15 M @ 400 (16)		15 M @ 200 (8)	15 M @ 200 (8)	15 M @ 200 (8)	
3.35 (11.0)	15 M @ 200 (8)	15 M @ 200 (8)	15 M @ 200 (8)	15 M @ 400 (16)		15 M @ 200 (8)	15 M @ 200 (8)	15 M @ 200 (8)	
3.66 (12.0)	15 M @ 200 (8)	15 M @ 200 (8)	15 M @ 200 (8)	15 M @ 200 (8)			15 M @ 200 (8)	15 M @ 200 (8)	
Horizontal Reinforcement	Block Height of 12" and 18"	10 M @ 900 (36)	10 M @ 900 (36)	10 M @ 900 (36)	10 M @ 900 (36)	10 M @ 900 (36)	10 M @ 900 (36)	10 M @ 900 (36)	10 M @ 900 (36)
	Block Height of 16"	10 M @ 800 (32)	10 M @ 800 (32)	10 M @ 800 (32)	10 M @ 800 (32)	10 M @ 800 (32)	10 M @ 800 (32)	10 M @ 800 (32)	10 M @ 800 (32)

**NOTES:**

- For highlighted data, where the below grade wall meets all the requirements of NBCC Part 9 for a solid concrete foundation wall and supports only wood frame construction above, a 20MPa unreinforced wall is adequate as per 2020 NBCC table 9.15.4.2.A. Provide the reinforcing shown for walls supporting ICF walls above or with brick veneer supported with the brick ledge form.
- Below grade walls supporting "Drained Earth" in accordance with 2020 NBCC 9.4.4.6 may be designed for an equivalent fluid pressure of 480 kg/m<sup>3</sup>.
- This table is to be used in conjunction with the "Design Limitations" and "Below Grade Reinforcement Placement" drawing.

**Table B.1.2. Continued – Below Grade Wall Distributed Reinforcement for Seismic Zone Classification,  $S_{a,ICF} \leq 0.11$  and Hourly Wind Pressure,  $q_{1/50} \leq 1.05\text{kPa}$ , for ICF Walls with 8" Tie Spacing**

Wall Height m (ft)	Backfill Height m (ft)	Vertical Steel (Size and Spacing)							
		Backfill Equivalent Fluid Density							
		960 kg/m <sup>3</sup> (60 pcf)				1200 kg/m <sup>3</sup> (75 pcf)			
		150 mm (6") Wall	200 mm (8") Wall	250 mm (10") Wall	300 mm (12") Wall	150 mm (6") Wall	200 mm (8") Wall	250 mm (10") Wall	300 mm (12") Wall
2.44 (8.0)	1.22 (4.0)	15 M @ 600 (24)	10 M @ 400 (16)	10 M @ 800 (32)	10 M @ 800 (32)	15 M @ 600 (24)	10 M @ 400 (16)	10 M @ 600 (24)	10 M @ 800 (32)
	1.53 (5.0)	15 M @ 400 (16)	10 M @ 400 (16)	10 M @ 600 (24)	10 M @ 800 (32)	15 M @ 400 (16)	15 M @ 800 (32)	15 M @ 800 (32)	10 M @ 600 (24)
	1.83 (6.0)	15 M @ 400 (16)	15 M @ 600 (24)	10 M @ 400 (16)	10 M @ 600 (24)	15 M @ 400 (16)	15 M @ 400 (16)	15 M @ 600 (24)	15 M @ 800 (32)
	2.13 (7.0)	15 M @ 400 (16)	15 M @ 400 (16)	15 M @ 600 (24)	15 M @ 800 (32)	15 M @ 200 (8)	15 M @ 400 (16)	15 M @ 400 (16)	15 M @ 600 (24)
	2.44 (8.0)	15 M @ 200 (8)	15 M @ 400 (16)	15 M @ 400 (16)	15 M @ 600 (24)	15 M @ 200 (8)	15 M @ 400 (16)	15 M @ 400 (16)	15 M @ 400 (16)
2.74 (9.0)	1.22 (4.0)	15 M @ 600 (24)	10 M @ 400 (16)	10 M @ 600 (24)	10 M @ 800 (32)	15 M @ 600 (24)	15 M @ 800 (32)	10 M @ 400 (16)	10 M @ 800 (32)
	1.53 (5.0)	15 M @ 400 (16)	15 M @ 600 (24)	15 M @ 800 (32)	10 M @ 800 (32)	15 M @ 400 (16)	15 M @ 600 (24)	15 M @ 800 (32)	10 M @ 600 (24)
	1.83 (6.0)	15 M @ 400 (16)	15 M @ 400 (16)	15 M @ 800 (32)	10 M @ 600 (24)	15 M @ 400 (16)	15 M @ 400 (16)	15 M @ 600 (24)	15 M @ 800 (32)
	2.13 (7.0)	15 M @ 200 (8)	15 M @ 400 (16)	15 M @ 600 (24)	15 M @ 600 (24)	15 M @ 200 (8)	15 M @ 400 (16)	15 M @ 400 (16)	15 M @ 600 (24)
	2.44 (8.0)	15 M @ 200 (8)	15 M @ 400 (16)	15 M @ 400 (16)	15 M @ 400 (16)	15 M @ 200 (8)	15 M @ 400 (16)	15 M @ 400 (16)	15 M @ 600 (24)
	2.74 (9.0)	15 M @ 200 (8)	15 M @ 200 (8)	15 M @ 400 (16)	15 M @ 400 (16)	15 M @ 200 (8)	15 M @ 400 (16)	15 M @ 400 (16)	15 M @ 200 (8)
3.05 (10.0)	1.22 (4.0)	15 M @ 600 (24)	10 M @ 400 (16)	10 M @ 600 (24)	10 M @ 800 (32)	15 M @ 600 (24)	15 M @ 800 (32)	15 M @ 800 (32)	10 M @ 800 (32)
	1.53 (5.0)	15 M @ 400 (16)	15 M @ 600 (24)	10 M @ 400 (16)	10 M @ 600 (24)	15 M @ 400 (16)	15 M @ 600 (24)	15 M @ 800 (32)	10 M @ 400 (16)
	1.83 (6.0)	15 M @ 400 (16)	15 M @ 400 (16)	15 M @ 600 (24)	15 M @ 800 (32)	15 M @ 400 (16)	15 M @ 400 (16)	15 M @ 600 (24)	10 M @ 600 (24)
	2.13 (7.0)	15 M @ 200 (8)	15 M @ 400 (16)	15 M @ 400 (16)	15 M @ 600 (24)	15 M @ 200 (8)	15 M @ 400 (16)	15 M @ 400 (16)	15 M @ 400 (16)
	2.44 (8.0)	15 M @ 200 (8)	15 M @ 400 (16)	15 M @ 400 (16)	15 M @ 400 (16)	15 M @ 200 (8)	15 M @ 200 (8)	15 M @ 400 (16)	15 M @ 400 (16)
	2.74 (9.0)	15 M @ 200 (8)	15 M @ 200 (8)	15 M @ 400 (16)	15 M @ 400 (16)	15 M @ 200 (8)	15 M @ 400 (16)	15 M @ 400 (16)	15 M @ 200 (8)
	3.05 (10.0)	15 M @ 200 (8)	15 M @ 200 (8)	15 M @ 200 (8)	15 M @ 200 (8)	15 M @ 200 (8)	15 M @ 200 (8)	15 M @ 200 (8)	15 M @ 200 (8)
3.35 (11.0)	1.22 (4.0)	15 M @ 600 (24)	15 M @ 600 (24)	10 M @ 600 (24)	10 M @ 800 (32)	15 M @ 600 (24)	15 M @ 800 (32)	15 M @ 800 (32)	10 M @ 600 (24)
	1.53 (5.0)	15 M @ 400 (16)	15 M @ 600 (24)	15 M @ 800 (32)	10 M @ 400 (16)	15 M @ 400 (16)	15 M @ 600 (24)	15 M @ 800 (32)	10 M @ 400 (16)
	1.83 (6.0)	15 M @ 400 (16)	15 M @ 400 (16)	15 M @ 600 (24)	15 M @ 800 (32)	15 M @ 200 (8)	15 M @ 400 (16)	15 M @ 600 (24)	15 M @ 600 (24)
	2.13 (7.0)	15 M @ 200 (8)	15 M @ 400 (16)	15 M @ 400 (16)	15 M @ 600 (24)	15 M @ 200 (8)	15 M @ 400 (16)	15 M @ 400 (16)	15 M @ 400 (16)
	2.44 (8.0)	15 M @ 200 (8)	15 M @ 200 (8)	15 M @ 400 (16)	15 M @ 400 (16)	15 M @ 200 (8)	15 M @ 400 (16)	15 M @ 200 (8)	15 M @ 200 (8)
	2.74 (9.0)	15 M @ 200 (8)	15 M @ 200 (8)	15 M @ 400 (16)	15 M @ 400 (16)	15 M @ 200 (8)	15 M @ 200 (8)	15 M @ 200 (8)	15 M @ 200 (8)
	3.05 (10.0)	15 M @ 200 (8)	15 M @ 200 (8)	15 M @ 200 (8)	15 M @ 200 (8)	15 M @ 200 (8)	15 M @ 200 (8)	15 M @ 200 (8)	15 M @ 200 (8)
	3.35 (11.0)	15 M @ 200 (8)	15 M @ 200 (8)	15 M @ 200 (8)	15 M @ 200 (8)	15 M @ 200 (8)	15 M @ 200 (8)	15 M @ 200 (8)	15 M @ 200 (8)
3.66 (12.0)	1.22 (4.0)	15 M @ 600 (24)	15 M @ 600 (24)	10 M @ 400 (16)	10 M @ 800 (32)	15 M @ 400 (16)	15 M @ 600 (24)	15 M @ 800 (32)	10 M @ 600 (24)
	1.53 (5.0)	15 M @ 400 (16)	15 M @ 400 (16)	15 M @ 800 (32)	10 M @ 400 (16)	15 M @ 400 (16)	15 M @ 400 (16)	15 M @ 600 (24)	15 M @ 800 (32)
	1.83 (6.0)	15 M @ 400 (16)	15 M @ 400 (16)	15 M @ 600 (24)	15 M @ 800 (32)	15 M @ 200 (8)	15 M @ 400 (16)	15 M @ 400 (16)	15 M @ 600 (24)
	2.13 (7.0)	15 M @ 200 (8)	15 M @ 400 (16)	15 M @ 400 (16)	15 M @ 400 (16)	15 M @ 200 (8)	15 M @ 400 (16)	15 M @ 400 (16)	15 M @ 400 (16)
	2.44 (8.0)	15 M @ 200 (8)	15 M @ 200 (8)	15 M @ 400 (16)	15 M @ 400 (16)	15 M @ 200 (8)	15 M @ 400 (16)	15 M @ 200 (8)	15 M @ 200 (8)
	2.74 (9.0)	15 M @ 200 (8)	15 M @ 200 (8)	15 M @ 200 (8)	15 M @ 200 (8)	15 M @ 200 (8)	15 M @ 200 (8)	15 M @ 200 (8)	15 M @ 200 (8)
	3.05 (10.0)	15 M @ 200 (8)	15 M @ 200 (8)	15 M @ 200 (8)	15 M @ 200 (8)	15 M @ 200 (8)	15 M @ 200 (8)	15 M @ 200 (8)	15 M @ 200 (8)
	3.35 (11.0)	15 M @ 200 (8)	15 M @ 200 (8)	15 M @ 200 (8)	15 M @ 200 (8)	15 M @ 200 (8)	15 M @ 200 (8)	15 M @ 200 (8)	15 M @ 200 (8)
	3.66 (12.0)	15 M @ 200 (8)	15 M @ 200 (8)	15 M @ 200 (8)	15 M @ 200 (8)	15 M @ 200 (8)	15 M @ 200 (8)	15 M @ 200 (8)	15 M @ 200 (8)
Horizontal Reinforcement	Block Height of 12" and 18"	10 M @ 900 (36)	10 M @ 900 (36)	10 M @ 900 (36)	10 M @ 900 (36)	10 M @ 900 (36)	10 M @ 900 (36)	10 M @ 900 (36)	10 M @ 900 (36)
	Block Height of 16"	10 M @ 800 (32)	10 M @ 800 (32)	10 M @ 800 (32)	10 M @ 800 (32)	10 M @ 800 (32)	10 M @ 800 (32)	10 M @ 800 (32)	10 M @ 800 (32)

NOTES:

- For highlighted data, where the below grade wall meets all the requirements of NBCC Part 9 for a solid concrete foundation wall and supports only wood frame construction above, a 20MPa unreinforced wall is adequate as per 2020 NBCC table 9.15.4.2.A. Provide the reinforcing shown for walls supporting ICF walls above or with brick veneer supported with the brick ledge form.
- Below grade walls supporting "Drained Earth" in accordance with 2020 NBCC 9.4.4.6 may be designed for an equivalent fluid pressure of 480 kg/m<sup>3</sup>.
- This table is to be used in conjunction with the "Design Limitations" and "Below Grade Reinforcement Placement" drawing.

**Table B.2.1. – Below Grade Wall Distributed Reinforcement for Seismic Zone Classification, 0.11 < S<sub>a,ICF</sub> ≤ 0.16 and Hourly Wind Pressure, q<sub>1/50</sub> ≤ 1.05kPa, for ICF Walls with 6” Tie Spacing**

Wall Height m (ft)	Backfill Height m (ft)	Vertical Steel (Size and Spacing)							
		Backfill Equivalent Fluid Density							
		480 kg/m <sup>3</sup> (30 pcf)				720 kg/m <sup>3</sup> (45 pcf)			
		150 mm (6") Wall	200 mm (8") Wall	250 mm (10") Wall	300 mm (12") Wall	150 mm (6") Wall	200 mm (8") Wall	250 mm (10") Wall	300 mm (12") Wall
2.44 (8.0)	1.22 (4.0)	10 M @ 450 (18)	10 M @ 600 (24)	10 M @ 450 (18)	10 M @ 450 (18)	15 M @ 450 (18)	10 M @ 450 (18)	10 M @ 450 (18)	10 M @ 450 (18)
	1.53 (5.0)	15 M @ 600 (24)	15 M @ 600 (24)	10 M @ 450 (18)	10 M @ 450 (18)	15 M @ 450 (18)	15 M @ 600 (24)	10 M @ 450 (18)	10 M @ 450 (18)
	1.83 (6.0)	15 M @ 450 (18)	15 M @ 600 (24)	15 M @ 600 (24)	15 M @ 600 (24)	15 M @ 450 (18)	15 M @ 450 (18)	15 M @ 600 (24)	15 M @ 600 (24)
	2.13 (7.0)	15 M @ 300 (12)	15 M @ 450 (18)	15 M @ 600 (24)	15 M @ 600 (24)	15 M @ 300 (12)	15 M @ 450 (18)	15 M @ 450 (18)	15 M @ 600 (24)
	2.44 (8.0)	15 M @ 300 (12)	15 M @ 450 (18)	15 M @ 600 (24)	15 M @ 600 (24)	15 M @ 150 (6)	15 M @ 450 (18)	15 M @ 450 (18)	15 M @ 600 (24)
2.74 (9.0)	1.22 (4.0)	15 M @ 600 (24)	10 M @ 450 (18)	10 M @ 450 (18)	10 M @ 450 (18)	15 M @ 600 (24)	10 M @ 450 (18)	10 M @ 450 (18)	10 M @ 450 (18)
	1.53 (5.0)	15 M @ 450 (18)	15 M @ 600 (24)	10 M @ 450 (18)	10 M @ 450 (18)	15 M @ 450 (18)	15 M @ 600 (24)	10 M @ 450 (18)	10 M @ 450 (18)
	1.83 (6.0)	15 M @ 450 (18)	15 M @ 600 (24)	15 M @ 600 (24)	15 M @ 600 (24)	15 M @ 300 (12)	15 M @ 450 (18)	15 M @ 600 (24)	15 M @ 600 (24)
	2.13 (7.0)	15 M @ 300 (12)	15 M @ 450 (18)	15 M @ 600 (24)	15 M @ 600 (24)	15 M @ 300 (12)	15 M @ 450 (18)	15 M @ 450 (18)	15 M @ 600 (24)
	2.44 (8.0)	15 M @ 150 (6)	15 M @ 300 (12)	15 M @ 450 (18)	15 M @ 600 (24)	15 M @ 150 (6)	15 M @ 300 (12)	15 M @ 450 (18)	15 M @ 450 (18)
3.05 (10.0)	1.22 (4.0)	15 M @ 600 (24)	10 M @ 450 (18)	10 M @ 450 (18)	10 M @ 450 (18)	15 M @ 600 (24)	10 M @ 450 (18)	10 M @ 450 (18)	10 M @ 450 (18)
	1.53 (5.0)	15 M @ 450 (18)	15 M @ 600 (24)	10 M @ 450 (18)	10 M @ 450 (18)	15 M @ 450 (18)	15 M @ 600 (24)	10 M @ 450 (18)	10 M @ 450 (18)
	1.83 (6.0)	15 M @ 300 (12)	15 M @ 450 (18)	15 M @ 600 (24)	15 M @ 600 (24)	15 M @ 300 (12)	15 M @ 450 (18)	15 M @ 600 (24)	15 M @ 600 (24)
	2.13 (7.0)	15 M @ 300 (12)	15 M @ 450 (18)	15 M @ 450 (18)	15 M @ 600 (24)	15 M @ 150 (6)	15 M @ 300 (12)	15 M @ 450 (18)	15 M @ 600 (24)
	2.44 (8.0)	15 M @ 150 (6)	15 M @ 300 (12)	15 M @ 450 (18)	15 M @ 450 (18)	15 M @ 150 (6)	15 M @ 300 (12)	15 M @ 450 (18)	15 M @ 450 (18)
3.35 (11.0)	1.22 (4.0)	15 M @ 600 (24)	10 M @ 450 (18)	10 M @ 450 (18)	10 M @ 450 (18)	15 M @ 600 (24)	10 M @ 450 (18)	10 M @ 450 (18)	10 M @ 450 (18)
	1.53 (5.0)	15 M @ 450 (18)	15 M @ 600 (24)	10 M @ 450 (18)	10 M @ 450 (18)	15 M @ 450 (18)	15 M @ 600 (24)	10 M @ 450 (18)	10 M @ 450 (18)
	1.83 (6.0)	15 M @ 300 (12)	15 M @ 450 (18)	15 M @ 600 (24)	15 M @ 600 (24)	15 M @ 300 (12)	15 M @ 450 (18)	15 M @ 600 (24)	15 M @ 600 (24)
	2.13 (7.0)	15 M @ 150 (6)	15 M @ 450 (18)	15 M @ 450 (18)	15 M @ 600 (24)	15 M @ 150 (6)	15 M @ 300 (12)	15 M @ 450 (18)	15 M @ 450 (18)
	2.44 (8.0)	15 M @ 150 (6)	15 M @ 300 (12)	15 M @ 450 (18)	15 M @ 450 (18)	15 M @ 150 (6)	15 M @ 300 (12)	15 M @ 450 (18)	15 M @ 600 (24)
3.66 (12.0)	1.22 (4.0)	15 M @ 600 (24)	10 M @ 450 (18)	10 M @ 450 (18)	10 M @ 450 (18)	15 M @ 600 (24)	15 M @ 600 (24)	10 M @ 450 (18)	10 M @ 450 (18)
	1.53 (5.0)	15 M @ 450 (18)	15 M @ 600 (24)	10 M @ 450 (18)	10 M @ 450 (18)	15 M @ 450 (18)	15 M @ 600 (24)	15 M @ 600 (24)	10 M @ 450 (18)
	1.83 (6.0)	15 M @ 300 (12)	15 M @ 450 (18)	15 M @ 600 (24)	15 M @ 600 (24)	15 M @ 300 (12)	15 M @ 450 (18)	15 M @ 450 (18)	15 M @ 600 (24)
	2.13 (7.0)	15 M @ 150 (6)	15 M @ 300 (12)	15 M @ 450 (18)	15 M @ 600 (24)	15 M @ 150 (6)	15 M @ 300 (12)	15 M @ 450 (18)	15 M @ 450 (18)
	2.44 (8.0)	15 M @ 150 (6)	15 M @ 300 (12)	15 M @ 300 (12)	15 M @ 450 (18)	15 M @ 150 (6)	15 M @ 300 (12)	15 M @ 450 (18)	15 M @ 450 (18)
Horizontal Reinforcement	Block Height of 12" and 18"	10 M @ 450 (18)	10 M @ 450 (18)	10 M @ 450 (18)	10 M @ 450 (18)	10 M @ 450 (18)	10 M @ 450 (18)	10 M @ 450 (18)	10 M @ 450 (18)
	Block Height of 16"	10 M @ 400 (16)	10 M @ 400 (16)	10 M @ 400 (16)	10 M @ 400 (16)	10 M @ 400 (16)	10 M @ 400 (16)	10 M @ 400 (16)	10 M @ 400 (16)

**NOTES:**

- For highlighted data, where the below grade wall meets all the requirements of NBCC Part 9 for a solid concrete foundation wall and supports only wood frame construction above, a 20MPa unreinforced wall is adequate as per 2020 NBCC table 9.15.4.2.A. Provide the reinforcing shown for walls supporting ICF walls above or with brick veneer supported with the brick ledge form.
- Below grade walls supporting "Drained Earth" in accordance with 2020 NBCC 9.4.4.6 may be designed for an equivalent fluid pressure of 480 kg/m<sup>3</sup>.
- This table is to be used in conjunction with the "Design Limitations" and "Below Grade Reinforcement Placement" drawing.
- Alternating horizontal bar spacing of 12" o.c. and 24" o.c. may be used to achieve an average spacing of 18" o.c. where 18" o.c. spacing is specified for horizontal bars, as shown in Detail A.3.

INSULATING CONCRETE FORMS  
MANUFACTURERS ASSOCIATION

**Table B.2.1. Continued – Below Grade Wall Distributed Reinforcement for Seismic Zone Classification,  $0.11 < S_{a,ICF} \leq 0.16$  and Hourly Wind Pressure,  $q_{1/50} \leq 1.05\text{kPa}$ , for ICF Walls with 6" Tie Spacing**

Wall Height m (ft)	Backfill Height m (ft)	Vertical Steel (Size and Spacing)							
		Backfill Equivalent Fluid Density							
		960 kg/m <sup>3</sup> (60 pcf)				1200 kg/m <sup>3</sup> (75 pcf)			
		150 mm (6") Wall	200 mm (8") Wall	250 mm (10") Wall	300 mm (12") Wall	150 mm (6") Wall	200 mm (8") Wall	250 mm (10") Wall	300 mm (12") Wall
2.44 (8.0)	1.22 (4.0)	15 M @ 450 (18)	10 M @ 450 (18)	10 M @ 450 (18)	10 M @ 450 (18)	15 M @ 450 (18)	10 M @ 450 (18)	10 M @ 450 (18)	10 M @ 450 (18)
	1.53 (5.0)	15 M @ 450 (18)	15 M @ 600 (24)	10 M @ 450 (18)	10 M @ 450 (18)	15 M @ 450 (18)	15 M @ 600 (24)	10 M @ 450 (18)	10 M @ 450 (18)
	1.83 (6.0)	15 M @ 300 (12)	15 M @ 450 (18)	15 M @ 600 (24)	10 M @ 450 (18)	15 M @ 300 (12)	15 M @ 450 (18)	15 M @ 600 (24)	15 M @ 600 (24)
	2.13 (7.0)	15 M @ 300 (12)	15 M @ 450 (18)	15 M @ 450 (18)	15 M @ 600 (24)	15 M @ 150 (6)	15 M @ 300 (12)	15 M @ 450 (18)	15 M @ 600 (24)
2.74 (9.0)	1.22 (4.0)	15 M @ 600 (24)	15 M @ 600 (24)	10 M @ 450 (18)	10 M @ 450 (18)	15 M @ 600 (24)	15 M @ 600 (24)	10 M @ 450 (18)	10 M @ 450 (18)
	1.53 (5.0)	15 M @ 450 (18)	15 M @ 600 (24)	10 M @ 450 (18)	10 M @ 450 (18)	15 M @ 450 (18)	15 M @ 600 (24)	10 M @ 450 (18)	10 M @ 450 (18)
	1.83 (6.0)	15 M @ 300 (12)	15 M @ 450 (18)	15 M @ 600 (24)	15 M @ 600 (24)	15 M @ 300 (12)	15 M @ 450 (18)	15 M @ 450 (18)	15 M @ 600 (24)
	2.13 (7.0)	15 M @ 150 (6)	15 M @ 300 (12)	15 M @ 450 (18)	15 M @ 600 (24)	15 M @ 150 (6)	15 M @ 300 (12)	15 M @ 450 (18)	15 M @ 450 (18)
3.05 (10.0)	1.22 (4.0)	15 M @ 600 (24)	15 M @ 600 (24)	10 M @ 450 (18)	10 M @ 450 (18)	15 M @ 600 (24)	15 M @ 600 (24)	10 M @ 450 (18)	10 M @ 450 (18)
	1.53 (5.0)	15 M @ 450 (18)	15 M @ 600 (24)	10 M @ 450 (18)	10 M @ 450 (18)	15 M @ 450 (18)	15 M @ 600 (24)	15 M @ 600 (24)	10 M @ 450 (18)
	1.83 (6.0)	15 M @ 300 (12)	15 M @ 450 (18)	15 M @ 600 (24)	15 M @ 600 (24)	15 M @ 300 (12)	15 M @ 450 (18)	15 M @ 450 (18)	15 M @ 600 (24)
	2.13 (7.0)	15 M @ 150 (6)	15 M @ 300 (12)	15 M @ 450 (18)	15 M @ 450 (18)	15 M @ 150 (6)	15 M @ 300 (12)	15 M @ 450 (18)	15 M @ 450 (18)
3.35 (11.0)	1.22 (4.0)	15 M @ 600 (24)	15 M @ 600 (24)	10 M @ 450 (18)	10 M @ 450 (18)	15 M @ 600 (24)	15 M @ 600 (24)	10 M @ 450 (18)	10 M @ 450 (18)
	1.53 (5.0)	15 M @ 450 (18)	15 M @ 600 (24)	10 M @ 450 (18)	10 M @ 450 (18)	15 M @ 450 (18)	15 M @ 600 (24)	15 M @ 600 (24)	10 M @ 450 (18)
	1.83 (6.0)	15 M @ 300 (12)	15 M @ 450 (18)	15 M @ 450 (18)	15 M @ 600 (24)	15 M @ 150 (6)	15 M @ 450 (18)	15 M @ 450 (18)	15 M @ 600 (24)
	2.13 (7.0)	15 M @ 150 (6)	15 M @ 300 (12)	15 M @ 450 (18)	15 M @ 450 (18)	15 M @ 150 (6)	15 M @ 300 (12)	15 M @ 450 (18)	15 M @ 450 (18)
3.66 (12.0)	1.22 (4.0)	15 M @ 600 (24)	15 M @ 600 (24)	10 M @ 450 (18)	10 M @ 450 (18)	15 M @ 450 (18)	15 M @ 600 (24)	10 M @ 450 (18)	10 M @ 450 (18)
	1.53 (5.0)	15 M @ 450 (18)	15 M @ 600 (24)	15 M @ 600 (24)	10 M @ 450 (18)	15 M @ 450 (18)	15 M @ 450 (18)	15 M @ 600 (24)	10 M @ 450 (18)
	1.83 (6.0)	15 M @ 150 (6)	15 M @ 450 (18)	15 M @ 450 (18)	15 M @ 600 (24)	15 M @ 150 (6)	15 M @ 300 (12)	15 M @ 450 (18)	15 M @ 600 (24)
	2.13 (7.0)	15 M @ 150 (6)	15 M @ 300 (12)	15 M @ 450 (18)	15 M @ 450 (18)	15 M @ 150 (6)	15 M @ 300 (12)	15 M @ 300 (12)	15 M @ 450 (18)
Horizontal Reinforcement	Block Height of 12" and 18"	10 M @ 450 (18)	10 M @ 450 (18)	10 M @ 450 (18)	10 M @ 450 (18)	10 M @ 450 (18)	10 M @ 450 (18)	10 M @ 450 (18)	10 M @ 450 (18)
	Block Height of 16"	10 M @ 400 (16)	10 M @ 400 (16)	10 M @ 400 (16)	10 M @ 400 (16)	10 M @ 400 (16)	10 M @ 400 (16)	10 M @ 400 (16)	10 M @ 400 (16)

**NOTES:**

- For highlighted data, where the below grade wall meets all the requirements of NBCC Part 9 for a solid concrete foundation wall and supports only wood frame construction above, a 20MPa unreinforced wall is adequate as per 2020 NBCC table 9.15.4.2.A. Provide the reinforcing shown for walls supporting ICF walls above or with brick veneer supported with the brick ledge form.
- Below grade walls supporting "Drained Earth" in accordance with 2020 NBCC 9.4.4.6 may be designed for an equivalent fluid pressure of 480 kg/m<sup>3</sup>.
- This table is to be used in conjunction with the "Design Limitations" and "Below Grade Reinforcement Placement" drawing.
- Alternating horizontal bar spacing of 12" o.c. and 24" o.c. may be used to achieve an average spacing of 18" o.c. where 18" o.c. spacing is specified for horizontal bars, as shown in Detail A.3.

**Table B.2.2. – Below Grade Wall Distributed Reinforcement for Seismic Zone Classification,  $0.11 < S_{a,ICF} \leq 0.16$  and Hourly Wind Pressure,  $q_{1/50} \leq 1.05\text{kPa}$ , for ICF Walls with 8" Tie Spacing**

Wall Height m (ft)	Backfill Height m (ft)	Vertical Steel (Size and Spacing)							
		Backfill Equivalent Fluid Density							
		480 kg/m <sup>3</sup> (30 pcf)				720 kg/m <sup>3</sup> (45 pcf)			
		150 mm (6") Wall	200 mm (8") Wall	250 mm (10") Wall	300 mm (12") Wall	150 mm (6") Wall	200 mm (8") Wall	250 mm (10") Wall	300 mm (12") Wall
2.44 (8.0)	1.22 (4.0)	10 M @ 400 (16)	10 M @ 600 (24)	10 M @ 400 (16)	10 M @ 400 (16)	15 M @ 400 (16)	10 M @ 400 (16)	10 M @ 400 (16)	10 M @ 400 (16)
	1.53 (5.0)	15 M @ 600 (24)	15 M @ 600 (24)	10 M @ 400 (16)	10 M @ 400 (16)	15 M @ 400 (16)	15 M @ 600 (24)	10 M @ 400 (16)	10 M @ 400 (16)
	1.83 (6.0)	15 M @ 400 (16)	15 M @ 600 (24)	15 M @ 600 (24)	15 M @ 600 (24)	15 M @ 400 (16)	15 M @ 400 (16)	15 M @ 600 (24)	15 M @ 600 (24)
	2.13 (7.0)	15 M @ 400 (16)	15 M @ 400 (16)	15 M @ 600 (24)	15 M @ 600 (24)	15 M @ 200 (8)	15 M @ 400 (16)	15 M @ 400 (16)	15 M @ 600 (24)
	2.44 (8.0)	15 M @ 200 (8)	15 M @ 400 (16)	15 M @ 600 (24)	15 M @ 600 (24)	15 M @ 200 (8)	15 M @ 400 (16)	15 M @ 400 (16)	15 M @ 600 (24)
2.74 (9.0)	1.22 (4.0)	15 M @ 600 (24)	10 M @ 400 (16)	10 M @ 400 (16)	10 M @ 400 (16)	15 M @ 600 (24)	10 M @ 400 (16)	10 M @ 400 (16)	10 M @ 400 (16)
	1.53 (5.0)	15 M @ 400 (16)	15 M @ 600 (24)	10 M @ 400 (16)	10 M @ 400 (16)	15 M @ 400 (16)	15 M @ 600 (24)	15 M @ 600 (24)	10 M @ 400 (16)
	1.83 (6.0)	15 M @ 400 (16)	15 M @ 600 (24)	15 M @ 600 (24)	15 M @ 600 (24)	15 M @ 400 (16)	15 M @ 400 (16)	15 M @ 600 (24)	15 M @ 600 (24)
	2.13 (7.0)	15 M @ 200 (8)	15 M @ 400 (16)	15 M @ 600 (24)	15 M @ 600 (24)	15 M @ 200 (8)	15 M @ 400 (16)	15 M @ 400 (16)	15 M @ 600 (24)
	2.44 (8.0)	15 M @ 200 (8)	15 M @ 400 (16)	15 M @ 400 (16)	15 M @ 400 (16)	15 M @ 200 (8)	15 M @ 400 (16)	15 M @ 400 (16)	15 M @ 600 (24)
	2.74 (9.0)	15 M @ 200 (8)	15 M @ 400 (16)	15 M @ 400 (16)	15 M @ 400 (16)	15 M @ 200 (8)	15 M @ 400 (16)	15 M @ 400 (16)	15 M @ 400 (16)
3.05 (10.0)	1.22 (4.0)	15 M @ 600 (24)	10 M @ 400 (16)	10 M @ 400 (16)	10 M @ 400 (16)	15 M @ 600 (24)	10 M @ 400 (16)	10 M @ 400 (16)	10 M @ 400 (16)
	1.53 (5.0)	15 M @ 400 (16)	15 M @ 600 (24)	10 M @ 400 (16)	10 M @ 400 (16)	15 M @ 400 (16)	15 M @ 600 (24)	10 M @ 400 (16)	10 M @ 400 (16)
	1.83 (6.0)	15 M @ 400 (16)	15 M @ 400 (16)	15 M @ 600 (24)	15 M @ 600 (24)	15 M @ 200 (8)	15 M @ 400 (16)	15 M @ 600 (24)	15 M @ 600 (24)
	2.13 (7.0)	15 M @ 200 (8)	15 M @ 400 (16)	15 M @ 400 (16)	15 M @ 600 (24)	15 M @ 200 (8)	15 M @ 400 (16)	15 M @ 400 (16)	15 M @ 600 (24)
	2.44 (8.0)	15 M @ 200 (8)	15 M @ 400 (16)	15 M @ 400 (16)	15 M @ 400 (16)	15 M @ 200 (8)	15 M @ 200 (8)	15 M @ 400 (16)	15 M @ 400 (16)
	2.74 (9.0)	15 M @ 200 (8)	15 M @ 200 (8)	15 M @ 400 (16)	15 M @ 400 (16)	15 M @ 200 (8)	15 M @ 200 (8)	15 M @ 200 (8)	15 M @ 400 (16)
3.35 (11.0)	1.22 (4.0)	15 M @ 600 (24)	10 M @ 400 (16)	10 M @ 400 (16)	10 M @ 400 (16)	15 M @ 600 (24)	10 M @ 400 (16)	10 M @ 400 (16)	10 M @ 400 (16)
	1.53 (5.0)	15 M @ 400 (16)	15 M @ 600 (24)	10 M @ 400 (16)	10 M @ 400 (16)	15 M @ 400 (16)	15 M @ 600 (24)	10 M @ 400 (16)	10 M @ 400 (16)
	1.83 (6.0)	15 M @ 200 (8)	15 M @ 400 (16)	15 M @ 600 (24)	15 M @ 600 (24)	15 M @ 200 (8)	15 M @ 400 (16)	15 M @ 600 (24)	15 M @ 600 (24)
	2.13 (7.0)	15 M @ 200 (8)	15 M @ 400 (16)	15 M @ 400 (16)	15 M @ 600 (24)	15 M @ 200 (8)	15 M @ 400 (16)	15 M @ 400 (16)	15 M @ 400 (16)
	2.44 (8.0)	15 M @ 200 (8)	15 M @ 200 (8)	15 M @ 400 (16)	15 M @ 400 (16)		15 M @ 200 (8)	15 M @ 400 (16)	15 M @ 400 (16)
	2.74 (9.0)		15 M @ 200 (8)	15 M @ 200 (8)	15 M @ 400 (16)		15 M @ 200 (8)	15 M @ 400 (16)	15 M @ 400 (16)
3.66 (12.0)	1.22 (4.0)	15 M @ 600 (24)	10 M @ 400 (16)	10 M @ 400 (16)	10 M @ 400 (16)	15 M @ 600 (24)	15 M @ 600 (24)	10 M @ 400 (16)	10 M @ 400 (16)
	1.53 (5.0)	15 M @ 400 (16)	15 M @ 600 (24)	10 M @ 400 (16)	10 M @ 400 (16)	15 M @ 400 (16)	15 M @ 600 (24)	15 M @ 600 (24)	10 M @ 400 (16)
	1.83 (6.0)	15 M @ 200 (8)	15 M @ 400 (16)	15 M @ 600 (24)	15 M @ 600 (24)	15 M @ 200 (8)	15 M @ 400 (16)	15 M @ 400 (16)	15 M @ 600 (24)
	2.13 (7.0)	15 M @ 200 (8)	15 M @ 400 (16)	15 M @ 400 (16)	15 M @ 600 (24)	15 M @ 200 (8)	15 M @ 200 (8)	15 M @ 400 (16)	15 M @ 400 (16)
	2.44 (8.0)		15 M @ 200 (8)	15 M @ 400 (16)	15 M @ 400 (16)		15 M @ 200 (8)	15 M @ 200 (8)	15 M @ 400 (16)
	2.74 (9.0)		15 M @ 200 (8)	15 M @ 200 (8)	15 M @ 400 (16)		15 M @ 200 (8)	15 M @ 200 (8)	15 M @ 400 (16)
Horizontal Reinforcement	Block height of 12" and 18"	10 M @ 450 (18)	10 M @ 450 (18)	10 M @ 450 (18)	10 M @ 450 (18)	10 M @ 450 (18)	10 M @ 450 (18)	10 M @ 450 (18)	10 M @ 450 (18)
	Block Height of 16"	10 M @ 400 (16)	10 M @ 400 (16)	10 M @ 400 (16)	10 M @ 400 (16)	10 M @ 400 (16)	10 M @ 400 (16)	10 M @ 400 (16)	10 M @ 400 (16)

**NOTES:**

- For highlighted data, where the below grade wall meets all the requirements of NBCC Part 9 for a solid concrete foundation wall and supports only wood frame construction above, a 20MPa unreinforced wall is adequate as per 2020 NBCC table 9.15.4.2.A. Provide the reinforcing shown for walls supporting ICF walls above or with brick veneer supported with the brick ledge form.
- Below grade walls supporting "Drained Earth" in accordance with 2020 NBCC 9.4.4.6 may be designed for an equivalent fluid pressure of 480 kg/m<sup>3</sup>.
- This table is to be used in conjunction with the "Design Limitations" and "Below Grade Reinforcement Placement" drawing.
- Alternating horizontal bar spacing of 12" o.c. and 24" o.c. may be used to achieve an average spacing of 18" o.c. where 18" o.c. spacing is specified for horizontal bars, as shown in Detail A.3.

**Table B.2.2. Continued – Below Grade Wall Distributed Reinforcement for Seismic Zone Classification,  $0.11 < S_{a,ICF} \leq 0.16$  and Hourly Wind Pressure,  $q_{1/50} \leq 1.05kPa$ , for ICF Walls with 8” Tie Spacing**

Wall Height m (ft)	Backfill Height m (ft)	Vertical Steel (Size and Spacing)							
		Backfill Equivalent Fluid Density							
		960 kg/m <sup>3</sup> (60 pcf)				1200 kg/m <sup>3</sup> (75 pcf)			
		150 mm (6") Wall	200 mm (8") Wall	250 mm (10") Wall	300 mm (12") Wall	150 mm (6") Wall	200 mm (8") Wall	250 mm (10") Wall	300 mm (12") Wall
2.44 (8.0)	1.22 (4.0)	15 M @ 400 (16)	10 M @ 400 (16)	10 M @ 400 (16)	10 M @ 400 (16)	15 M @ 400 (16)	10 M @ 400 (16)	10 M @ 400 (16)	10 M @ 400 (16)
	1.53 (5.0)	15 M @ 400 (16)	15 M @ 600 (24)	10 M @ 400 (16)	10 M @ 400 (16)	15 M @ 400 (16)	15 M @ 600 (24)	10 M @ 400 (16)	10 M @ 400 (16)
	1.83 (6.0)	15 M @ 400 (16)	15 M @ 400 (16)	15 M @ 600 (24)	10 M @ 400 (16)	15 M @ 200 (8)	15 M @ 400 (16)	15 M @ 600 (24)	15 M @ 600 (24)
	2.13 (7.0)	15 M @ 200 (8)	15 M @ 400 (16)	15 M @ 400 (16)	15 M @ 600 (24)	15 M @ 200 (8)	15 M @ 400 (16)	15 M @ 400 (16)	15 M @ 600 (24)
	2.44 (8.0)	15 M @ 200 (8)	15 M @ 400 (16)	15 M @ 400 (16)	15 M @ 600 (24)	15 M @ 200 (8)	15 M @ 200 (8)	15 M @ 400 (16)	15 M @ 400 (16)
2.74 (9.0)	1.22 (4.0)	15 M @ 600 (24)	15 M @ 600 (24)	10 M @ 400 (16)	10 M @ 400 (16)	15 M @ 600 (24)	15 M @ 600 (24)	10 M @ 400 (16)	10 M @ 400 (16)
	1.53 (5.0)	15 M @ 400 (16)	15 M @ 600 (24)	10 M @ 400 (16)	10 M @ 400 (16)	15 M @ 400 (16)	15 M @ 600 (24)	10 M @ 400 (16)	10 M @ 400 (16)
	1.83 (6.0)	15 M @ 200 (8)	15 M @ 400 (16)	15 M @ 600 (24)	15 M @ 600 (24)	15 M @ 200 (8)	15 M @ 400 (16)	15 M @ 400 (16)	15 M @ 600 (24)
	2.13 (7.0)	15 M @ 200 (8)	15 M @ 400 (16)	15 M @ 400 (16)	15 M @ 600 (24)	15 M @ 200 (8)	15 M @ 400 (16)	15 M @ 400 (16)	15 M @ 400 (16)
	2.44 (8.0)	15 M @ 200 (8)	15 M @ 200 (8)	15 M @ 400 (16)	15 M @ 400 (16)	15 M @ 200 (8)	15 M @ 200 (8)	15 M @ 400 (16)	15 M @ 400 (16)
	2.74 (9.0)	15 M @ 200 (8)	15 M @ 200 (8)	15 M @ 400 (16)	15 M @ 400 (16)	15 M @ 200 (8)	15 M @ 200 (8)	15 M @ 200 (8)	15 M @ 200 (8)
3.05 (10.0)	1.22 (4.0)	15 M @ 600 (24)	15 M @ 600 (24)	10 M @ 400 (16)	10 M @ 400 (16)	15 M @ 600 (24)	15 M @ 600 (24)	10 M @ 400 (16)	10 M @ 400 (16)
	1.53 (5.0)	15 M @ 400 (16)	15 M @ 600 (24)	10 M @ 400 (16)	10 M @ 400 (16)	15 M @ 400 (16)	15 M @ 600 (24)	15 M @ 600 (24)	10 M @ 400 (16)
	1.83 (6.0)	15 M @ 200 (8)	15 M @ 400 (16)	15 M @ 600 (24)	15 M @ 600 (24)	15 M @ 200 (8)	15 M @ 400 (16)	15 M @ 400 (16)	15 M @ 600 (24)
	2.13 (7.0)	15 M @ 200 (8)	15 M @ 400 (16)	15 M @ 400 (16)	15 M @ 400 (16)	15 M @ 200 (8)	15 M @ 200 (8)	15 M @ 400 (16)	15 M @ 400 (16)
	2.44 (8.0)		15 M @ 200 (8)	15 M @ 400 (16)	15 M @ 400 (16)		15 M @ 200 (8)	15 M @ 200 (8)	15 M @ 400 (16)
	2.74 (9.0)		15 M @ 200 (8)	15 M @ 200 (8)	15 M @ 200 (8)		15 M @ 200 (8)	15 M @ 200 (8)	15 M @ 200 (8)
	3.05 (10.0)		15 M @ 200 (8)	15 M @ 200 (8)	15 M @ 200 (8)		15 M @ 200 (8)	15 M @ 200 (8)	15 M @ 200 (8)
3.35 (11.0)	1.22 (4.0)	15 M @ 600 (24)	15 M @ 600 (24)	10 M @ 400 (16)	10 M @ 400 (16)	15 M @ 600 (24)	15 M @ 600 (24)	10 M @ 400 (16)	10 M @ 400 (16)
	1.53 (5.0)	15 M @ 400 (16)	15 M @ 600 (24)	10 M @ 400 (16)	10 M @ 400 (16)	15 M @ 400 (16)	15 M @ 600 (24)	15 M @ 600 (24)	10 M @ 400 (16)
	1.83 (6.0)	15 M @ 200 (8)	15 M @ 400 (16)	15 M @ 600 (24)	15 M @ 600 (24)	15 M @ 200 (8)	15 M @ 400 (16)	15 M @ 400 (16)	15 M @ 600 (24)
	2.13 (7.0)	15 M @ 200 (8)	15 M @ 200 (8)	15 M @ 400 (16)	15 M @ 400 (16)		15 M @ 200 (8)	15 M @ 400 (16)	15 M @ 400 (16)
	2.44 (8.0)		15 M @ 200 (8)	15 M @ 200 (8)	15 M @ 400 (16)		15 M @ 200 (8)	15 M @ 200 (8)	15 M @ 200 (8)
	2.74 (9.0)		15 M @ 200 (8)	15 M @ 200 (8)	15 M @ 200 (8)		15 M @ 200 (8)	15 M @ 200 (8)	15 M @ 200 (8)
	3.05 (10.0)		15 M @ 200 (8)	15 M @ 200 (8)	15 M @ 200 (8)		15 M @ 200 (8)	15 M @ 200 (8)	15 M @ 200 (8)
	3.35 (11.0)		15 M @ 200 (8)	15 M @ 200 (8)	15 M @ 200 (8)		15 M @ 200 (8)	15 M @ 200 (8)	15 M @ 200 (8)
3.66 (12.0)	1.22 (4.0)	15 M @ 600 (24)	15 M @ 600 (24)	10 M @ 400 (16)	10 M @ 400 (16)	15 M @ 400 (16)	15 M @ 600 (24)	10 M @ 400 (16)	10 M @ 400 (16)
	1.53 (5.0)	15 M @ 400 (16)	15 M @ 600 (24)	15 M @ 600 (24)	10 M @ 400 (16)	15 M @ 400 (16)	15 M @ 400 (16)	15 M @ 600 (24)	10 M @ 400 (16)
	1.83 (6.0)	15 M @ 200 (8)	15 M @ 400 (16)	15 M @ 400 (16)	15 M @ 600 (24)	15 M @ 200 (8)	15 M @ 400 (16)	15 M @ 400 (16)	15 M @ 600 (24)
	2.13 (7.0)		15 M @ 200 (8)	15 M @ 400 (16)	15 M @ 400 (16)		15 M @ 200 (8)	15 M @ 400 (16)	15 M @ 400 (16)
	2.44 (8.0)		15 M @ 200 (8)	15 M @ 200 (8)	15 M @ 400 (16)		15 M @ 200 (8)	15 M @ 200 (8)	15 M @ 200 (8)
	2.74 (9.0)		15 M @ 200 (8)	15 M @ 200 (8)	15 M @ 200 (8)		15 M @ 200 (8)	15 M @ 200 (8)	15 M @ 200 (8)
	3.05 (10.0)			15 M @ 200 (8)	15 M @ 200 (8)			15 M @ 200 (8)	15 M @ 200 (8)
	3.35 (11.0)			15 M @ 200 (8)	15 M @ 200 (8)			15 M @ 200 (8)	15 M @ 200 (8)
	3.66 (12.0)			15 M @ 200 (8)	15 M @ 200 (8)			15 M @ 200 (8)	15 M @ 200 (8)
Horizontal Reinforcement	Block height of 12" and 18"	10 M @ 450 (18)	10 M @ 450 (18)	10 M @ 450 (18)	10 M @ 450 (18)	10 M @ 450 (18)	10 M @ 450 (18)	10 M @ 450 (18)	10 M @ 450 (18)
	Block Height of 16"	10 M @ 400 (16)	10 M @ 400 (16)	10 M @ 400 (16)	10 M @ 400 (16)	10 M @ 400 (16)	10 M @ 400 (16)	10 M @ 400 (16)	10 M @ 400 (16)

**NOTES:**

- For highlighted data, where the below grade wall meets all the requirements of NBCC Part 9 for a solid concrete foundation wall and supports only wood frame construction above, a 20MPa unreinforced wall is adequate as per 2020 NBCC table 9.15.4.2.A. Provide the reinforcing shown for walls supporting ICF walls above or with brick veneer supported with the brick ledge form.
- Below grade walls supporting "Drained Earth" in accordance with 2020 NBCC 9.4.4.6 may be designed for an equivalent fluid pressure of 480 kg/m<sup>3</sup>.
- This table is to be used in conjunction with the "Design Limitations" and "Below Grade Reinforcement Placement" drawing.
- Alternating horizontal bar spacing of 12" o.c. and 24" o.c. may be used to achieve an average spacing of 18" o.c. where 18" o.c. spacing is specified for horizontal bars, as shown in Detail A.3.



**Table B.3.1. – Below Grade Wall Distributed Reinforcement for Seismic Zone Classification,  $0.16 < S_{a,ICF} \leq 0.31$  and Hourly Wind Pressure,  $q_{1/50} \leq 1.05\text{kPa}$ , for ICF Walls with 6" Tie Spacing**

Wall Height m (ft)	Backfill Height m (ft)	Vertical Steel (Size and Spacing)							
		Backfill Equivalent Fluid Density							
		480 kg/m <sup>3</sup> (30 pcf)				720 kg/m <sup>3</sup> (45 pcf)			
		150 mm (6") Wall	200 mm (8") Wall	250 mm (10") Wall	300 mm (12") Wall	150 mm (6") Wall	200 mm (8") Wall	250 mm (10") Wall	300 mm (12") Wall
2.44 (8.0)	1.22 (4.0)	10 M @ 300 (12)	10 M @ 300 (12)	10 M @ 300 (12)	10 M @ 300 (12)	15 M @ 450 (18)	10 M @ 300 (12)	10 M @ 300 (12)	10 M @ 300 (12)
	1.53 (5.0)	15 M @ 450 (18)	10 M @ 300 (12)	10 M @ 300 (12)	10 M @ 300 (12)	15 M @ 450 (18)	10 M @ 300 (12)	10 M @ 300 (12)	10 M @ 300 (12)
	1.83 (6.0)	15 M @ 300 (12)	15 M @ 450 (18)	15 M @ 450 (18)	10 M @ 300 (12)	15 M @ 300 (12)	15 M @ 450 (18)	15 M @ 450 (18)	10 M @ 300 (12)
	2.13 (7.0)	15 M @ 150 (6)	15 M @ 300 (12)	15 M @ 450 (18)	10 M @ 300 (12)	15 M @ 150 (6)	15 M @ 300 (12)	15 M @ 450 (18)	15 M @ 450 (18)
	2.44 (8.0)	15 M @ 150 (6)	15 M @ 300 (12)	15 M @ 450 (18)	15 M @ 450 (18)	15 M @ 150 (6)	15 M @ 300 (12)	15 M @ 300 (12)	15 M @ 450 (18)
2.74 (9.0)	1.22 (4.0)	10 M @ 300 (12)	10 M @ 300 (12)	10 M @ 300 (12)	10 M @ 300 (12)	10 M @ 300 (12)	10 M @ 300 (12)	10 M @ 300 (12)	10 M @ 300 (12)
	1.53 (5.0)	15 M @ 450 (18)	15 M @ 450 (18)	10 M @ 300 (12)	10 M @ 300 (12)	15 M @ 300 (12)	15 M @ 450 (18)	10 M @ 300 (12)	10 M @ 300 (12)
	1.83 (6.0)	15 M @ 300 (12)	15 M @ 450 (18)	15 M @ 450 (18)	10 M @ 300 (12)	15 M @ 150 (6)	15 M @ 300 (12)	15 M @ 450 (18)	10 M @ 300 (12)
	2.13 (7.0)	15 M @ 150 (6)	15 M @ 300 (12)	15 M @ 450 (18)	15 M @ 450 (18)	15 M @ 150 (6)	15 M @ 300 (12)	15 M @ 450 (18)	15 M @ 450 (18)
	2.44 (8.0)	15 M @ 150 (6)	15 M @ 300 (12)	15 M @ 300 (12)	15 M @ 300 (12)	15 M @ 150 (6)	15 M @ 150 (6)	15 M @ 300 (12)	15 M @ 300 (12)
2.74 (9.0)	15 M @ 150 (6)	15 M @ 150 (6)	15 M @ 300 (12)	15 M @ 300 (12)		15 M @ 150 (6)	15 M @ 300 (12)	15 M @ 300 (12)	
3.05 (10.0)	1.22 (4.0)	10 M @ 300 (12)	10 M @ 300 (12)	10 M @ 300 (12)	10 M @ 300 (12)	10 M @ 300 (12)	10 M @ 300 (12)	10 M @ 300 (12)	10 M @ 300 (12)
	1.53 (5.0)	15 M @ 300 (12)	15 M @ 450 (18)	10 M @ 300 (12)	10 M @ 300 (12)	15 M @ 300 (12)	15 M @ 450 (18)	10 M @ 300 (12)	10 M @ 300 (12)
	1.83 (6.0)	15 M @ 150 (6)	15 M @ 300 (12)	15 M @ 450 (18)	10 M @ 300 (12)	15 M @ 150 (6)	15 M @ 300 (12)	15 M @ 450 (18)	15 M @ 450 (18)
	2.13 (7.0)	15 M @ 150 (6)	15 M @ 300 (12)	15 M @ 450 (18)	15 M @ 450 (18)	15 M @ 150 (6)	15 M @ 300 (12)	15 M @ 300 (12)	15 M @ 450 (18)
	2.44 (8.0)	15 M @ 150 (6)	15 M @ 150 (6)	15 M @ 300 (12)	15 M @ 300 (12)	15 M @ 150 (6)	15 M @ 300 (12)	15 M @ 300 (12)	15 M @ 300 (12)
2.74 (9.0)		15 M @ 150 (6)	15 M @ 150 (6)	15 M @ 300 (12)		15 M @ 150 (6)	15 M @ 150 (6)	15 M @ 300 (12)	
3.05 (10.0)		15 M @ 150 (6)	15 M @ 150 (6)	15 M @ 300 (12)		15 M @ 150 (6)	15 M @ 150 (6)	15 M @ 300 (12)	
3.35 (11.0)	1.22 (4.0)	10 M @ 300 (12)	10 M @ 300 (12)	10 M @ 300 (12)	10 M @ 300 (12)	10 M @ 300 (12)	10 M @ 300 (12)	10 M @ 300 (12)	10 M @ 300 (12)
	1.53 (5.0)	15 M @ 300 (12)	15 M @ 450 (18)	10 M @ 300 (12)	10 M @ 300 (12)	15 M @ 300 (12)	15 M @ 450 (18)	10 M @ 300 (12)	10 M @ 300 (12)
	1.83 (6.0)	15 M @ 150 (6)	15 M @ 300 (12)	15 M @ 450 (18)	10 M @ 300 (12)	15 M @ 150 (6)	15 M @ 300 (12)	15 M @ 450 (18)	15 M @ 450 (18)
	2.13 (7.0)	15 M @ 150 (6)	15 M @ 300 (12)	15 M @ 300 (12)	15 M @ 450 (18)	15 M @ 150 (6)	15 M @ 150 (6)	15 M @ 300 (12)	15 M @ 300 (12)
	2.44 (8.0)		15 M @ 150 (6)	15 M @ 300 (12)	15 M @ 300 (12)		15 M @ 150 (6)	15 M @ 150 (6)	15 M @ 300 (12)
2.74 (9.0)		15 M @ 150 (6)	15 M @ 150 (6)	15 M @ 300 (12)		15 M @ 150 (6)	15 M @ 150 (6)	15 M @ 300 (12)	
3.05 (10.0)			15 M @ 150 (6)	15 M @ 150 (6)	15 M @ 300 (12)		15 M @ 150 (6)	15 M @ 150 (6)	
3.35 (11.0)			15 M @ 150 (6)	15 M @ 150 (6)	15 M @ 150 (6)		15 M @ 150 (6)	15 M @ 150 (6)	
3.66 (12.0)	1.22 (4.0)	10 M @ 300 (12)	10 M @ 300 (12)	10 M @ 300 (12)	10 M @ 300 (12)	10 M @ 300 (12)	10 M @ 300 (12)	10 M @ 300 (12)	10 M @ 300 (12)
	1.53 (5.0)	15 M @ 300 (12)	15 M @ 450 (18)	10 M @ 300 (12)	10 M @ 300 (12)	15 M @ 300 (12)	15 M @ 450 (18)	10 M @ 300 (12)	10 M @ 300 (12)
	1.83 (6.0)	15 M @ 150 (6)	15 M @ 300 (12)	15 M @ 450 (18)	15 M @ 450 (18)	15 M @ 150 (6)	15 M @ 300 (12)	15 M @ 450 (18)	15 M @ 450 (18)
	2.13 (7.0)	15 M @ 150 (6)	15 M @ 150 (6)	15 M @ 300 (12)	15 M @ 300 (12)	15 M @ 150 (6)	15 M @ 300 (12)	15 M @ 300 (12)	15 M @ 300 (12)
	2.44 (8.0)		15 M @ 150 (6)	15 M @ 150 (6)	15 M @ 300 (12)		15 M @ 150 (6)	15 M @ 150 (6)	15 M @ 300 (12)
2.74 (9.0)		15 M @ 150 (6)	15 M @ 150 (6)	15 M @ 150 (6)		15 M @ 150 (6)	15 M @ 150 (6)	15 M @ 150 (6)	
3.05 (10.0)			15 M @ 150 (6)	15 M @ 150 (6)			15 M @ 150 (6)	15 M @ 150 (6)	
3.35 (11.0)			15 M @ 150 (6)	15 M @ 150 (6)	15 M @ 150 (6)		15 M @ 150 (6)	15 M @ 150 (6)	
3.66 (12.0)			15 M @ 150 (6)	15 M @ 150 (6)	15 M @ 150 (6)		15 M @ 150 (6)	15 M @ 150 (6)	
Horizontal Reinforcement	Block height of 12" and 18"	10 M @ 450 (18)	10 M @ 450 (18)	10 M @ 450 (18)	10 M @ 450 (18)	10 M @ 450 (18)	10 M @ 450 (18)	10 M @ 450 (18)	10 M @ 450 (18)
	Block Height of 16"	10 M @ 400 (16)	10 M @ 400 (16)	10 M @ 400 (16)	10 M @ 400 (16)	10 M @ 400 (16)	10 M @ 400 (16)	10 M @ 400 (16)	10 M @ 400 (16)

**NOTES:**

- For highlighted data, where the below grade wall meets all the requirements of NBCC Part 9 for a solid concrete foundation wall and supports only wood frame construction above, a 20MPa unreinforced wall is adequate as per 2020 NBCC table 9.15.4.2.A. Provide the reinforcing shown for walls supporting ICF walls above or with brick veneer supported with the brick ledge form.
- Below grade walls supporting "Drained Earth" in accordance with 2020 NBCC 9.4.4.6 may be designed for an equivalent fluid pressure of 480 kg/m<sup>3</sup>.
- This table is to be used in conjunction with the "Design Limitations" and "Below Grade Reinforcement Placement" drawing.
- Provide 3 horizontal bars in every two rows of 18" high block to achieve an average spacing of 12" o.c. where 12" spacing o.c. is specified for horizontal bars, as shown in Detail A.4.
- Provide 4 horizontal bars in every three rows of 16" high block to achieve an average spacing of 12" o.c. where 12" spacing o.c. is specified for horizontal bars, as shown in Detail A.5.

**Table B.3.1. Continued – Below Grade Wall Distributed Reinforcement for Seismic Zone Classification,  $0.16 < S_{a,ICF} \leq 0.31$  and Hourly Wind Pressure,  $q_{1/50} \leq 1.05\text{kPa}$ , for ICF Walls with 6" Tie Spacing**

Wall Height m (ft)	Backfill Height m (ft)	Vertical Steel (Size and Spacing)							
		Backfill Equivalent Fluid Density							
		960 kg/m <sup>3</sup> (60 pcf)				1200 kg/m <sup>3</sup> (75 pcf)			
		150 mm (6") Wall	200 mm (8") Wall	250 mm (10") Wall	300 mm (12") Wall	150 mm (6") Wall	200 mm (8") Wall	250 mm (10") Wall	300 mm (12") Wall
2.44 (8.0)	1.22 (4.0)	15 M @ 450 (18)	10 M @ 300 (12)	10 M @ 300 (12)	10 M @ 300 (12)	15 M @ 450 (18)	10 M @ 300 (12)	10 M @ 300 (12)	10 M @ 300 (12)
	1.53 (5.0)	15 M @ 300 (12)	15 M @ 450 (18)	10 M @ 300 (12)	10 M @ 300 (12)	15 M @ 300 (12)	15 M @ 450 (18)	10 M @ 300 (12)	10 M @ 300 (12)
	1.83 (6.0)	15 M @ 150 (6)	15 M @ 450 (18)	15 M @ 450 (18)	10 M @ 300 (12)	15 M @ 150 (6)	15 M @ 300 (12)	15 M @ 450 (18)	10 M @ 300 (12)
	2.13 (7.0)	15 M @ 150 (6)	15 M @ 300 (12)	15 M @ 450 (18)	15 M @ 450 (18)	15 M @ 150 (6)	15 M @ 300 (12)	15 M @ 450 (18)	15 M @ 450 (18)
	2.44 (8.0)	15 M @ 150 (6)	15 M @ 300 (12)	15 M @ 300 (12)	15 M @ 300 (12)	15 M @ 150 (6)	15 M @ 150 (6)	15 M @ 300 (12)	15 M @ 300 (12)
2.74 (9.0)	1.22 (4.0)	10 M @ 300 (12)	10 M @ 300 (12)	10 M @ 450 (18)	10 M @ 300 (12)	10 M @ 300 (12)	10 M @ 300 (12)	10 M @ 300 (12)	10 M @ 300 (12)
	1.53 (5.0)	15 M @ 300 (12)	15 M @ 450 (18)	10 M @ 300 (12)	10 M @ 300 (12)	15 M @ 300 (12)	15 M @ 450 (18)	10 M @ 300 (12)	10 M @ 300 (12)
	1.83 (6.0)	15 M @ 150 (6)	15 M @ 300 (12)	15 M @ 450 (18)	15 M @ 450 (18)	15 M @ 150 (6)	15 M @ 300 (12)	15 M @ 450 (18)	15 M @ 450 (18)
	2.13 (7.0)	15 M @ 150 (6)	15 M @ 300 (12)	15 M @ 300 (12)	15 M @ 450 (18)	15 M @ 150 (6)	15 M @ 300 (12)	15 M @ 300 (12)	15 M @ 300 (12)
	2.44 (8.0)		15 M @ 150 (6)	15 M @ 300 (12)	15 M @ 300 (12)		15 M @ 150 (6)	15 M @ 300 (12)	15 M @ 300 (12)
3.05 (10.0)	1.22 (4.0)	10 M @ 300 (12)	10 M @ 300 (12)	10 M @ 300 (12)	10 M @ 300 (12)	10 M @ 300 (12)	10 M @ 300 (12)	10 M @ 300 (12)	10 M @ 300 (12)
	1.53 (5.0)	15 M @ 300 (12)	15 M @ 450 (18)	10 M @ 300 (12)	10 M @ 300 (12)	15 M @ 300 (12)	15 M @ 450 (18)	10 M @ 300 (12)	10 M @ 300 (12)
	1.83 (6.0)	15 M @ 150 (6)	15 M @ 300 (12)	15 M @ 450 (18)	15 M @ 450 (18)	15 M @ 150 (6)	15 M @ 300 (12)	15 M @ 450 (18)	15 M @ 450 (18)
	2.13 (7.0)	15 M @ 150 (6)	15 M @ 150 (6)	15 M @ 300 (12)	15 M @ 300 (12)	15 M @ 150 (6)	15 M @ 300 (12)	15 M @ 300 (12)	15 M @ 300 (12)
	2.44 (8.0)		15 M @ 150 (6)	15 M @ 150 (6)	15 M @ 300 (12)		15 M @ 150 (6)	15 M @ 150 (6)	15 M @ 300 (12)
3.35 (11.0)	1.22 (4.0)	10 M @ 300 (12)	10 M @ 300 (12)	10 M @ 300 (12)	10 M @ 300 (12)	10 M @ 300 (12)	10 M @ 300 (12)	10 M @ 300 (12)	10 M @ 300 (12)
	1.53 (5.0)	15 M @ 300 (12)	15 M @ 450 (18)	10 M @ 300 (12)	10 M @ 300 (12)	15 M @ 300 (12)	15 M @ 450 (18)	15 M @ 450 (18)	10 M @ 300 (12)
	1.83 (6.0)	15 M @ 150 (6)	15 M @ 300 (12)	15 M @ 450 (18)	15 M @ 450 (18)	15 M @ 150 (6)	15 M @ 300 (12)	15 M @ 450 (18)	15 M @ 450 (18)
	2.13 (7.0)	15 M @ 150 (6)	15 M @ 150 (6)	15 M @ 300 (12)	15 M @ 300 (12)	15 M @ 150 (6)	15 M @ 300 (12)	15 M @ 300 (12)	15 M @ 300 (12)
	2.44 (8.0)		15 M @ 150 (6)	15 M @ 150 (6)	15 M @ 300 (12)		15 M @ 150 (6)	15 M @ 150 (6)	15 M @ 300 (12)
3.66 (12.0)	1.22 (4.0)	10 M @ 300 (12)	10 M @ 300 (12)	10 M @ 300 (12)	10 M @ 300 (12)	10 M @ 300 (12)	10 M @ 300 (12)	10 M @ 300 (12)	10 M @ 300 (12)
	1.53 (5.0)	15 M @ 300 (12)	15 M @ 450 (18)	10 M @ 300 (12)	10 M @ 300 (12)	15 M @ 300 (12)	15 M @ 450 (18)	15 M @ 450 (18)	10 M @ 300 (12)
	1.83 (6.0)	15 M @ 150 (6)	15 M @ 300 (12)	15 M @ 300 (12)	15 M @ 450 (18)	15 M @ 150 (6)	15 M @ 300 (12)	15 M @ 300 (12)	15 M @ 450 (18)
	2.13 (7.0)		15 M @ 150 (6)	15 M @ 300 (12)	15 M @ 300 (12)		15 M @ 150 (6)	15 M @ 300 (12)	15 M @ 300 (12)
	2.44 (8.0)		15 M @ 150 (6)	15 M @ 150 (6)	15 M @ 300 (12)		15 M @ 150 (6)	15 M @ 150 (6)	15 M @ 150 (6)
Horizontal Reinforcement	Block height of 12" and 18"	10 M @ 450 (18)	10 M @ 450 (18)	10 M @ 450 (18)	10 M @ 450 (18)	10 M @ 450 (18)	10 M @ 450 (18)	10 M @ 450 (18)	10 M @ 450 (18)
	Block Height of 16"	10 M @ 400 (16)	10 M @ 400 (16)	10 M @ 400 (16)	10 M @ 400 (16)	10 M @ 400 (16)	10 M @ 400 (16)	10 M @ 400 (16)	10 M @ 400 (16)

NOTES:

- For highlighted data, where the below grade wall meets all the requirements of NBCC Part 9 for a solid concrete foundation wall and supports only wood frame construction above, a 20MPa unreinforced wall is adequate as per 2020 NBCC table 9.15.4.2.A. Provide the reinforcing shown for walls supporting ICF walls above or with brick veneer supported with the brick ledge form.
- Below grade walls supporting "Drained Earth" in accordance with 2020 NBCC 9.4.4.6 may be designed for an equivalent fluid pressure of 480 kg/m<sup>3</sup>.
- This table is to be used in conjunction with the "Design Limitations" and "Below Grade Reinforcement Placement" drawing.
- Provide 3 horizontal bars in every two rows of 18" high block to achieve an average spacing of 12" o.c. where 12" spacing o.c. is specified for horizontal bars, as shown in Detail A.4.
- Provide 4 horizontal bars in every three rows of 16" high block to achieve an average spacing of 12" o.c. where 12" spacing o.c. is specified for horizontal bars, as shown in Detail A.5.

**Table B.3.2. – Below Grade Wall Distributed Reinforcement for Seismic Zone Classification, 0.16 <  $S_{a,ICF} \leq 0.31$  and Hourly Wind Pressure,  $q_{1/50} \leq 1.05\text{kPa}$ , for ICF Walls with 8" Tie Spacing**

Wall Height m (ft)	Backfill Height m (ft)	Vertical Steel (Size and Spacing)							
		Backfill Equivalent Fluid Density							
		480 kg/m <sup>3</sup> (30 pcf)				720 kg/m <sup>3</sup> (45 pcf)			
		150 mm (6") Wall	200 mm (8") Wall	250 mm (10") Wall	300 mm (12") Wall	150 mm (6") Wall	200 mm (8") Wall	250 mm (10") Wall	300 mm (12") Wall
2.44 (8.0)	1.22 (4.0)	10 M @ 200 (8)	10 M @ 400 (16)	10 M @ 400 (16)	10 M @ 400 (16)	15 M @ 400 (16)	10 M @ 400 (16)	10 M @ 400 (16)	10 M @ 400 (16)
	1.53 (5.0)	15 M @ 400 (16)	10 M @ 200 (8)	10 M @ 400 (16)	10 M @ 400 (16)	15 M @ 400 (16)	10 M @ 200 (8)	10 M @ 400 (16)	10 M @ 400 (16)
	1.83 (6.0)	15 M @ 200 (8)	15 M @ 400 (16)	15 M @ 400 (16)	10 M @ 400 (16)	15 M @ 200 (8)	15 M @ 400 (16)	15 M @ 400 (16)	10 M @ 200 (8)
	2.13 (7.0)	15 M @ 200 (8)	15 M @ 400 (16)	15 M @ 400 (16)	10 M @ 400 (16)	15 M @ 200 (8)	15 M @ 400 (16)	15 M @ 400 (16)	15 M @ 400 (16)
	2.44 (8.0)	15 M @ 200 (8)	15 M @ 200 (8)	15 M @ 400 (16)	15 M @ 400 (16)	15 M @ 200 (8)	15 M @ 200 (8)	15 M @ 400 (16)	15 M @ 400 (16)
2.74 (9.0)	1.22 (4.0)	10 M @ 200 (8)	10 M @ 400 (16)	10 M @ 400 (16)	10 M @ 400 (16)	10 M @ 200 (8)	10 M @ 400 (16)	10 M @ 400 (16)	10 M @ 400 (16)
	1.53 (5.0)	15 M @ 400 (16)	15 M @ 400 (16)	10 M @ 400 (16)	10 M @ 400 (16)	15 M @ 400 (16)	15 M @ 400 (16)	10 M @ 200 (8)	10 M @ 400 (16)
	1.83 (6.0)	15 M @ 200 (8)	15 M @ 400 (16)	15 M @ 400 (16)	10 M @ 200 (8)	15 M @ 200 (8)	15 M @ 400 (16)	15 M @ 400 (16)	10 M @ 200 (8)
	2.13 (7.0)	15 M @ 200 (8)	15 M @ 200 (8)	15 M @ 400 (16)	15 M @ 400 (16)	15 M @ 200 (8)	15 M @ 200 (8)	15 M @ 400 (16)	15 M @ 400 (16)
	2.44 (8.0)	15 M @ 200 (8)	15 M @ 200 (8)	15 M @ 400 (16)	15 M @ 400 (16)	15 M @ 200 (8)	15 M @ 200 (8)	15 M @ 200 (8)	15 M @ 400 (16)
2.74 (9.0)		15 M @ 200 (8)	15 M @ 200 (8)	15 M @ 200 (8)		15 M @ 200 (8)	15 M @ 200 (8)	15 M @ 200 (8)	
3.05 (10.0)	1.22 (4.0)	10 M @ 200 (8)	10 M @ 400 (16)	10 M @ 400 (16)	10 M @ 400 (16)	10 M @ 200 (8)	10 M @ 400 (16)	10 M @ 400 (16)	10 M @ 400 (16)
	1.53 (5.0)	15 M @ 400 (16)	15 M @ 400 (16)	10 M @ 200 (8)	10 M @ 400 (16)	15 M @ 200 (8)	15 M @ 400 (16)	10 M @ 200 (8)	10 M @ 400 (16)
	1.83 (6.0)	15 M @ 200 (8)	15 M @ 400 (16)	15 M @ 400 (16)	10 M @ 200 (8)	15 M @ 200 (8)	15 M @ 400 (16)	15 M @ 400 (16)	15 M @ 400 (16)
	2.13 (7.0)	15 M @ 200 (8)	15 M @ 200 (8)	15 M @ 400 (16)	15 M @ 400 (16)		15 M @ 200 (8)	15 M @ 400 (16)	15 M @ 400 (16)
	2.44 (8.0)		15 M @ 200 (8)	15 M @ 200 (8)	15 M @ 200 (8)		15 M @ 200 (8)	15 M @ 200 (8)	15 M @ 200 (8)
2.74 (9.0)		15 M @ 200 (8)	15 M @ 200 (8)	15 M @ 200 (8)		15 M @ 200 (8)	15 M @ 200 (8)	15 M @ 200 (8)	
3.05 (10.0)			15 M @ 200 (8)	15 M @ 200 (8)			15 M @ 200 (8)	15 M @ 200 (8)	
3.35 (11.0)	1.22 (4.0)	10 M @ 200 (8)	10 M @ 400 (16)	10 M @ 400 (16)	10 M @ 400 (16)	10 M @ 200 (8)	10 M @ 400 (16)	10 M @ 400 (16)	10 M @ 400 (16)
	1.53 (5.0)	15 M @ 400 (16)	15 M @ 400 (16)	10 M @ 200 (8)	10 M @ 400 (16)	15 M @ 200 (8)	15 M @ 400 (16)	10 M @ 200 (8)	10 M @ 400 (16)
	1.83 (6.0)	15 M @ 200 (8)	15 M @ 400 (16)	15 M @ 400 (16)	10 M @ 200 (8)	15 M @ 200 (8)	15 M @ 400 (16)	15 M @ 400 (16)	15 M @ 400 (16)
	2.13 (7.0)		15 M @ 200 (8)	15 M @ 400 (16)	15 M @ 400 (16)		15 M @ 200 (8)	15 M @ 200 (8)	15 M @ 400 (16)
	2.44 (8.0)		15 M @ 200 (8)	15 M @ 200 (8)	15 M @ 200 (8)		15 M @ 200 (8)	15 M @ 200 (8)	15 M @ 200 (8)
2.74 (9.0)			15 M @ 200 (8)	15 M @ 200 (8)		15 M @ 200 (8)	15 M @ 200 (8)	15 M @ 200 (8)	
3.05 (10.0)			15 M @ 200 (8)	15 M @ 200 (8)			15 M @ 200 (8)	15 M @ 200 (8)	
3.35 (11.0)				15 M @ 200 (8)			15 M @ 200 (8)	15 M @ 200 (8)	
3.66 (12.0)	1.22 (4.0)	10 M @ 200 (8)	10 M @ 400 (16)	10 M @ 400 (16)	10 M @ 400 (16)	10 M @ 200 (8)	10 M @ 400 (16)	10 M @ 400 (16)	10 M @ 400 (16)
	1.53 (5.0)	15 M @ 200 (8)	15 M @ 400 (16)	10 M @ 200 (8)	10 M @ 400 (16)	15 M @ 200 (8)	15 M @ 400 (16)	10 M @ 200 (8)	10 M @ 400 (16)
	1.83 (6.0)	15 M @ 200 (8)	15 M @ 400 (16)	15 M @ 400 (16)	15 M @ 400 (16)	15 M @ 200 (8)	15 M @ 200 (8)	15 M @ 400 (16)	15 M @ 400 (16)
	2.13 (7.0)		15 M @ 200 (8)	15 M @ 200 (8)	15 M @ 400 (16)		15 M @ 200 (8)	15 M @ 200 (8)	15 M @ 200 (8)
	2.44 (8.0)		15 M @ 200 (8)	15 M @ 200 (8)	15 M @ 200 (8)		15 M @ 200 (8)	15 M @ 200 (8)	15 M @ 200 (8)
2.74 (9.0)			15 M @ 200 (8)	15 M @ 200 (8)			15 M @ 200 (8)	15 M @ 200 (8)	
3.05 (10.0)			15 M @ 200 (8)	15 M @ 200 (8)			15 M @ 200 (8)	15 M @ 200 (8)	
3.35 (11.0)				15 M @ 200 (8)			15 M @ 200 (8)	15 M @ 200 (8)	
3.66 (12.0)				15 M @ 200 (8)			15 M @ 200 (8)	15 M @ 200 (8)	
Horizontal Reinforcement	Block height of 12" and 18"	10 M @ 450 (18)	10 M @ 450 (18)	10 M @ 450 (18)	10 M @ 450 (18)	10 M @ 450 (18)	10 M @ 450 (18)	10 M @ 450 (18)	10 M @ 450 (18)
	Block Height of 16"	10 M @ 400 (16)	10 M @ 400 (16)	10 M @ 400 (16)	10 M @ 400 (16)	10 M @ 400 (16)	10 M @ 400 (16)	10 M @ 400 (16)	10 M @ 400 (16)

**NOTES:**

- For highlighted data, where the below grade wall meets all the requirements of NBCC Part 9 for a solid concrete foundation wall and supports only wood frame construction above, a 20MPa unreinforced wall is adequate as per 2020 NBCC table 9.15.4.2.A. Provide the reinforcing shown for walls supporting ICF walls above or with brick veneer supported with the brick ledge form.
- Below grade walls supporting "Drained Earth" in accordance with 2020 NBCC 9.4.4.6 may be designed for an equivalent fluid pressure of 480 kg/m<sup>3</sup>.
- This table is to be used in conjunction with the "Design Limitations" and "Below Grade Reinforcement Placement" drawing.
- Provide 3 horizontal bars in every two rows of 18" high block to achieve an average spacing of 12" o.c. where 12" spacing o.c. is specified for horizontal bars, as shown in Detail A.4.
- Provide 4 horizontal bars in every three rows of 16" high block to achieve an average spacing of 12" o.c. where 12" spacing o.c. is specified for horizontal bars, as shown in Detail A.5.

**Table B.3.2. Continued– Below Grade Wall Distributed Reinforcement for Seismic Zone Classification,  $0.16 < S_{a,ICF} \leq 0.31$  and Hourly Wind Pressure,  $q_{1/50} \leq 1.05kPa$ , for ICF Walls with 8” Tie Spacing**

Wall Height m (ft)	Backfill Height m (ft)	Vertical Steel (Size and Spacing)							
		Backfill Equivalent Fluid Density							
		960 kg/m <sup>3</sup> (60 pcf)				1200 kg/m <sup>3</sup> (75 pcf)			
		150 mm (6") Wall	200 mm (8") Wall	250 mm (10") Wall	300 mm (12") Wall	150 mm (6") Wall	200 mm (8") Wall	250 mm (10") Wall	300 mm (12") Wall
2.44 (8.0)	1.22 (4.0)	15 M @ 400 (16)	10 M @ 400 (16)	10 M @ 400 (16)	10 M @ 400 (16)	15 M @ 400 (16)	10 M @ 400 (16)	10 M @ 400 (16)	10 M @ 400 (16)
	1.53 (5.0)	15 M @ 400 (16)	15 M @ 400 (16)	10 M @ 400 (16)	10 M @ 400 (16)	15 M @ 400 (16)	15 M @ 400 (16)	10 M @ 200 (8)	10 M @ 400 (16)
	1.83 (6.0)	15 M @ 200 (8)	15 M @ 400 (16)	15 M @ 400 (16)	10 M @ 200 (8)	15 M @ 200 (8)	15 M @ 400 (16)	15 M @ 400 (16)	10 M @ 200 (8)
	2.13 (7.0)	15 M @ 200 (8)	15 M @ 200 (8)	15 M @ 400 (16)	15 M @ 400 (16)	15 M @ 200 (8)	15 M @ 200 (8)	15 M @ 400 (16)	15 M @ 400 (16)
	2.44 (8.0)		15 M @ 200 (8)	15 M @ 400 (16)	15 M @ 400 (16)		15 M @ 200 (8)	15 M @ 200 (8)	15 M @ 200 (8)
2.74 (9.0)	1.22 (4.0)	10 M @ 200 (8)	10 M @ 400 (16)	10 M @ 400 (16)	10 M @ 400 (16)	10 M @ 200 (8)	10 M @ 400 (16)	10 M @ 400 (16)	10 M @ 400 (16)
	1.53 (5.0)	15 M @ 200 (8)	15 M @ 400 (16)	10 M @ 200 (8)	10 M @ 200 (8)	15 M @ 200 (8)	15 M @ 400 (16)	10 M @ 200 (8)	10 M @ 400 (16)
	1.83 (6.0)	15 M @ 200 (8)	15 M @ 400 (16)	15 M @ 400 (16)	15 M @ 400 (16)	15 M @ 200 (8)	15 M @ 400 (16)	15 M @ 400 (16)	15 M @ 400 (16)
	2.13 (7.0)		15 M @ 200 (8)	15 M @ 400 (16)	15 M @ 400 (16)		15 M @ 200 (8)	15 M @ 400 (16)	15 M @ 400 (16)
	2.44 (8.0)		15 M @ 200 (8)	15 M @ 200 (8)	15 M @ 200 (8)		15 M @ 200 (8)	15 M @ 200 (8)	15 M @ 200 (8)
	2.74 (9.0)		15 M @ 200 (8)	15 M @ 200 (8)	15 M @ 200 (8)		15 M @ 200 (8)	15 M @ 200 (8)	15 M @ 200 (8)
3.05 (10.0)	1.22 (4.0)	10 M @ 200 (8)	10 M @ 400 (16)	10 M @ 400 (16)	10 M @ 400 (16)	10 M @ 200 (8)	10 M @ 400 (16)	10 M @ 400 (16)	10 M @ 400 (16)
	1.53 (5.0)	15 M @ 200 (8)	15 M @ 400 (16)	10 M @ 200 (8)	10 M @ 400 (16)	15 M @ 200 (8)	15 M @ 400 (16)	10 M @ 200 (8)	10 M @ 400 (16)
	1.83 (6.0)	15 M @ 200 (8)	15 M @ 400 (16)	15 M @ 400 (16)	15 M @ 400 (16)	15 M @ 200 (8)	15 M @ 400 (16)	15 M @ 400 (16)	15 M @ 400 (16)
	2.13 (7.0)		15 M @ 200 (8)	15 M @ 200 (8)	15 M @ 400 (16)		15 M @ 200 (8)	15 M @ 200 (8)	15 M @ 200 (8)
	2.44 (8.0)		15 M @ 200 (8)	15 M @ 200 (8)	15 M @ 200 (8)		15 M @ 200 (8)	15 M @ 200 (8)	15 M @ 200 (8)
	2.74 (9.0)		15 M @ 200 (8)	15 M @ 200 (8)	15 M @ 200 (8)		15 M @ 200 (8)	15 M @ 200 (8)	15 M @ 200 (8)
	3.05 (10.0)			15 M @ 200 (8)	15 M @ 200 (8)			15 M @ 200 (8)	15 M @ 200 (8)
3.35 (11.0)	1.22 (4.0)	10 M @ 200 (8)	10 M @ 400 (16)	10 M @ 400 (16)	10 M @ 400 (16)	10 M @ 200 (8)	10 M @ 400 (16)	10 M @ 400 (16)	10 M @ 400 (16)
	1.53 (5.0)	15 M @ 200 (8)	15 M @ 400 (16)	10 M @ 200 (8)	10 M @ 200 (8)	15 M @ 200 (8)	15 M @ 400 (16)	15 M @ 400 (16)	10 M @ 400 (16)
	1.83 (6.0)	15 M @ 200 (8)	15 M @ 400 (16)	15 M @ 400 (16)	15 M @ 400 (16)		15 M @ 200 (8)	15 M @ 400 (16)	15 M @ 400 (16)
	2.13 (7.0)		15 M @ 200 (8)	15 M @ 200 (8)	15 M @ 200 (8)		15 M @ 200 (8)	15 M @ 200 (8)	15 M @ 200 (8)
	2.44 (8.0)			15 M @ 200 (8)	15 M @ 200 (8)			15 M @ 200 (8)	15 M @ 200 (8)
	2.74 (9.0)			15 M @ 200 (8)	15 M @ 200 (8)			15 M @ 200 (8)	15 M @ 200 (8)
	3.05 (10.0)			15 M @ 200 (8)	15 M @ 200 (8)			15 M @ 200 (8)	15 M @ 200 (8)
	3.35 (11.0)				15 M @ 200 (8)				15 M @ 200 (8)
3.66 (12.0)	1.22 (4.0)	10 M @ 200 (8)	10 M @ 400 (16)	10 M @ 400 (16)	10 M @ 400 (16)	10 M @ 200 (8)	10 M @ 200 (8)	10 M @ 400 (16)	10 M @ 400 (16)
	1.53 (5.0)	15 M @ 200 (8)	15 M @ 400 (16)	10 M @ 200 (8)	10 M @ 400 (16)	15 M @ 200 (8)	15 M @ 400 (16)	15 M @ 400 (16)	10 M @ 200 (8)
	1.83 (6.0)		15 M @ 200 (8)	15 M @ 400 (16)	15 M @ 400 (16)		15 M @ 200 (8)	15 M @ 400 (16)	15 M @ 400 (16)
	2.13 (7.0)		15 M @ 200 (8)	15 M @ 200 (8)	15 M @ 200 (8)		15 M @ 200 (8)	15 M @ 200 (8)	15 M @ 200 (8)
	2.44 (8.0)			15 M @ 200 (8)	15 M @ 200 (8)		15 M @ 200 (8)	15 M @ 200 (8)	15 M @ 200 (8)
	2.74 (9.0)				15 M @ 200 (8)			15 M @ 200 (8)	15 M @ 200 (8)
	3.05 (10.0)				15 M @ 200 (8)				15 M @ 200 (8)
	3.35 (11.0)				15 M @ 200 (8)				15 M @ 200 (8)
	3.66 (12.0)								15 M @ 200 (8)
Horizontal Reinforcement	Block height of 12" and 18"	10 M @ 450 (18)	10 M @ 450 (18)	10 M @ 450 (18)	10 M @ 450 (18)	10 M @ 450 (18)	10 M @ 450 (18)	10 M @ 450 (18)	10 M @ 450 (18)
	Block Height of 16"	10 M @ 400 (16)	10 M @ 400 (16)	10 M @ 400 (16)	10 M @ 400 (16)	10 M @ 400 (16)	10 M @ 400 (16)	10 M @ 400 (16)	10 M @ 400 (16)

**NOTES:**

- For highlighted data, where the below grade wall meets all the requirements of NBCC Part 9 for a solid concrete foundation wall and supports only wood frame construction above, a 20MPa unreinforced wall is adequate as per 2020 NBCC table 9.15.4.2.A. Provide the reinforcing shown for walls supporting ICF walls above or with brick veneer supported with the brick ledge form.
- Below grade walls supporting "Drained Earth" in accordance with 2020 NBCC 9.4.4.6 may be designed for an equivalent fluid pressure of 480 kg/m<sup>3</sup>.
- This table is to be used in conjunction with the "Design Limitations" and "Below Grade Reinforcement Placement" drawing.
- Provide 3 horizontal bars in every two rows of 18" high block to achieve an average spacing of 12" o.c. where 12" spacing o.c. is specified for horizontal bars, as shown in Detail A.4.
- Provide 4 horizontal bars in every three rows of 16" high block to achieve an average spacing of 12" o.c. where 12" spacing o.c. is specified for horizontal bars, as shown in Detail A.5.

**Table B.4.1. – Below Grade Wall Distributed Reinforcement for Seismic Zone Classification,  $0.31 < S_{a,ICF} \leq 0.79$  and Hourly Wind Pressure,  $q_1/50 \leq 1.05kPa$ , for ICF Walls with 6" Tie Spacing**

Wall Height m (ft)	Backfill Height m (ft)	Vertical Steel (Size and Spacing)							
		Backfill Equivalent Fluid Density							
		480 kg/m <sup>3</sup> (30 pcf)				720 kg/m <sup>3</sup> (45 pcf)			
		150 mm (6") Wall	200 mm (8") Wall	250 mm (10") Wall	300 mm (12") Wall	150 mm (6") Wall	200 mm (8") Wall	250 mm (10") Wall	300 mm (12") Wall
2.44 (8.0)	1.22 (4.0)	15 M @ 300 (12)	15 M @ 450 (18)	10 M @ 300 (12)	10 M @ 300 (12)	15 M @ 450 (18)	15 M @ 450 (18)	10 M @ 300 (12)	10 M @ 300 (12)
	1.53 (5.0)	15 M @ 300 (12)	15 M @ 450 (18)	15 M @ 450 (18)	15 M @ 450 (18)	15 M @ 150 (6)	15 M @ 450 (18)	15 M @ 450 (18)	15 M @ 450 (18)
	1.83 (6.0)	15 M @ 150 (6)	15 M @ 300 (12)	15 M @ 450 (18)	15 M @ 300 (12)	15 M @ 150 (6)	15 M @ 300 (12)	15 M @ 300 (12)	15 M @ 300 (12)
	2.13 (7.0)	15 M @ 150 (6)	15 M @ 150 (6)	15 M @ 300 (12)	15 M @ 300 (12)	15 M @ 150 (6)	15 M @ 150 (6)	15 M @ 300 (12)	15 M @ 300 (12)
	2.44 (8.0)		15 M @ 150 (6)	15 M @ 300 (12)	15 M @ 300 (12)	15 M @ 150 (6)	15 M @ 150 (6)	15 M @ 150 (6)	15 M @ 300 (12)
2.74 (9.0)	1.22 (4.0)	15 M @ 450 (18)	15 M @ 450 (18)	10 M @ 300 (12)	10 M @ 300 (12)	15 M @ 450 (18)	15 M @ 450 (18)	10 M @ 300 (12)	10 M @ 300 (12)
	1.53 (5.0)	15 M @ 150 (6)	15 M @ 300 (12)	15 M @ 450 (18)	15 M @ 450 (18)	15 M @ 150 (6)	15 M @ 300 (12)	15 M @ 450 (18)	15 M @ 450 (18)
	1.83 (6.0)	15 M @ 150 (6)	15 M @ 300 (12)	15 M @ 300 (12)	15 M @ 300 (12)	15 M @ 150 (6)	15 M @ 150 (6)	15 M @ 300 (12)	15 M @ 300 (12)
	2.13 (7.0)		15 M @ 150 (6)	15 M @ 300 (12)	15 M @ 300 (12)	15 M @ 150 (6)	15 M @ 150 (6)	15 M @ 150 (6)	15 M @ 300 (12)
	2.44 (8.0)		15 M @ 150 (6)	15 M @ 150 (6)	15 M @ 150 (6)		15 M @ 150 (6)	15 M @ 150 (6)	15 M @ 150 (6)
3.05 (10.0)	1.22 (4.0)	15 M @ 300 (12)	15 M @ 450 (18)	10 M @ 300 (12)	10 M @ 300 (12)	15 M @ 300 (12)	15 M @ 450 (18)	10 M @ 300 (12)	10 M @ 300 (12)
	1.53 (5.0)	15 M @ 150 (6)	15 M @ 300 (12)	15 M @ 450 (18)	15 M @ 450 (18)	15 M @ 150 (6)	15 M @ 300 (12)	15 M @ 450 (18)	15 M @ 300 (12)
	1.83 (6.0)	15 M @ 150 (6)	15 M @ 150 (6)	15 M @ 300 (12)	15 M @ 300 (12)	15 M @ 150 (6)	15 M @ 150 (6)	15 M @ 300 (12)	15 M @ 300 (12)
	2.13 (7.0)		15 M @ 150 (6)	15 M @ 150 (6)	15 M @ 300 (12)	15 M @ 150 (6)	15 M @ 150 (6)	15 M @ 150 (6)	15 M @ 150 (6)
	2.44 (8.0)		15 M @ 150 (6)	15 M @ 150 (6)	15 M @ 150 (6)			15 M @ 150 (6)	15 M @ 150 (6)
3.35 (11.0)	1.22 (4.0)	15 M @ 300 (12)	10 M @ 300 (12)	10 M @ 300 (12)	10 M @ 300 (12)	15 M @ 300 (12)	15 M @ 450 (18)	10 M @ 300 (12)	10 M @ 300 (12)
	1.53 (5.0)	15 M @ 150 (6)	15 M @ 300 (12)	15 M @ 450 (18)	15 M @ 300 (12)	15 M @ 150 (6)	15 M @ 300 (12)	15 M @ 450 (18)	15 M @ 300 (12)
	1.83 (6.0)	15 M @ 150 (6)	15 M @ 150 (6)	15 M @ 300 (12)	15 M @ 300 (12)	15 M @ 150 (6)	15 M @ 150 (6)	15 M @ 300 (12)	15 M @ 300 (12)
	2.13 (7.0)		15 M @ 150 (6)	15 M @ 150 (6)	15 M @ 150 (6)	15 M @ 150 (6)	15 M @ 150 (6)	15 M @ 150 (6)	15 M @ 150 (6)
	2.44 (8.0)			15 M @ 150 (6)	15 M @ 150 (6)			15 M @ 150 (6)	15 M @ 150 (6)
3.66 (12.0)	1.22 (4.0)	15 M @ 300 (12)	10 M @ 300 (12)	10 M @ 300 (12)	10 M @ 300 (12)	15 M @ 300 (12)	15 M @ 450 (18)	10 M @ 300 (12)	10 M @ 300 (12)
	1.53 (5.0)	15 M @ 150 (6)	15 M @ 300 (12)	15 M @ 450 (18)	15 M @ 300 (12)	15 M @ 150 (6)	15 M @ 300 (12)	15 M @ 450 (18)	15 M @ 300 (12)
	1.83 (6.0)		15 M @ 150 (6)	15 M @ 300 (12)	15 M @ 300 (12)	15 M @ 150 (6)	15 M @ 150 (6)	15 M @ 150 (6)	15 M @ 300 (12)
	2.13 (7.0)		15 M @ 150 (6)	15 M @ 150 (6)	15 M @ 150 (6)	15 M @ 150 (6)	15 M @ 150 (6)	15 M @ 150 (6)	15 M @ 150 (6)
	2.44 (8.0)			15 M @ 150 (6)	15 M @ 150 (6)			15 M @ 150 (6)	15 M @ 150 (6)
Horizontal Reinforcement	Block height of 12" and 18"	15 M @ 300 (12)	15 M @ 300 (12)	15 M @ 300 (12)	15 M @ 300 (12)	15 M @ 300 (12)	15 M @ 300 (12)	15 M @ 300 (12)	15 M @ 300 (12)
	Block Height of 16"	15 M @ 300 (12)	15 M @ 300 (12)	15 M @ 300 (12)	15 M @ 300 (12)	15 M @ 300 (12)	15 M @ 300 (12)	15 M @ 300 (12)	15 M @ 300 (12)

**NOTES:**

- For highlighted data, where the below grade wall meets all the requirements of NBCC Part 9 for a solid concrete foundation wall and supports only wood frame construction above, a 20MPa unreinforced wall is adequate as per 2020 NBCC table 9.15.4.2.A. Provide the reinforcing shown for walls supporting ICF walls above or with brick veneer supported with the brick ledge form.
- Below grade walls supporting "Drained Earth" in accordance with 2020 NBCC 9.4.4.6 may be designed for an equivalent fluid pressure of 480 kg/m<sup>3</sup>.
- This table is to be used in conjunction with the "Design Limitations" and "Below Grade Reinforcement Placement" drawing.
- Provide 3 horizontal bars in every two rows of 18" high block to achieve an average spacing of 12" o.c. where 12" spacing o.c. is specified for horizontal bars, as shown in Detail A.4.
- Provide 4 horizontal bars in every three rows of 16" high block to achieve an average spacing of 12" o.c. where 12" spacing o.c. is specified for horizontal bars, as shown in Detail A.5.

**Table B.4.1. Continued– Below Grade Wall Distributed Reinforcement for Seismic Zone Classification,  $0.31 < S_{a,ICF} \leq 0.79$  and Hourly Wind Pressure,  $q_{1/50} \leq 1.05\text{kPa}$ , for ICF Walls with 6" Tie Spacing**

Wall Height m (ft)	Backfill Height m (ft)	Vertical Steel (Size and Spacing)							
		Backfill Equivalent Fluid Density							
		960 kg/m <sup>3</sup> (60 pcf)				1200 kg/m <sup>3</sup> (75 pcf)			
		150 mm (6") Wall	200 mm (8") Wall	250 mm (10") Wall	300 mm (12") Wall	150 mm (6") Wall	200 mm (8") Wall	250 mm (10") Wall	300 mm (12") Wall
2.44 (8.0)	1.22 (4.0)	15 M @ 450 (18)	15 M @ 450 (18)	10 M @ 300 (12)	10 M @ 300 (12)	15 M @ 300 (12)	15 M @ 450 (18)	10 M @ 300 (12)	10 M @ 300 (12)
	1.53 (5.0)	15 M @ 150 (6)	15 M @ 450 (18)	15 M @ 450 (18)	15 M @ 450 (18)	15 M @ 150 (6)	15 M @ 300 (12)	15 M @ 450 (18)	15 M @ 450 (18)
	1.83 (6.0)	15 M @ 150 (6)	15 M @ 300 (12)	15 M @ 300 (12)	15 M @ 300 (12)	15 M @ 150 (6)	15 M @ 150 (6)	15 M @ 300 (12)	15 M @ 300 (12)
	2.13 (7.0)		15 M @ 150 (6)	15 M @ 300 (12)	15 M @ 300 (12)		15 M @ 150 (6)	15 M @ 300 (12)	15 M @ 300 (12)
	2.44 (8.0)		15 M @ 150 (6)	15 M @ 150 (6)	15 M @ 150 (6)	15 M @ 300 (12)		15 M @ 150 (6)	15 M @ 150 (6)
2.74 (9.0)	1.22 (4.0)	15 M @ 300 (12)	15 M @ 450 (18)	10 M @ 300 (12)	10 M @ 300 (12)	15 M @ 300 (12)	15 M @ 450 (18)	10 M @ 300 (12)	10 M @ 300 (12)
	1.53 (5.0)	15 M @ 150 (6)	15 M @ 300 (12)	15 M @ 450 (18)	10 M @ 150 (6)	15 M @ 150 (6)	15 M @ 300 (12)	15 M @ 450 (18)	15 M @ 300 (12)
	1.83 (6.0)	15 M @ 150 (6)	15 M @ 150 (6)	15 M @ 300 (12)	15 M @ 300 (12)	15 M @ 150 (6)	15 M @ 150 (6)	15 M @ 300 (12)	15 M @ 300 (12)
	2.13 (7.0)		15 M @ 150 (6)	15 M @ 150 (6)	15 M @ 300 (12)		15 M @ 150 (6)	15 M @ 150 (6)	15 M @ 300 (12)
	2.44 (8.0)		15 M @ 150 (6)	15 M @ 150 (6)	15 M @ 150 (6)		15 M @ 150 (6)	15 M @ 150 (6)	15 M @ 150 (6)
2.74 (9.0)			15 M @ 150 (6)	15 M @ 150 (6)	15 M @ 150 (6)		15 M @ 150 (6)	15 M @ 150 (6)	
3.05 (10.0)	1.22 (4.0)	15 M @ 300 (12)	15 M @ 450 (18)	10 M @ 300 (12)	10 M @ 300 (12)	15 M @ 300 (12)	15 M @ 450 (18)	10 M @ 300 (12)	10 M @ 300 (12)
	1.53 (5.0)	15 M @ 150 (6)	15 M @ 300 (12)	15 M @ 450 (18)	15 M @ 300 (12)	15 M @ 150 (6)	15 M @ 300 (12)	15 M @ 450 (18)	15 M @ 300 (12)
	1.83 (6.0)	15 M @ 150 (6)	15 M @ 150 (6)	15 M @ 300 (12)	15 M @ 300 (12)		15 M @ 150 (6)	15 M @ 300 (12)	15 M @ 300 (12)
	2.13 (7.0)		15 M @ 150 (6)	15 M @ 150 (6)	15 M @ 150 (6)		15 M @ 150 (6)	15 M @ 150 (6)	15 M @ 150 (6)
	2.44 (8.0)			15 M @ 150 (6)	15 M @ 150 (6)			15 M @ 150 (6)	15 M @ 150 (6)
3.05 (10.0)			15 M @ 150 (6)	15 M @ 150 (6)	15 M @ 150 (6)		15 M @ 150 (6)	15 M @ 150 (6)	
3.35 (11.0)	1.22 (4.0)	15 M @ 300 (12)	15 M @ 450 (18)	10 M @ 300 (12)	10 M @ 300 (12)	15 M @ 300 (12)	15 M @ 450 (18)	10 M @ 300 (12)	10 M @ 300 (12)
	1.53 (5.0)	15 M @ 150 (6)	15 M @ 300 (12)	15 M @ 450 (18)	15 M @ 300 (12)	15 M @ 150 (6)	15 M @ 300 (12)	15 M @ 300 (12)	15 M @ 300 (12)
	1.83 (6.0)		15 M @ 150 (6)	15 M @ 150 (6)	15 M @ 300 (12)		15 M @ 150 (6)	15 M @ 150 (6)	15 M @ 300 (12)
	2.13 (7.0)		15 M @ 150 (6)	15 M @ 150 (6)	15 M @ 300 (12)		15 M @ 150 (6)	15 M @ 150 (6)	15 M @ 150 (6)
	2.44 (8.0)			15 M @ 150 (6)	15 M @ 150 (6)			15 M @ 150 (6)	15 M @ 150 (6)
2.74 (9.0)			15 M @ 150 (6)	15 M @ 150 (6)			15 M @ 150 (6)	15 M @ 150 (6)	
3.05 (10.0)				15 M @ 150 (6)				15 M @ 150 (6)	
3.35 (11.0)				15 M @ 150 (6)				15 M @ 150 (6)	
3.66 (12.0)	1.22 (4.0)	15 M @ 300 (12)	10 M @ 300 (12)	10 M @ 300 (12)	10 M @ 300 (12)	15 M @ 300 (12)	15 M @ 450 (18)	10 M @ 300 (12)	10 M @ 300 (12)
	1.53 (5.0)	15 M @ 150 (6)	15 M @ 300 (12)	15 M @ 450 (18)	15 M @ 300 (12)	15 M @ 150 (6)	15 M @ 300 (12)	15 M @ 300 (12)	15 M @ 300 (12)
	1.83 (6.0)		15 M @ 150 (6)	15 M @ 150 (6)	15 M @ 300 (12)		15 M @ 150 (6)	15 M @ 150 (6)	15 M @ 300 (12)
	2.13 (7.0)			15 M @ 150 (6)	15 M @ 150 (6)			15 M @ 150 (6)	15 M @ 150 (6)
	2.44 (8.0)				15 M @ 150 (6)				15 M @ 150 (6)
2.74 (9.0)				15 M @ 150 (6)				15 M @ 150 (6)	
3.05 (10.0)									
3.35 (11.0)									
3.66 (12.0)									
Horizontal Reinforcement	Block height of 12" and 18"	15 M @ 300 (12)	15 M @ 300 (12)	15 M @ 300 (12)	15 M @ 300 (12)	15 M @ 300 (12)	15 M @ 300 (12)	15 M @ 300 (12)	15 M @ 300 (12)
	Block Height of 16"	15 M @ 300 (12)	15 M @ 300 (12)	15 M @ 300 (12)	15 M @ 300 (12)	15 M @ 300 (12)	15 M @ 300 (12)	15 M @ 300 (12)	15 M @ 300 (12)

NOTES:

1. For highlighted data, where the below grade wall meets all the requirements of NBCC Part 9 for a solid concrete foundation wall and supports only wood frame construction above, a 20MPa unreinforced wall is adequate as per 2020 NBCC table 9.15.4.2.A. Provide the reinforcing shown for walls supporting ICF walls above or with brick veneer supported with the brick ledge form.
2. Below grade walls supporting "Drained Earth" in accordance with 2020 NBCC 9.4.4.6 may be designed for an equivalent fluid pressure of 480 kg/m<sup>3</sup>.
3. This table is to be used in conjunction with the "Design Limitations" and "Below Grade Reinforcement Placement" drawing.
4. Provide 3 horizontal bars in every two rows of 18" high block to achieve an average spacing of 12" o.c. where 12" spacing o.c. is specified for horizontal bars, as shown in Detail A.4.
5. Provide 4 horizontal bars in every three rows of 16" high block to achieve an average spacing of 12" o.c. where 12" spacing o.c. is specified for horizontal bars, as shown in Detail A.5.

**Table B.4.2. – Below Grade Wall Distributed Reinforcement for Seismic Zone Classification,  $0.31 < S_{a,ICF} \leq 0.79$  and Hourly Wind Pressure,  $q_{1/50} \leq 1.05kPa$ , for ICF Walls with 8" Tie Spacing**

Wall Height m (ft)	Backfill Height m (ft)	Vertical Steel (Size and Spacing)							
		Backfill Equivalent Fluid Density							
		480 kg/m <sup>3</sup> (30 pcf)				720 kg/m <sup>3</sup> (45 pcf)			
		150 mm (6") Wall	200 mm (8") Wall	250 mm (10") Wall	300 mm (12") Wall	150 mm (6") Wall	200 mm (8") Wall	250 mm (10") Wall	300 mm (12") Wall
2.44 (8.0)	1.22 (4.0)	15 M @ 400 (16)	15 M @ 400 (16)	15 M @ 600 (24)	10 M @ 400 (16)	15 M @ 400 (16)	15 M @ 400 (16)	10 M @ 200 (8)	10 M @ 400 (16)
	1.53 (5.0)	15 M @ 200 (8)	15 M @ 400 (16)	15 M @ 400 (16)	10 M @ 200 (8)	15 M @ 200 (8)	15 M @ 400 (16)	15 M @ 400 (16)	10 M @ 200 (8)
	1.83 (6.0)	15 M @ 200 (8)	15 M @ 200 (8)	15 M @ 400 (16)	15 M @ 200 (8)	15 M @ 200 (8)	15 M @ 200 (8)	15 M @ 400 (16)	15 M @ 200 (8)
	2.13 (7.0)		15 M @ 200 (8)	15 M @ 200 (8)	15 M @ 200 (8)	15 M @ 200 (8)	15 M @ 200 (8)	15 M @ 200 (8)	15 M @ 200 (8)
	2.44 (8.0)			15 M @ 200 (8)	15 M @ 200 (8)	15 M @ 200 (8)	15 M @ 200 (8)	15 M @ 200 (8)	15 M @ 200 (8)
2.74 (9.0)	1.22 (4.0)	15 M @ 400 (16)	10 M @ 200 (8)	10 M @ 200 (8)	10 M @ 400 (16)	15 M @ 400 (16)	10 M @ 200 (8)	10 M @ 200 (8)	10 M @ 400 (16)
	1.53 (5.0)	15 M @ 200 (8)	15 M @ 400 (16)	15 M @ 400 (16)	15 M @ 400 (16)	15 M @ 200 (8)	15 M @ 400 (16)	15 M @ 400 (16)	15 M @ 400 (16)
	1.83 (6.0)		15 M @ 200 (8)	15 M @ 200 (8)	15 M @ 200 (8)	15 M @ 200 (8)	15 M @ 200 (8)	15 M @ 200 (8)	15 M @ 200 (8)
	2.13 (7.0)		15 M @ 200 (8)	15 M @ 200 (8)	15 M @ 200 (8)	15 M @ 200 (8)	15 M @ 200 (8)	15 M @ 200 (8)	15 M @ 200 (8)
	2.44 (8.0)			15 M @ 200 (8)	15 M @ 200 (8)	15 M @ 200 (8)	15 M @ 200 (8)	15 M @ 200 (8)	15 M @ 200 (8)
3.05 (10.0)	1.22 (4.0)	15 M @ 400 (16)	10 M @ 200 (8)	10 M @ 200 (8)	10 M @ 400 (16)	15 M @ 400 (16)	10 M @ 200 (8)	10 M @ 200 (8)	10 M @ 400 (16)
	1.53 (5.0)	15 M @ 200 (8)	15 M @ 400 (16)	15 M @ 400 (16)	15 M @ 400 (16)	15 M @ 200 (8)	15 M @ 200 (8)	15 M @ 400 (16)	15 M @ 400 (16)
	1.83 (6.0)		15 M @ 200 (8)	15 M @ 200 (8)	15 M @ 200 (8)	15 M @ 200 (8)	15 M @ 200 (8)	15 M @ 200 (8)	15 M @ 200 (8)
	2.13 (7.0)			15 M @ 200 (8)	15 M @ 200 (8)	15 M @ 200 (8)	15 M @ 200 (8)	15 M @ 200 (8)	15 M @ 200 (8)
	2.44 (8.0)			15 M @ 200 (8)	15 M @ 200 (8)	15 M @ 200 (8)	15 M @ 200 (8)	15 M @ 200 (8)	15 M @ 200 (8)
3.35 (11.0)	1.22 (4.0)	15 M @ 400 (16)	10 M @ 200 (8)	10 M @ 200 (8)	10 M @ 400 (16)	15 M @ 400 (16)	10 M @ 200 (8)	10 M @ 200 (8)	15 M @ 400 (16)
	1.53 (5.0)	15 M @ 200 (8)	15 M @ 200 (8)	15 M @ 400 (16)	15 M @ 400 (16)	15 M @ 200 (8)	15 M @ 200 (8)	15 M @ 400 (16)	15 M @ 400 (16)
	1.83 (6.0)		15 M @ 200 (8)	15 M @ 200 (8)	15 M @ 200 (8)	15 M @ 200 (8)	15 M @ 200 (8)	15 M @ 200 (8)	15 M @ 200 (8)
	2.13 (7.0)			15 M @ 200 (8)	15 M @ 200 (8)	15 M @ 200 (8)	15 M @ 200 (8)	15 M @ 200 (8)	15 M @ 200 (8)
	2.44 (8.0)				15 M @ 200 (8)	15 M @ 200 (8)	15 M @ 200 (8)	15 M @ 200 (8)	15 M @ 200 (8)
3.66 (12.0)	1.22 (4.0)	15 M @ 400 (16)	10 M @ 200 (8)	10 M @ 200 (8)	15 M @ 600 (24)	15 M @ 400 (16)	10 M @ 200 (8)	10 M @ 200 (8)	15 M @ 400 (16)
	1.53 (5.0)	15 M @ 200 (8)	15 M @ 200 (8)	15 M @ 400 (16)	15 M @ 400 (16)	15 M @ 200 (8)	15 M @ 200 (8)	15 M @ 400 (16)	15 M @ 400 (16)
	1.83 (6.0)		15 M @ 200 (8)	15 M @ 200 (8)	15 M @ 200 (8)	15 M @ 200 (8)	15 M @ 200 (8)	15 M @ 200 (8)	15 M @ 200 (8)
	2.13 (7.0)			15 M @ 200 (8)	15 M @ 200 (8)	15 M @ 200 (8)	15 M @ 200 (8)	15 M @ 200 (8)	15 M @ 200 (8)
	2.44 (8.0)				15 M @ 200 (8)	15 M @ 200 (8)	15 M @ 200 (8)	15 M @ 200 (8)	15 M @ 200 (8)
Horizontal Reinforcement	Block height of 12" and 18"	15 M @ 300 (12)	15 M @ 300 (12)	15 M @ 300 (12)	15 M @ 300 (12)	15 M @ 300 (12)	15 M @ 300 (12)	15 M @ 300 (12)	15 M @ 300 (12)
	Block Height of 16"	15 M @ 300 (12)	15 M @ 300 (12)	15 M @ 300 (12)	15 M @ 300 (12)	15 M @ 300 (12)	15 M @ 300 (12)	15 M @ 300 (12)	15 M @ 300 (12)

**NOTES:**

- For highlighted data, where the below grade wall meets all the requirements of NBCC Part 9 for a solid concrete foundation wall and supports only wood frame construction above, a 20MPa unreinforced wall is adequate as per 2020 NBCC table 9.15.4.2.A. Provide the reinforcing shown for walls supporting ICF walls above or with brick veneer supported with the brick ledge form.
- Below grade walls supporting "Drained Earth" in accordance with 2020 NBCC 9.4.4.6 may be designed for an equivalent fluid pressure of 480 kg/m<sup>3</sup>.
- This table is to be used in conjunction with the "Design Limitations" and "Below Grade Reinforcement Placement" drawing.
- Provide 3 horizontal bars in every two rows of 18" high block to achieve an average spacing of 12" o.c. where 12" spacing o.c. is specified for horizontal bars, as shown in Detail A.4.
- Provide 4 horizontal bars in every three rows of 16" high block to achieve an average spacing of 12" o.c. where 12" spacing o.c. is specified for horizontal bars, as shown in Detail A.5.

**Table B.4.2. Continued– Below Grade Wall Distributed Reinforcement for Seismic Zone Classification,  $0.31 < S_{a,ICF} \leq 0.79$  and Hourly Wind Pressure,  $q_{1/50} \leq 1.05\text{kPa}$ , for ICF Walls with 8" Tie Spacing**

Wall Height m (ft)	Backfill Height m (ft)	Vertical Steel (Size and Spacing)							
		Backfill Equivalent Fluid Density							
		960 kg/m <sup>3</sup> (60 pcf)				1200 kg/m <sup>3</sup> (75 pcf)			
		150 mm (6") Wall	200 mm (8") Wall	250 mm (10") Wall	300 mm (12") Wall	150 mm (6") Wall	200 mm (8") Wall	250 mm (10") Wall	300 mm (12") Wall
2.44 (8.0)	1.22 (4.0)	15 M @ 400 (16)	10 M @ 200 (8)	10 M @ 200 (8)	10 M @ 400 (16)	15 M @ 400 (16)	10 M @ 200 (8)	10 M @ 200 (8)	15 M @ 400 (16)
	1.53 (5.0)	15 M @ 200 (8)	15 M @ 400 (16)	15 M @ 400 (16)	10 M @ 200 (8)	15 M @ 200 (8)	15 M @ 400 (16)	15 M @ 400 (16)	15 M @ 400 (16)
	1.83 (6.0)		15 M @ 200 (8)	15 M @ 400 (16)	15 M @ 200 (8)	15 M @ 200 (8)	15 M @ 200 (8)	15 M @ 200 (8)	15 M @ 200 (8)
	2.13 (7.0)		15 M @ 200 (8)	15 M @ 200 (8)	15 M @ 200 (8)	15 M @ 200 (8)	15 M @ 200 (8)	15 M @ 200 (8)	15 M @ 200 (8)
	2.44 (8.0)			15 M @ 200 (8)	15 M @ 200 (8)	15 M @ 200 (8)	15 M @ 200 (8)	15 M @ 200 (8)	15 M @ 200 (8)
2.74 (9.0)	1.22 (4.0)	15 M @ 400 (16)	10 M @ 200 (8)	10 M @ 200 (8)	15 M @ 400 (16)	15 M @ 400 (16)	10 M @ 200 (8)	10 M @ 200 (8)	15 M @ 400 (16)
	1.53 (5.0)	15 M @ 200 (8)	15 M @ 400 (16)	15 M @ 400 (16)	15 M @ 400 (16)	15 M @ 200 (8)	15 M @ 200 (8)	15 M @ 400 (16)	15 M @ 400 (16)
	1.83 (6.0)		15 M @ 200 (8)	15 M @ 200 (8)	15 M @ 200 (8)	15 M @ 200 (8)	15 M @ 200 (8)	15 M @ 200 (8)	15 M @ 200 (8)
	2.13 (7.0)			15 M @ 200 (8)	15 M @ 200 (8)	15 M @ 200 (8)	15 M @ 200 (8)	15 M @ 200 (8)	15 M @ 200 (8)
	2.44 (8.0)			15 M @ 200 (8)	15 M @ 200 (8)	15 M @ 200 (8)	15 M @ 200 (8)	15 M @ 200 (8)	15 M @ 200 (8)
3.05 (10.0)	1.22 (4.0)	15 M @ 400 (16)	10 M @ 200 (8)	10 M @ 200 (8)	15 M @ 400 (16)	15 M @ 400 (16)	10 M @ 200 (8)	10 M @ 200 (8)	15 M @ 400 (16)
	1.53 (5.0)	15 M @ 200 (8)	15 M @ 200 (8)	15 M @ 400 (16)	15 M @ 400 (16)	15 M @ 200 (8)	15 M @ 200 (8)	15 M @ 400 (16)	15 M @ 400 (16)
	1.83 (6.0)		15 M @ 200 (8)	15 M @ 200 (8)	15 M @ 200 (8)	15 M @ 200 (8)	15 M @ 200 (8)	15 M @ 200 (8)	15 M @ 200 (8)
	2.13 (7.0)			15 M @ 200 (8)	15 M @ 200 (8)	15 M @ 200 (8)	15 M @ 200 (8)	15 M @ 200 (8)	15 M @ 200 (8)
	2.44 (8.0)			15 M @ 200 (8)	15 M @ 200 (8)	15 M @ 200 (8)	15 M @ 200 (8)	15 M @ 200 (8)	15 M @ 200 (8)
3.35 (11.0)	1.22 (4.0)	15 M @ 400 (16)	10 M @ 200 (8)	10 M @ 200 (8)	15 M @ 400 (16)	15 M @ 200 (8)	10 M @ 200 (8)	15 M @ 600 (24)	15 M @ 400 (16)
	1.53 (5.0)	15 M @ 200 (8)	15 M @ 200 (8)	15 M @ 400 (16)	15 M @ 400 (16)	15 M @ 200 (8)	15 M @ 200 (8)	15 M @ 400 (16)	15 M @ 200 (8)
	1.83 (6.0)		15 M @ 200 (8)	15 M @ 200 (8)	15 M @ 200 (8)	15 M @ 200 (8)	15 M @ 200 (8)	15 M @ 200 (8)	15 M @ 200 (8)
	2.13 (7.0)			15 M @ 200 (8)	15 M @ 200 (8)	15 M @ 200 (8)	15 M @ 200 (8)	15 M @ 200 (8)	15 M @ 200 (8)
	2.44 (8.0)			15 M @ 200 (8)	15 M @ 200 (8)	15 M @ 200 (8)	15 M @ 200 (8)	15 M @ 200 (8)	15 M @ 200 (8)
3.66 (12.0)	1.22 (4.0)	15 M @ 400 (16)	10 M @ 200 (8)	10 M @ 200 (8)	15 M @ 400 (16)	15 M @ 200 (8)	10 M @ 200 (8)	15 M @ 600 (24)	15 M @ 400 (16)
	1.53 (5.0)	15 M @ 200 (8)	15 M @ 200 (8)	15 M @ 400 (16)	15 M @ 200 (8)	15 M @ 200 (8)	15 M @ 200 (8)	15 M @ 400 (16)	15 M @ 200 (8)
	1.83 (6.0)		15 M @ 200 (8)	15 M @ 200 (8)	15 M @ 200 (8)	15 M @ 200 (8)	15 M @ 200 (8)	15 M @ 200 (8)	15 M @ 200 (8)
	2.13 (7.0)			15 M @ 200 (8)	15 M @ 200 (8)	15 M @ 200 (8)	15 M @ 200 (8)	15 M @ 200 (8)	15 M @ 200 (8)
	2.44 (8.0)			15 M @ 200 (8)	15 M @ 200 (8)	15 M @ 200 (8)	15 M @ 200 (8)	15 M @ 200 (8)	15 M @ 200 (8)
Horizontal Reinforcement	Block height of 12" and 18"	15 M @ 300 (12)	15 M @ 300 (12)	15 M @ 300 (12)	15 M @ 300 (12)	15 M @ 300 (12)	15 M @ 300 (12)	15 M @ 300 (12)	15 M @ 300 (12)
	Block Height of 16"	15 M @ 300 (12)	15 M @ 300 (12)	15 M @ 300 (12)	15 M @ 300 (12)	15 M @ 300 (12)	15 M @ 300 (12)	15 M @ 300 (12)	15 M @ 300 (12)

NOTES:

- For highlighted data, where the below grade wall meets all the requirements of NBCC Part 9 for a solid concrete foundation wall and supports only wood frame construction above, a 20MPa unreinforced wall is adequate as per 2020 NBCC table 9.15.4.2.A. Provide the reinforcing shown for walls supporting ICF walls above or with brick veneer supported with the brick ledge form.
- Below grade walls supporting "Drained Earth" in accordance with 2020 NBCC 9.4.4.6 may be designed for an equivalent fluid pressure of 480 kg/m<sup>3</sup>.
- This table is to be used in conjunction with the "Design Limitations" and "Below Grade Reinforcement Placement" drawing.
- Provide 3 horizontal bars in every two rows of 18" high block to achieve an average spacing of 12" o.c. where 12" spacing o.c. is specified for horizontal bars, as shown in Detail A.4.
- Provide 4 horizontal bars in every three rows of 16" high block to achieve an average spacing of 12" o.c. where 12" spacing o.c. is specified for horizontal bars, as shown in Detail A.5.



**Table A.1.1. Above Grade Wall Distributed Reinforcement for Seismic Zone Classification,  $S_{a,ICF} \leq 0.16$  and Hourly Wind Pressure,  $q_{1/50} \leq 1.05\text{kPa}$ , for ICF Walls with 6" Tie Spacing**

Wall Height m (ft)		Distributed Vertical Reinforcement (Size and Spacing)			
		150 mm (6") Wall	200 mm (8") Wall	250 mm (10") Wall	300 mm (12") Wall
<b>Hourly Wind Pressure <math>q_{1/50} \leq 0.5\text{ kPa}</math></b>					
2.44 (8)		10 M @ 600 (24)	10 M @ 750 (30)	10 M @ 900 (36)	10 M @ 1200 (48)
2.75 (9)		10 M @ 600 (24)	10 M @ 750 (30)	10 M @ 900 (36)	10 M @ 1200 (48)
3.05 (10)		15 M @ 900 (36)	10 M @ 750 (30)	10 M @ 900 (36)	10 M @ 1200 (48)
3.66 (12)		<b>15 M @ 750 (30)</b>	<b>15 M @ 900 (36)</b>	<b>10 M @ 600 (24)</b>	<b>10 M @ 1200 (48)</b>
4.27 (14)		<b>15 M @ 300 (12)</b>	<b>15 M @ 750 (30)</b>	<b>15 M @ 900 (36)</b>	<b>10 M @ 1200 (48)</b>
4.88 (16)		<b>15 M @ 300 (12)</b>	<b>15 M @ 600 (24)</b>	<b>15 M @ 750 (30)</b>	<b>10 M @ 900 (36)</b>
<b>Hourly Wind Pressure <math>q_{1/50} \leq 0.75\text{ kPa}</math></b>					
2.44 (8)		15 M @ 1050 (42)	10 M @ 750 (30)	10 M @ 900 (36)	10 M @ 1200 (48)
2.75 (9)		15 M @ 750 (30)	10 M @ 600 (24)	10 M @ 750 (30)	10 M @ 1200 (48)
3.05 (10)		15 M @ 600 (24)	15 M @ 1050 (42)	10 M @ 600 (24)	10 M @ 1200 (48)
3.66 (12)		<b>15 M @ 300 (12)</b>	<b>15 M @ 750 (30)</b>	<b>15 M @ 900 (36)</b>	<b>10 M @ 1200 (48)</b>
4.27 (14)		<b>15 M @ 300 (12)</b>	<b>15 M @ 450 (18)</b>	<b>15 M @ 750 (30)</b>	<b>10 M @ 750 (30)</b>
4.88 (16)		<b>15 M @ 150 (6)</b>	<b>15 M @ 300 (12)</b>	<b>15 M @ 300 (12)</b>	<b>15 M @ 750 (30)</b>
<b>Hourly Wind Pressure <math>q_{1/50} \leq 1.05\text{ kPa}</math></b>					
2.44 (8)		15 M @ 750 (30)	15 M @ 900 (36)	10 M @ 600 (24)	10 M @ 1200 (48)
2.75 (9)		15 M @ 600 (24)	15 M @ 750 (30)	15 M @ 1200 (48)	10 M @ 1200 (48)
3.05 (10)		15 M @ 450 (18)	15 M @ 750 (30)	15 M @ 750 (30)	10 M @ 900 (36)
3.66 (12)		<b>15 M @ 300 (12)</b>	<b>15 M @ 300 (12)</b>	<b>15 M @ 600 (24)</b>	<b>10 M @ 750 (30)</b>
4.27 (14)		<b>15 M @ 150 (6)</b>	<b>15 M @ 300 (12)</b>	<b>15 M @ 300 (12)</b>	<b>15 M @ 900 (36)</b>
4.88 (16)			<b>15 M @ 150 (6)</b>	<b>15 M @ 300 (12)</b>	<b>15 M @ 750 (30)</b>
Horizontal	Block Height of 12" and 18"	10 M @ 900 (36)	10 M @ 900 (36)	10 M @ 900 (36)	10 M @ 900 (36)
	Block Height of 16"	10 M @ 800 (32)	10 M @ 800 (32)	10 M @ 800 (32)	10 M @ 800 (32)

NOTES:

1.  $S_{a,ICF}$  is equivalent spectral response acceleration for ICF walls as provided in Appendix A.
2. Provide two layers of the indicated horizontal and vertical distributed steel specified for 300mm (12") walls. Place each layer as shown in the rebar placement drawing.
3. This table is to be used in conjunction with the "Design Limitations."
4. Bolded data indicates reinforcing for ground floor concrete walls only. Second floor concrete walls to be limited in height to 3.0m (10'-0").

**INSULATING CONCRETE FORMS  
MANUFACTURERS ASSOCIATION**

**Table A.1.2. Above Grade Wall Distributed Reinforcement for Seismic Zone Classification,  $S_{a,ICF} \leq 0.16$  and Hourly Wind Pressure,  $q_{1/50} \leq 1.05\text{kPa}$ , for ICF Walls with 8" Tie Spacing**

Wall Height m (ft)	Distributed Vertical and Reinforcement (Size and Spacing)				
	150 mm (6") Wall	200 mm (8") Wall	250 mm (10") Wall	300 mm (12") Wall	
<b>Hourly Wind Pressure <math>q_{1/50} \leq 0.5\text{ kPa}</math></b>					
2.44 (8)	10 M @ 600 (24)	10 M @ 800 (32)	10 M @ 1000 (40)	10 M @ 1200 (48)	
2.75 (9)	10 M @ 600 (24)	10 M @ 800 (32)	10 M @ 1000 (40)	10 M @ 1200 (48)	
3.05 (10)	15 M @ 1000 (40)	10 M @ 800 (32)	10 M @ 1000 (40)	10 M @ 1200 (48)	
3.66 (12)	<b>15 M @ 800 (32)</b>	<b>15 M @ 1000 (40)</b>	<b>10 M @ 600 (24)</b>	<b>10 M @ 1200 (48)</b>	
4.27 (14)	<b>15 M @ 400 (16)</b>	<b>15 M @ 800 (32)</b>	<b>15 M @ 1000 (40)</b>	<b>10 M @ 1200 (48)</b>	
4.88 (16)	<b>15 M @ 400 (16)</b>	<b>15 M @ 600 (24)</b>	<b>15 M @ 800 (32)</b>	<b>10 M @ 1000 (40)</b>	
<b>Hourly Wind Pressure <math>q_{1/50} \leq 0.75\text{ kPa}</math></b>					
2.44 (8)	15 M @ 1200 (48)	10 M @ 800 (32)	10 M @ 1000 (40)	10 M @ 1200 (48)	
2.75 (9)	15 M @ 800 (32)	10 M @ 600 (24)	10 M @ 800 (32)	10 M @ 1200 (48)	
3.05 (10)	15 M @ 600 (24)	15 M @ 1200 (48)	10 M @ 600 (24)	10 M @ 1200 (48)	
3.66 (12)	<b>15 M @ 400 (16)</b>	<b>15 M @ 800 (32)</b>	<b>15 M @ 1000 (40)</b>	<b>10 M @ 1200 (48)</b>	
4.27 (14)	<b>15 M @ 400 (16)</b>	<b>15 M @ 600 (24)</b>	<b>15 M @ 800 (32)</b>	<b>10 M @ 800 (32)</b>	
4.88 (16)	<b>15 M @ 200 (8)</b>	<b>15 M @ 400 (16)</b>	<b>15 M @ 400 (16)</b>	<b>15 M @ 800 (32)</b>	
<b>Hourly Wind Pressure <math>q_{1/50} \leq 1.05\text{ kPa}</math></b>					
2.44 (8)	15 M @ 800 (32)	15 M @ 1000 (40)	10 M @ 600 (24)	10 M @ 1200 (48)	
2.75 (9)	15 M @ 600 (24)	15 M @ 800 (32)	15 M @ 1200 (48)	10 M @ 1200 (48)	
3.05 (10)	15 M @ 600 (24)	15 M @ 800 (32)	15 M @ 800 (32)	10 M @ 1000 (40)	
3.66 (12)	<b>15 M @ 400 (16)</b>	<b>15 M @ 400 (16)</b>	<b>15 M @ 600 (24)</b>	<b>10 M @ 800 (32)</b>	
4.27 (14)	<b>15 M @ 200 (8)</b>	<b>15 M @ 400 (16)</b>	<b>15 M @ 400 (16)</b>	<b>15 M @ 1000 (40)</b>	
4.88 (16)		<b>15 M @ 200 (8)</b>	<b>15 M @ 400 (16)</b>	<b>15 M @ 800 (32)</b>	
Horizontal Reinforcement	Block Height of 12" and 18"	10 M @ 900 (36)	10 M @ 900 (36)	10 M @ 900 (36)	10 M @ 900 (36)
	Block Height of 16"	10 M @ 800 (32)	10 M @ 800 (32)	10 M @ 800 (32)	10 M @ 800 (32)

**NOTES:**

1.  $S_{a,ICF}$  is equivalent spectral response acceleration for ICF walls as provided in Appendix A.
2. Provide two layers of the indicated horizontal and vertical distributed steel specified for 300mm (12") walls. Place each layer as shown in the rebar placement drawing.
3. This table is to be used in conjunction with the "Design Limitations."
4. Bolded data indicates reinforcing for ground floor concrete walls only. Second floor concrete walls to be limited in height to 3.0m (10'-0").
5. Alternating vertical bar spacing of 8" o.c. and 16" o.c. may be used to achieve an average spacing of 12" o.c. where 12" o.c. spacing is specified for vertical bars, as shown in Detail A.5.

**INSULATING CONCRETE FORMS  
MANUFACTURERS ASSOCIATION**

**Table A.2.1. Above Grade Wall Distributed Reinforcement for Seismic Zone Classification,  $S_{a,ICF} > 0.16$  and Hourly Wind Pressure,  $q_{1/50} \leq 1.05\text{kPa}$  for, ICF Walls with 6" Tie Spacing**

Wall Height m (ft)		Distributed Vertical Reinforcement (Size and Spacing)			
		150 mm (6") Wall	200 mm (8") Wall	250 mm (10") Wall	300 mm (12") Wall
<b>Seismic zone classification, <math>S_{a,ICF} \leq 0.31</math></b>					
2.44 (8)		10 M @ 300 (12)	10 M @ 300 (12)	10 M @ 300 (12)	10 M @ 300 (12)
2.75 (9)		10 M @ 300 (12)	10 M @ 300 (12)	10 M @ 300 (12)	10 M @ 300 (12)
3.05 (10)		15 M @ 300 (12)	10 M @ 300 (12)	10 M @ 300 (12)	10 M @ 300 (12)
3.66 (12)		<b>15 M @ 300 (12)</b>	<b>15 M @ 300 (12)</b>	<b>15 M @ 600 (24)</b>	<b>10 M @ 300 (12)</b>
4.27 (14)		<b>15 M @ 300 (12)</b>	<b>15 M @ 300 (12)</b>	<b>15 M @ 300 (12)</b>	<b>10 M @ 300 (12)</b>
4.88 (16)			<b>15 M @ 300 (12)</b>	<b>15 M @ 300 (12)</b>	<b>10 M @ 300 (12)</b>
Horizontal Reinforcement	Block Height of 12" and 18"	10 M @ 450 (18)	10 M @ 450 (18)	10 M @ 450 (18)	10 M @ 450 (18)
	Block Height of 16"	10 M @ 400 (16)	10 M @ 400 (16)	10 M @ 400 (16)	10 M @ 400 (16)
<b>Seismic zone classification, <math>S_{a,ICF} \leq 0.53</math></b>					
2.44 (8)		15 M @ 300 (12)	15 M @ 300 (12)	15 M @ 300 (12)	10 M @ 300 (12)
2.75 (9)		15 M @ 300 (12)	15 M @ 300 (12)	15 M @ 300 (12)	10 M @ 300 (12)
3.05 (10)		15 M @ 300 (12)	15 M @ 300 (12)	15 M @ 300 (12)	10 M @ 300 (12)
3.66 (12)		<b>15 M @ 300 (12)</b>	<b>15 M @ 300 (12)</b>	<b>15 M @ 300 (12)</b>	<b>10 M @ 300 (12)</b>
4.27 (14)		<b>15 M @ 300 (12)</b>	<b>15 M @ 300 (12)</b>	<b>15 M @ 300 (12)</b>	<b>10 M @ 300 (12)</b>
4.88 (16)			<b>15 M @ 300 (12)</b>	<b>15 M @ 300 (12)</b>	<b>10 M @ 300 (12)</b>
Horizontal Reinforcement	Block Height of 12" and 18"	15 M @ 300 (12)	15 M @ 300 (12)	15 M @ 300 (12)	15 M @ 300 (12)
	Block Height of 16"	15 M @ 300 (12)	15 M @ 300 (12)	15 M @ 300 (12)	15 M @ 300 (12)
<b>Seismic zone classification, <math>S_{a,ICF} \leq 0.79</math></b>					
2.44 (8)		15 M @ 300 (12)	15 M @ 300 (12)	15 M @ 300 (12)	10 M @ 300 (12)
2.75 (9)		15 M @ 300 (12)	15 M @ 300 (12)	15 M @ 300 (12)	10 M @ 300 (12)
3.05 (10)		15 M @ 300 (12)	15 M @ 300 (12)	15 M @ 300 (12)	10 M @ 300 (12)
3.66 (12)		<b>15 M @ 300 (12)</b>	<b>15 M @ 300 (12)</b>	<b>15 M @ 300 (12)</b>	<b>10 M @ 300 (12)</b>
4.27 (14)		<b>15 M @ 300 (12)</b>	<b>15 M @ 300 (12)</b>	<b>15 M @ 300 (12)</b>	<b>10 M @ 300 (12)</b>
4.88 (16)			<b>15 M @ 300 (12)</b>	<b>15 M @ 300 (12)</b>	<b>10 M @ 300 (12)</b>
Horizontal Reinforcement	Block Height of 12" and 18"	15 M @ 300 (12)	15 M @ 300 (12)	15 M @ 300 (12)	15 M @ 300 (12)
	Block Height of 16"	15 M @ 300 (12)	15 M @ 300 (12)	15 M @ 300 (12)	15 M @ 300 (12)

NOTES:

1.  $S_{a,ICF}$  is equivalent spectral response acceleration for ICF walls as provided in Appendix A.
2. Provide two layers of the indicated horizontal and vertical distributed steel specified for 300mm (12") walls. Place each layer as shown in the rebar placement drawing.
3. This table is to be used in conjunction with the "Design Limitations."
4. Bolded data indicates reinforcing for ground floor concrete walls only. Second floor concrete walls to be limited in height to 3.0m (10'-0").
5. Alternating horizontal bar spacing of 12" o.c. and 24" o.c. may be used to achieve an average spacing of 18" o.c. where 18" o.c. spacing is specified for horizontal bars, as shown in Detail A.3.
6. Provide 3 horizontal bars in every two rows of 18" high block to achieve an average spacing of 12" o.c. where 12" spacing o.c. is specified for horizontal bars, as shown in Detail A.4.
7. Provide 4 horizontal bars in every three rows of 16" high block to achieve an average spacing of 12" o.c. where 12" spacing o.c. is specified for horizontal bars, as shown in Detail A.5.

INSULATING CONCRETE FORMS  
MANUFACTURERS ASSOCIATION

**Table A.2.2. Above Grade Wall Distributed Reinforcement for Seismic Zone Classification,  $S_{a,ICF} > 0.16$  and Hourly Wind Pressure,  $q_{1/50} \leq 1.05\text{kPa}$  for, ICF Walls with 8" Tie Spacing**

Wall Height m (ft)		Distributed Vertical Reinforcement (Size and Spacing)			
		150 mm (6") Wall	200 mm (8") Wall	250 mm (10") Wall	300 mm (12") Wall
<b>Seismic zone classification, <math>S_{a,ICF} \leq 0.31</math></b>					
2.44 (8)		10 M @ 300 (12)	10 M @ 300 (12)	10 M @ 300 (12)	10 M @ 400 (16)
2.75 (9)		10 M @ 300 (12)	10 M @ 300 (12)	10 M @ 300 (12)	10 M @ 400 (16)
3.05 (10)		15 M @ 400 (16)	10 M @ 300 (12)	10 M @ 300 (12)	10 M @ 400 (16)
3.66 (12)		<b>15 M @ 300 (12)</b>	<b>15 M @ 400 (16)</b>	<b>15 M @ 600 (24)</b>	<b>10 M @ 400 (16)</b>
4.27 (14)		<b>15 M @ 300 (12)</b>	<b>15 M @ 400 (16)</b>	<b>15 M @ 400 (16)</b>	<b>10 M @ 400 (16)</b>
4.88 (16)			<b>15 M @ 300 (12)</b>	<b>15 M @ 300 (12)</b>	<b>10 M @ 400 (16)</b>
Horizontal Reinforcement	Block Height of 12" and 18"	10 M @ 450 (18)	10 M @ 450 (18)	10 M @ 450 (18)	10 M @ 450 (18)
	Block Height of 16"	10 M @ 400 (16)	10 M @ 400 (16)	10 M @ 400 (16)	10 M @ 400 (16)
<b>Seismic zone classification, <math>S_{a,ICF} \leq 0.53</math></b>					
2.44 (8)		15 M @ 300 (12)	15 M @ 400 (16)	15 M @ 400 (16)	10 M @ 300 (12)
2.75 (9)		15 M @ 300 (12)	15 M @ 400 (16)	15 M @ 400 (16)	10 M @ 300 (12)
3.05 (10)		15 M @ 300 (12)	15 M @ 400 (16)	15 M @ 400 (16)	10 M @ 300 (12)
3.66 (12)		<b>15 M @ 300 (12)</b>	<b>15 M @ 400 (16)</b>	<b>15 M @ 400 (16)</b>	<b>10 M @ 300 (12)</b>
4.27 (14)		<b>15 M @ 300 (12)</b>	<b>15 M @ 400 (16)</b>	<b>15 M @ 400 (16)</b>	<b>10 M @ 300 (12)</b>
4.88 (16)			<b>15 M @ 300 (12)</b>	<b>15 M @ 400 (16)</b>	<b>10 M @ 300 (12)</b>
Horizontal Reinforcement	Block Height of 12" and 18"	15 M @ 300 (12)	15 M @ 300 (12)	15 M @ 300 (12)	15 M @ 300 (12)
	Block Height of 16"	15 M @ 300 (12)	15 M @ 300 (12)	15 M @ 300 (12)	15 M @ 300 (12)
<b>Seismic zone classification, <math>S_{a,ICF} \leq 0.79</math></b>					
2.44 (8)		15 M @ 300 (12)	15 M @ 300 (12)	15 M @ 300 (12)	10 M @ 300 (12)
2.75 (9)		15 M @ 300 (12)	15 M @ 300 (12)	15 M @ 300 (12)	10 M @ 300 (12)
3.05 (10)		15 M @ 300 (12)	15 M @ 300 (12)	15 M @ 300 (12)	10 M @ 300 (12)
3.66 (12)		<b>15 M @ 300 (12)</b>	<b>15 M @ 300 (12)</b>	<b>15 M @ 300 (12)</b>	<b>10 M @ 300 (12)</b>
4.27 (14)		<b>15 M @ 300 (12)</b>	<b>15 M @ 300 (12)</b>	<b>15 M @ 300 (12)</b>	<b>10 M @ 300 (12)</b>
4.88 (16)			<b>15 M @ 300 (12)</b>	<b>15 M @ 300 (12)</b>	<b>10 M @ 300 (12)</b>
Horizontal Reinforcement	Block Height of 12" and 18"	15 M @ 300 (12)	15 M @ 300 (12)	15 M @ 300 (12)	15 M @ 300 (12)
	Block Height of 16"	15 M @ 300 (12)	15 M @ 300 (12)	15 M @ 300 (12)	15 M @ 300 (12)

**NOTES:**

1.  $S_{a,ICF}$  is equivalent spectral response acceleration for ICF walls as provided in Appendix A.
2. Provide two layers of the indicated horizontal and vertical distributed steel specified for 300mm (12") walls. Place each layer as shown in the rebar placement drawing.
3. This table is to be used in conjunction with the "Design Limitations."
4. Bolded data indicates reinforcing for ground floor concrete walls only. Second floor concrete walls to be limited in height to 3.0m (10'-0").
5. Alternating horizontal bar spacing of 12" o.c. and 24" o.c. may be used to achieve an average spacing of 18" o.c. where 18" o.c. spacing is specified for horizontal bars, as shown in Detail A.3.
6. Provide 3 horizontal bars in every two rows of 18" high block to achieve an average spacing of 12" o.c. where 12" spacing o.c. is specified for horizontal bars, as shown in Detail A.4.
7. Provide 4 horizontal bars in every three rows of 16" high block to achieve an average spacing of 12" o.c. where 12" spacing o.c. is specified for horizontal bars, as shown in Detail A.5.
8. Alternating vertical bar spacing of 8" o.c. and 16" o.c. may be used to achieve an average spacing of 12" o.c. where 12" o.c. spacing is specified for vertical bars, as shown in Detail A.6.

**Table A.3.3200. Above Grade Shear Wall Length for Seismic Zone Classification,  $S_{a,ICF} \leq 0.16$  and Hourly Wind Pressure,  $q_{1/50} \leq 0.5kPa$  (in a Building Without Walkout Basement), where Building Area  $\leq 3200ft^2$**

Wall Height m (ft)	Seismic Zone Classification														
	$S_{a,ICF} \leq 0.07$		$S_{a,ICF} \leq 0.11$		$S_{a,ICF} \leq 0.16$										
<b>Second Floor Walls of Two Story ICF Structure Supporting Wood Frame Roof (TYPE A)</b>															
	6" & 8" Thick Wall		10" & 12" Thick Wall		6" & 8" Thick Wall		10" & 12" Thick Wall								
	Number and length of shear walls provided														
2.44 (8)	1 x 8'-0"	2 x 4'-0"	3 x 2'-8"	1 x 8'-0"	2 x 4'-0"	3 x 2'-8"	1 x 8'-0"	2 x 4'-0"	3 x 3'-0"	1 x 8'-0"	2 x 4'-0"	3 x 3'-0"	1 x 8'-0"	2 x 4'-0"	3 x 3'-0"
2.75 (9)	1 x 8'-0"	2 x 4'-0"	3 x 2'-8"	1 x 8'-0"	2 x 4'-0"	3 x 2'-8"	1 x 8'-0"	2 x 4'-0"	3 x 3'-0"	1 x 8'-0"	2 x 4'-0"	3 x 3'-0"	1 x 8'-0"	2 x 4'-6"	3 x 3'-6"
3.05 (10)	1 x 8'-0"	2 x 4'-0"	3 x 2'-8"	1 x 8'-0"	2 x 4'-0"	3 x 2'-8"	1 x 8'-0"	2 x 4'-0"	3 x 3'-0"	1 x 8'-0"	2 x 4'-0"	3 x 3'-0"	1 x 8'-0"	2 x 4'-6"	3 x 3'-6"
<b>Main Floor Walls of One Story ICF Structure Supporting Wood Frame Roof (TYPE B)</b>															
	6" & 8" Thick Wall		10" & 12" Thick Wall		6" & 8" Thick Wall		10" & 12" Thick Wall								
	Number and length of shear walls provided														
2.44 (8)	1 x 8'-0"	2 x 4'-0"	3 x 2'-8"	1 x 8'-0"	2 x 4'-0"	3 x 2'-8"	1 x 8'-0"	2 x 4'-0"	3 x 3'-0"	1 x 8'-0"	2 x 4'-0"	3 x 3'-0"	1 x 8'-0"	2 x 4'-0"	3 x 3'-0"
2.75 (9)	1 x 8'-0"	2 x 4'-0"	3 x 2'-8"	1 x 8'-0"	2 x 4'-0"	3 x 2'-8"	1 x 8'-0"	2 x 4'-0"	3 x 3'-0"	1 x 8'-0"	2 x 4'-0"	3 x 3'-0"	1 x 8'-0"	2 x 4'-6"	3 x 3'-6"
3.05 (10)	1 x 8'-0"	2 x 4'-0"	3 x 2'-8"	1 x 8'-0"	2 x 4'-0"	3 x 2'-8"	1 x 8'-0"	2 x 4'-0"	3 x 3'-0"	1 x 8'-0"	2 x 4'-0"	3 x 3'-0"	1 x 8'-0"	2 x 4'-6"	3 x 3'-6"
3.66 (12)	1 x 8'-0"	2 x 4'-0"	3 x 3'-0"	1 x 8'-0"	2 x 4'-0"	3 x 3'-0"	1 x 8'-0"	2 x 4'-6"	3 x 3'-6"	1 x 8'-0"	2 x 4'-6"	3 x 3'-6"	1 x 9'-0"	2 x 6'-0"	3 x 4'-6"
4.27 (14)	1 x 8'-0"	2 x 4'-0"	3 x 3'-0"	1 x 8'-0"	2 x 4'-0"	3 x 3'-0"	1 x 8'-0"	2 x 5'-0"	3 x 4'-0"	1 x 8'-0"	2 x 5'-0"	3 x 4'-0"	1 x 9'-4"	2 x 6'-0"	3 x 5'-0"
4.88 (16)	1 x 8'-0"	2 x 4'-0"	3 x 3'-0"	1 x 8'-0"	2 x 5'-0"	3 x 4'-0"	1 x 8'-0"	2 x 5'-0"	3 x 4'-0"	1 x 9'-0"	2 x 6'-0"	3 x 4'-6"	1 x 10'-0"	2 x 6'-6"	3 x 5'-0"
<b>Main Floor Walls of Two Story Structure Supporting 2nd Story Wood Framed Walls, Floor and Roof (TYPE C)</b>															
	6" & 8" Thick Wall		10" & 12" Thick Wall		6" & 8" Thick Wall		10" & 12" Thick Wall								
	Number and length of shear walls provided														
2.44 (8)	1 x 8'-0"	2 x 4'-0"	3 x 3'-0"	1 x 8'-0"	2 x 4'-0"	3 x 3'-0"	1 x 9'-0"	2 x 6'-0"	3 x 5'-0"	1 x 9'-0"	2 x 6'-6"	3 x 5'-0"	1 x 11'-0"	2 x 7'-0"	3 x 5'-6"
2.75 (9)	1 x 8'-0"	2 x 4'-6"	3 x 3'-6"	1 x 8'-0"	2 x 4'-6"	3 x 3'-6"	1 x 9'-0"	2 x 6'-6"	3 x 5'-0"	1 x 10'-0"	2 x 7'-0"	3 x 5'-0"	1 x 12'-0"	2 x 7'-6"	3 x 6'-0"
3.05 (10)	1 x 8'-0"	2 x 5'-0"	3 x 4'-0"	1 x 8'-0"	2 x 5'-0"	3 x 4'-0"	1 x 9'-6"	2 x 7'-4"	3 x 6'-0"	1 x 10'-0"	2 x 7'-4"	3 x 6'-0"	1 x 12'-0"	2 x 8'-0"	3 x 6'-6"
3.66 (12)	1 x 8'-6"	2 x 5'-6"	3 x 4'-0"	1 x 8'-6"	2 x 5'-6"	3 x 4'-0"	1 x 10'-6"	2 x 8'-4"	3 x 6'-6"	1 x 10'-6"	2 x 8'-4"	3 x 6'-6"	1 x 13'-0"	2 x 9'-0"	3 x 7'-0"
4.27 (14)	1 x 8'-6"	2 x 5'-6"	3 x 4'-6"	1 x 8'-6"	2 x 6'-0"	3 x 4'-6"	1 x 11'-0"	2 x 8'-6"	3 x 7'-0"	1 x 11'-6"	2 x 9'-0"	3 x 7'-0"	1 x 13'-0"	2 x 9'-0"	3 x 7'-6"
4.88 (16)	1 x 8'-6"	2 x 5'-6"	3 x 4'-6"	1 x 9'-0"	2 x 6'-0"	3 x 5'-0"	1 x 11'-0"	2 x 9'-0"	3 x 7'-6"	1 x 12'-0"	2 x 9'-6"	3 x 7'-6"	1 x 13'-0"	2 x 9'-0"	3 x 7'-6"
<b>Main Floor Walls of Two Story ICF Structure Supporting Wood Frame Floors and Roof (TYPE D)</b>															
	6" & 8" Thick Wall		10" & 12" Thick Wall		6" & 8" Thick Wall		10" & 12" Thick Wall								
	Number and length of shear walls provided														
2.44 (8)	1 x 9'-0"	2 x 5'-6"	3 x 4'-0"	1 x 9'-0"	2 x 5'-6"	3 x 4'-6"	1 x 11'-0"	2 x 7'-0"	3 x 5'-6"	1 x 12'-0"	2 x 8'-0"	3 x 6'-0"	1 x 14'-0"	2 x 9'-0"	3 x 7'-0"
2.75 (9)	1 x 9'-0"	2 x 6'-0"	3 x 4'-0"	1 x 10'-0"	2 x 6'-0"	3 x 5'-0"	1 x 12'-0"	2 x 7'-6"	3 x 6'-0"	1 x 13'-0"	2 x 8'-0"	3 x 6'-0"	1 x 15'-0"	2 x 9'-6"	3 x 8'-0"
3.05 (10)	1 x 9'-6"	2 x 6'-0"	3 x 4'-6"	1 x 10'-0"	2 x 6'-6"	3 x 5'-0"	1 x 13'-0"	2 x 8'-0"	3 x 6'-0"	1 x 13'-0"	2 x 8'-6"	3 x 7'-0"	1 x 15'-6"	2 x 10'-0"	3 x 8'-0"
3.66 (12)	1 x 10'-0"	2 x 7'-0"	3 x 5'-0"	1 x 10'-0"	2 x 7'-0"	3 x 5'-0"	1 x 13'-6"	2 x 9'-0"	3 x 7'-0"	1 x 13'-6"	2 x 9'-0"	3 x 7'-0"	1 x 16'-0"	2 x 11'-0"	3 x 9'-0"
4.27 (14)	1 x 10'-0"	2 x 7'-0"	3 x 5'-6"	1 x 11'-0"	2 x 7'-6"	3 x 6'-0"	1 x 13'-0"	2 x 9'-0"	3 x 7'-0"	1 x 14'-6"	2 x 9'-6"	3 x 8'-0"	1 x 16'-0"	2 x 11'-0"	3 x 9'-0"
4.88 (16)	1 x 10'-0"	2 x 7'-0"	3 x 5'-6"	1 x 11'-6"	2 x 7'-6"	3 x 6'-0"	1 x 13'-0"	2 x 9'-0"	3 x 7'-0"	1 x 14'-6"	2 x 10'-0"	3 x 8'-0"	1 x 16'-0"	2 x 11'-0"	3 x 9'-0"
Vertical Reinforcement	ICF with 6" Tie Spacing	As per table A.1.1.				As per table A.1.1.				As per table A.1.1.					
Vertical Reinforcement	ICF with 8" Tie Spacing	As per table A.1.2.				As per table A.1.2.				As per table A.1.2.					
Horizontal Reinforcement	Block Height of 12" and 18"	10 M @	450 (18)					10 M @	450 (18)						
Horizontal Reinforcement	Block Height of 16"	10 M @	400 (16)					10 M @	400 (16)						

**NOTES:**

1.  $S_{a,ICF}$  is equivalent spectral response acceleration for ICF walls as provided in Appendix A.
2. This table is to be used in conjunction with the "Design Limitations."
3. Provide two layers of the indicated horizontal and vertical distributed steel specified for 300mm (12") walls. Place each layer as shown in the rebar placement drawing.
4. All four sides of the building are to have a minimum number and length of shear walls that conforms to this table.
5. Use Table A.6 for buildings that do not meet the required wall length of this table.
6. Provide 2-15M concentrated reinforcement at each end of shear walls as shown in shear wall detail.
7. All concentrated reinforcement is to be continued to the bottom of the foundation wall. Provide lap splices as required.
8. Concentrated reinforcement is to be placed in accordance with Bar Placement Detail.

**INSULATING CONCRETE FORMS MANUFACTURERS ASSOCIATION**

**Table A.4.3200. Above Grade Shear Wall Length for Seismic Zone Classification,  $S_{a,ICF} \leq 0.16$  and Hourly Wind Pressure,  $0.5kPa < q1/50 \leq 0.75kPa$  (in a Building Without Walkout Basement), where Building Area  $\leq 3200ft^2$**

Wall Height m (ft)	Seismic Zone Classification											
	$S_{a,ICF} \leq 0.07$		$S_{a,ICF} \leq 0.11$		$S_{a,ICF} \leq 0.16$							
<b>Second Floor Walls of Two Story ICF Structure Supporting Wood Frame Roof (TYPE A)</b>												
	6" & 8" Thick Wall		10" & 12" Thick Wall		6" & 8" Thick Wall		10" & 12" Thick Wall					
	Number and length of shear walls provided											
2.44 (8)	1 x 8'-0"	2 x 4'-0"	3 x 2'-8"	1 x 8'-0"	2 x 4'-0"	3 x 2'-8"	1 x 8'-0"	2 x 4'-0"	3 x 3'-0"	1 x 8'-0"	2 x 4'-0"	3 x 3'-0"
2.75 (9)	1 x 8'-0"	2 x 4'-0"	3 x 2'-8"	1 x 8'-0"	2 x 4'-0"	3 x 2'-8"	1 x 8'-0"	2 x 4'-0"	3 x 3'-0"	1 x 8'-0"	2 x 4'-0"	3 x 3'-0"
3.05 (10)	1 x 8'-0"	2 x 4'-0"	3 x 2'-8"	1 x 8'-0"	2 x 4'-0"	3 x 2'-8"	1 x 8'-0"	2 x 4'-0"	3 x 3'-0"	1 x 8'-0"	2 x 4'-0"	3 x 3'-0"
4.27 (14)	1 x 8'-0"	2 x 4'-0"	3 x 2'-8"	1 x 8'-0"	2 x 4'-0"	3 x 2'-8"	1 x 8'-0"	2 x 4'-6"	3 x 3'-6"	1 x 8'-0"	2 x 4'-6"	3 x 3'-6"
4.88 (16)	1 x 8'-0"	2 x 4'-0"	3 x 2'-8"	1 x 8'-0"	2 x 4'-0"	3 x 2'-8"	1 x 8'-0"	2 x 4'-6"	3 x 3'-6"	1 x 8'-0"	2 x 4'-6"	3 x 3'-6"
<b>Main Floor Walls of One Story ICF Structure Supporting Wood Frame Roof (TYPE B)</b>												
	6" & 8" Thick Wall		10" & 12" Thick Wall		6" & 8" Thick Wall		10" & 12" Thick Wall					
	Number and length of shear walls provided											
2.44 (8)	1 x 8'-0"	2 x 4'-0"	3 x 2'-8"	1 x 8'-0"	2 x 4'-0"	3 x 2'-8"	1 x 8'-0"	2 x 4'-0"	3 x 3'-0"	1 x 8'-0"	2 x 4'-0"	3 x 3'-0"
2.75 (9)	1 x 8'-0"	2 x 4'-0"	3 x 2'-8"	1 x 8'-0"	2 x 4'-0"	3 x 2'-8"	1 x 8'-0"	2 x 4'-0"	3 x 3'-0"	1 x 8'-0"	2 x 4'-0"	3 x 3'-0"
3.05 (10)	1 x 8'-0"	2 x 4'-0"	3 x 2'-8"	1 x 8'-0"	2 x 4'-0"	3 x 2'-8"	1 x 8'-0"	2 x 4'-0"	3 x 3'-0"	1 x 8'-0"	2 x 5'-0"	3 x 3'-6"
3.66 (12)	1 x 8'-0"	2 x 4'-0"	3 x 3'-0"	1 x 8'-0"	2 x 4'-0"	3 x 3'-0"	1 x 8'-0"	2 x 4'-6"	3 x 3'-6"	1 x 8'-0"	2 x 4'-6"	3 x 3'-6"
4.27 (14)	1 x 8'-0"	2 x 4'-0"	3 x 3'-0"	1 x 8'-0"	2 x 4'-0"	3 x 3'-0"	1 x 8'-0"	2 x 5'-0"	3 x 4'-0"	1 x 8'-0"	2 x 5'-6"	3 x 4'-0"
4.88 (16)	1 x 8'-0"	2 x 4'-0"	3 x 3'-0"	1 x 8'-0"	2 x 4'-0"	3 x 4'-0"	1 x 8'-0"	2 x 5'-0"	3 x 4'-0"	1 x 8'-0"	2 x 5'-6"	3 x 4'-0"
<b>Main Floor Walls of Two Story Structure Supporting 2nd Story Wood Framed Walls, Floor and Roof (TYPE C)</b>												
	6" & 8" Thick Wall		10" & 12" Thick Wall		6" & 8" Thick Wall		10" & 12" Thick Wall					
	Number and length of shear walls provided											
2.44 (8)	1 x 8'-0"	2 x 4'-6"	3 x 3'-6"	1 x 8'-0"	2 x 4'-0"	3 x 3'-0"	1 x 9'-0"	2 x 6'-0"	3 x 5'-0"	1 x 9'-0"	2 x 6'-6"	3 x 5'-0"
2.75 (9)	1 x 8'-0"	2 x 4'-6"	3 x 3'-6"	1 x 8'-0"	2 x 4'-6"	3 x 3'-6"	1 x 9'-0"	2 x 6'-6"	3 x 5'-0"	1 x 10'-0"	2 x 7'-0"	3 x 5'-0"
3.05 (10)	1 x 8'-0"	2 x 5'-0"	3 x 4'-0"	1 x 8'-0"	2 x 5'-0"	3 x 4'-0"	1 x 10'-0"	2 x 7'-4"	3 x 6'-0"	1 x 10'-0"	2 x 7'-4"	3 x 6'-0"
3.66 (12)	1 x 8'-6"	2 x 5'-6"	3 x 4'-0"	1 x 8'-6"	2 x 5'-6"	3 x 4'-0"	1 x 10'-6"	2 x 8'-4"	3 x 6'-6"	1 x 10'-6"	2 x 8'-4"	3 x 6'-6"
4.27 (14)	1 x 8'-6"	2 x 5'-6"	3 x 4'-6"	1 x 8'-6"	2 x 6'-0"	3 x 4'-6"	1 x 11'-0"	2 x 8'-6"	3 x 7'-0"	1 x 11'-6"	2 x 9'-0"	3 x 7'-0"
4.88 (16)	1 x 8'-6"	2 x 5'-6"	3 x 4'-6"	1 x 8'-6"	2 x 6'-0"	3 x 5'-0"	1 x 11'-0"	2 x 9'-0"	3 x 7'-6"	1 x 12'-0"	2 x 9'-6"	3 x 7'-6"
<b>Main Floor Walls of Two Story ICF Structure Supporting Wood Frame Floors and Roof (TYPE D)</b>												
	6" & 8" Thick Wall		10" & 12" Thick Wall		6" & 8" Thick Wall		10" & 12" Thick Wall					
	Number and length of shear walls provided											
2.44 (8)	1 x 9'-0"	2 x 5'-6"	3 x 4'-6"	1 x 9'-0"	2 x 5'-6"	3 x 4'-6"	1 x 11'-0"	2 x 7'-0"	3 x 5'-6"	1 x 12'-0"	2 x 8'-0"	3 x 6'-0"
2.75 (9)	1 x 9'-0"	2 x 6'-0"	3 x 4'-6"	1 x 10'-0"	2 x 6'-0"	3 x 5'-0"	1 x 12'-0"	2 x 7'-6"	3 x 6'-0"	1 x 13'-0"	2 x 8'-0"	3 x 6'-0"
3.05 (10)	1 x 9'-6"	2 x 6'-6"	3 x 5'-0"	1 x 10'-0"	2 x 6'-6"	3 x 5'-0"	1 x 13'-0"	2 x 8'-6"	3 x 6'-6"	1 x 13'-0"	2 x 8'-6"	3 x 7'-0"
3.66 (12)	1 x 10'-0"	2 x 7'-0"	3 x 5'-0"	1 x 10'-6"	2 x 7'-0"	3 x 5'-6"	1 x 13'-0"	2 x 9'-0"	3 x 7'-0"	1 x 13'-6"	2 x 9'-0"	3 x 7'-0"
4.27 (14)	1 x 10'-0"	2 x 7'-0"	3 x 5'-6"	1 x 11'-0"	2 x 7'-6"	3 x 6'-0"	1 x 13'-0"	2 x 9'-0"	3 x 7'-0"	1 x 14'-6"	2 x 9'-6"	3 x 8'-0"
4.88 (16)	1 x 10'-0"	2 x 7'-0"	3 x 5'-6"	1 x 11'-6"	2 x 7'-6"	3 x 6'-0"	1 x 13'-0"	2 x 9'-0"	3 x 7'-0"	1 x 14'-6"	2 x 10'-0"	3 x 8'-0"
Vertical Reinforcement	ICF with 6" Tie Spacing	As per table A.1.1.					As per table A.1.1.					
Vertical Reinforcement	ICF with 8" Tie Spacing	As per table A.1.2.					As per table A.1.2.					
Horizontal Reinforcement	Block Height of 12" and 18"	10 M @ 450 (18)		10 M @ 450 (18)		10 M @ 450 (18)		10 M @ 450 (18)		10 M @ 450 (18)		
Horizontal Reinforcement	Block Height of 16"	10 M @ 400 (16)		10 M @ 400 (16)		10 M @ 400 (16)		10 M @ 400 (16)		10 M @ 400 (16)		

**NOTES:**

1.  $S_{a,ICF}$  is equivalent spectral response acceleration for ICF walls as provided in Appendix A.
2. This table is to be used in conjunction with the "Design Limitations."
3. Provide two layers of the indicated horizontal and vertical distributed steel specified for 300mm (12") walls. Place each layer as shown in the rebar placement drawing.
4. All four sides of the building are to have a minimum number and length of shear walls that conforms to this table.
5. Use Table A.6 for buildings that do not meet the required wall length of this table.
6. Provide 2-15M concentrated reinforcement at each end of shear walls as shown in shear wall detail.
7. All concentrated reinforcement is to be continues to the bottom of the foundation wall. Provide lap splices as required.
8. Concentrated reinforcement is to be placed in accordance with Bar Placement Detail.

INSULATING CONCRETE FORMS  
MANUFACTURERS ASSOCIATION

**Table A.5.3200. Above Grade Shear Wall Length for Seismic Zone Classification,  $S_{a,ICF} \leq 0.16$  and Hourly Wind Pressure,  $0.5kPa < q1/50 \leq 0.75kPa$  (in a Building Without Walkout Basement), where Building Area  $\leq 3200ft^2$**

Wall Height m (ft)	Seismic Zone Classification																	
	$S_{a,ICF} \leq 0.07$		$S_{a,ICF} \leq 0.11$		$S_{a,ICF} \leq 0.16$													
<b>Second Floor Walls of Two Story ICF Structure Supporting Wood Frame Roof (TYPE A)</b>																		
	6" & 8" Thick Wall		10" & 12" Thick Wall		6" & 8" Thick Wall		10" & 12" Thick Wall											
	Number and length of shear walls provided																	
2.44 (8)	1 x 8'-0"	2 x 4'-0"	3 x 2'-8"	1 x 8'-0"	2 x 4'-0"	3 x 2'-8"	1 x 8'-0"	2 x 4'-0"	3 x 3'-0"	1 x 8'-0"	2 x 4'-0"	3 x 3'-0"	1 x 8'-0"	2 x 4'-6"	3 x 3'-6"	1 x 8'-0"	2 x 4'-0"	3 x 4'-0"
2.75 (9)	1 x 8'-0"	2 x 4'-0"	3 x 2'-8"	1 x 8'-0"	2 x 4'-0"	3 x 2'-8"	1 x 8'-0"	2 x 4'-0"	3 x 3'-0"	1 x 8'-0"	2 x 4'-0"	3 x 3'-0"	1 x 8'-0"	2 x 4'-6"	3 x 3'-6"	1 x 8'-0"	2 x 5'-0"	3 x 4'-0"
3.05 (10)	1 x 8'-0"	2 x 4'-0"	3 x 2'-8"	1 x 8'-0"	2 x 4'-0"	3 x 2'-8"	1 x 8'-0"	2 x 4'-6"	3 x 3'-6"	1 x 8'-0"	2 x 4'-6"	3 x 3'-6"	1 x 9'-0"	2 x 6'-0"	3 x 4'-6"	1 x 9'-0"	2 x 6'-0"	3 x 4'-8"
3.66 (12)	1 x 8'-0"	2 x 4'-0"	3 x 3'-0"	1 x 8'-0"	2 x 4'-0"	3 x 3'-0"	1 x 8'-0"	2 x 4'-6"	3 x 3'-6"	1 x 8'-0"	2 x 4'-6"	3 x 3'-6"	1 x 9'-0"	2 x 6'-0"	3 x 4'-6"	1 x 9'-0"	2 x 6'-0"	3 x 4'-6"
4.27 (14)	1 x 8'-0"	2 x 4'-0"	3 x 3'-0"	1 x 8'-0"	2 x 4'-0"	3 x 3'-0"	1 x 8'-0"	2 x 5'-0"	3 x 4'-0"	1 x 8'-0"	2 x 5'-0"	3 x 4'-0"	1 x 9'-4"	2 x 6'-0"	3 x 5'-0"	1 x 10'-0"	2 x 7'-0"	3 x 5'-6"
4.88 (16)	1 x 8'-0"	2 x 4'-0"	3 x 3'-0"	1 x 8'-0"	2 x 5'-0"	3 x 4'-0"	1 x 8'-0"	2 x 5'-0"	3 x 4'-0"	1 x 8'-0"	2 x 5'-0"	3 x 4'-0"	1 x 9'-0"	2 x 6'-0"	3 x 5'-0"	1 x 10'-0"	2 x 7'-6"	3 x 6'-0"
<b>Main Floor Walls of One Story ICF Structure Supporting Wood Frame Roof (TYPE B)</b>																		
	6" & 8" Thick Wall		10" & 12" Thick Wall		6" & 8" Thick Wall		10" & 12" Thick Wall											
	Number and length of shear walls provided																	
2.44 (8)	1 x 8'-0"	2 x 4'-0"	3 x 2'-8"	1 x 8'-0"	2 x 4'-0"	3 x 2'-8"	1 x 8'-0"	2 x 4'-0"	3 x 3'-0"	1 x 8'-0"	2 x 4'-0"	3 x 3'-0"	1 x 8'-0"	2 x 4'-6"	3 x 3'-6"	1 x 8'-0"	2 x 4'-0"	3 x 3'-0"
2.75 (9)	1 x 8'-0"	2 x 4'-0"	3 x 2'-8"	1 x 8'-0"	2 x 4'-0"	3 x 2'-8"	1 x 8'-0"	2 x 4'-0"	3 x 3'-0"	1 x 8'-0"	2 x 4'-0"	3 x 3'-0"	1 x 8'-0"	2 x 4'-6"	3 x 3'-6"	1 x 8'-0"	2 x 4'-6"	3 x 3'-6"
3.05 (10)	1 x 8'-0"	2 x 4'-0"	3 x 2'-8"	1 x 8'-0"	2 x 4'-0"	3 x 2'-8"	1 x 8'-0"	2 x 4'-6"	3 x 3'-6"	1 x 8'-0"	2 x 4'-6"	3 x 3'-6"	1 x 8'-0"	2 x 5'-0"	3 x 3'-6"	1 x 8'-0"	2 x 5'-0"	3 x 3'-6"
3.66 (12)	1 x 8'-0"	2 x 4'-0"	3 x 3'-0"	1 x 8'-0"	2 x 4'-0"	3 x 3'-0"	1 x 8'-0"	2 x 4'-6"	3 x 3'-6"	1 x 8'-0"	2 x 4'-6"	3 x 3'-6"	1 x 9'-0"	2 x 6'-0"	3 x 4'-6"	1 x 9'-0"	2 x 6'-0"	3 x 4'-6"
4.27 (14)	1 x 8'-0"	2 x 4'-0"	3 x 3'-0"	1 x 8'-0"	2 x 4'-0"	3 x 3'-0"	1 x 8'-0"	2 x 5'-0"	3 x 4'-0"	1 x 8'-0"	2 x 5'-0"	3 x 4'-0"	1 x 9'-4"	2 x 6'-0"	3 x 5'-0"	1 x 10'-0"	2 x 7'-0"	3 x 5'-6"
4.88 (16)	1 x 8'-0"	2 x 4'-0"	3 x 3'-0"	1 x 8'-0"	2 x 5'-0"	3 x 4'-0"	1 x 8'-0"	2 x 5'-0"	3 x 4'-0"	1 x 8'-0"	2 x 5'-0"	3 x 4'-0"	1 x 9'-0"	2 x 6'-0"	3 x 5'-0"	1 x 10'-0"	2 x 7'-6"	3 x 6'-0"
<b>Main Floor Walls of Two Story Structure Supporting 2nd Story Wood Framed Walls, Floor and Roof (TYPE C)</b>																		
	6" & 8" Thick Wall		10" & 12" Thick Wall		6" & 8" Thick Wall		10" & 12" Thick Wall											
	Number and length of shear walls provided																	
2.44 (8)	1 x 8'-0"	2 x 4'-6"	3 x 3'-6"	1 x 8'-0"	2 x 4'-0"	3 x 3'-0"	1 x 9'-0"	2 x 6'-0"	3 x 5'-0"	1 x 9'-0"	2 x 6'-6"	3 x 5'-0"	1 x 11'-6"	2 x 7'-6"	3 x 6'-0"	1 x 11'-6"	2 x 7'-0"	3 x 5'-6"
2.75 (9)	1 x 8'-0"	2 x 4'-6"	3 x 3'-6"	1 x 8'-0"	2 x 5'-0"	3 x 4'-0"	1 x 9'-0"	2 x 6'-6"	3 x 5'-0"	1 x 10'-0"	2 x 7'-0"	3 x 5'-0"	1 x 12'-0"	2 x 7'-6"	3 x 6'-0"	1 x 12'-0"	2 x 8'-0"	3 x 6'-0"
3.05 (10)	1 x 8'-0"	2 x 5'-0"	3 x 4'-0"	1 x 8'-0"	2 x 5'-0"	3 x 4'-0"	1 x 10'-0"	2 x 7'-4"	3 x 6'-0"	1 x 10'-0"	2 x 7'-4"	3 x 6'-0"	1 x 12'-6"	2 x 8'-6"	3 x 6'-6"	1 x 12'-6"	2 x 8'-0"	3 x 6'-6"
3.66 (12)	1 x 8'-6"	2 x 5'-6"	3 x 4'-0"	1 x 8'-6"	2 x 5'-6"	3 x 4'-0"	1 x 10'-6"	2 x 8'-4"	3 x 6'-6"	1 x 10'-6"	2 x 8'-4"	3 x 6'-6"	1 x 13'-0"	2 x 9'-0"	3 x 7'-0"	1 x 13'-0"	2 x 9'-0"	3 x 7'-0"
4.27 (14)	1 x 8'-6"	2 x 5'-6"	3 x 4'-6"	1 x 8'-6"	2 x 6'-0"	3 x 4'-6"	1 x 11'-0"	2 x 8'-6"	3 x 7'-0"	1 x 11'-6"	2 x 9'-0"	3 x 7'-0"	1 x 13'-0"	2 x 9'-0"	3 x 7'-0"	1 x 14'-0"	2 x 10'-0"	3 x 7'-6"
4.88 (16)	1 x 8'-6"	2 x 5'-6"	3 x 4'-6"	1 x 9'-0"	2 x 6'-0"	3 x 5'-0"	1 x 11'-0"	2 x 9'-0"	3 x 7'-6"	1 x 12'-0"	2 x 9'-6"	3 x 7'-6"	1 x 13'-0"	2 x 9'-0"	3 x 7'-6"	1 x 14'-6"	2 x 10'-0"	3 x 7'-6"
<b>Main Floor Walls of Two Story ICF Structure Supporting Wood Frame Floors and Roof (TYPE D)</b>																		
	6" & 8" Thick Wall		10" & 12" Thick Wall		6" & 8" Thick Wall		10" & 12" Thick Wall											
	Number and length of shear walls provided																	
2.44 (8)	1 x 9'-0"	2 x 5'-6"	3 x 4'-6"	1 x 9'-0"	2 x 5'-6"	3 x 4'-6"	1 x 11'-0"	2 x 7'-6"	3 x 6'-0"	1 x 12'-0"	2 x 8'-0"	3 x 6'-0"	1 x 14'-0"	2 x 9'-0"	3 x 7'-0"	1 x 16'-0"	2 x 10'-0"	3 x 8'-0"
2.75 (9)	1 x 9'-0"	2 x 6'-0"	3 x 4'-6"	1 x 10'-0"	2 x 6'-6"	3 x 5'-0"	1 x 12'-0"	2 x 7'-6"	3 x 6'-0"	1 x 13'-0"	2 x 8'-6"	3 x 6'-6"	1 x 15'-0"	2 x 9'-6"	3 x 8'-0"	1 x 16'-0"	2 x 11'-0"	3 x 8'-0"
3.05 (10)	1 x 9'-6"	2 x 6'-6"	3 x 5'-0"	1 x 10'-0"	2 x 6'-6"	3 x 5'-0"	1 x 13'-0"	2 x 8'-6"	3 x 6'-6"	1 x 13'-0"	2 x 8'-6"	3 x 7'-0"	1 x 15'-6"	2 x 10'-6"	3 x 8'-0"	1 x 17'-0"	2 x 11'-0"	3 x 8'-6"
3.66 (12)	1 x 10'-0"	2 x 7'-0"	3 x 5'-0"	1 x 10'-6"	2 x 7'-0"	3 x 5'-6"	1 x 13'-6"	2 x 9'-0"	3 x 7'-0"	1 x 13'-6"	2 x 9'-0"	3 x 7'-0"	1 x 16'-0"	2 x 11'-0"	3 x 9'-0"	1 x 17'-0"	2 x 11'-0"	3 x 9'-0"
4.27 (14)	1 x 10'-0"	2 x 7'-0"	3 x 5'-6"	1 x 11'-0"	2 x 7'-6"	3 x 6'-0"	1 x 13'-0"	2 x 9'-0"	3 x 7'-0"	1 x 14'-6"	2 x 9'-6"	3 x 8'-0"	1 x 16'-0"	2 x 11'-0"	3 x 9'-0"	1 x 18'-0"	2 x 12'-0"	3 x 10'-0"
4.88 (16)	1 x 10'-0"	2 x 7'-0"	3 x 5'-6"	1 x 11'-6"	2 x 7'-6"	3 x 6'-0"	1 x 13'-0"	2 x 9'-0"	3 x 7'-0"	1 x 14'-6"	2 x 10'-0"	3 x 8'-0"	1 x 16'-0"	2 x 11'-0"	3 x 9'-0"	1 x 18'-0"	2 x 12'-6"	3 x 10'-0"
Vertical Reinforcement	ICF with 6" Tie Spacing	As per table A.1.1.				As per table A.1.1.				As per table A.1.1.								
Vertical Reinforcement	ICF with 8" Tie Spacing	As per table A.1.2.				As per table A.1.2.				As per table A.1.2.								
Horizontal Reinforcement	Block Height of 12" and 18"	10 M @ 450 (18)				10 M @ 450 (18)				10 M @ 450 (18)								
Horizontal Reinforcement	Block Height of 16"	10 M @ 400 (16)				10 M @ 400 (16)				10 M @ 400 (16)								

**NOTES:**

1.  $S_{a,ICF}$  is equivalent spectral response acceleration for ICF walls as provided in Appendix A.
2. This table is to be used in conjunction with the "Design Limitations."
3. Provide two layers of the indicated horizontal and vertical distributed steel specified for 300mm (12") walls. Place each layer as shown in the rebar placement drawing.
4. All four sides of the building are to have a minimum number and length of shear walls that conforms to this table.
5. Use Table A.6 for buildings that do not meet the required wall length of this table.
6. Provide 2-15M concentrated reinforcement at each end of shear walls as shown in shear wall detail.
7. All concentrated reinforcement is to be continues to the bottom of the foundation wall. Provide lap splices as required.
8. Concentrated reinforcement is to be placed in accordance with Bar Placement Detail.

INSULATING CONCRETE FORMS MANUFACTURERS ASSOCIATION

**Table A.6.3200. Above Grade Shear Wall Length for Seismic Zone Classification,  $S_{a,ICF} > 0.16$  and Hourly Wind Pressure,  $q_{1/50} \leq 1.05\text{kPa}$  (in a Building Without Walkout Basement), where Building Area  $\leq 3200\text{ft}^2$**

Wall HC49AB87		Seismic Zone Classification																										
		$S_{a,ICF} \leq 0.16$		$S_{a,ICF} \leq 0.31$		$S_{a,ICF} \leq 0.53$		$S_{a,ICF} \leq 0.79$																				
<b>Second Floor Walls of Two Story ICF Structure Supporting Wood Frame Roof (TYPE A)</b>		6" & 8" Thick Wall		10" & 12" Thick Wall		6" & 8" Thick Wall		10" & 12" Thick Wall		6" & 8" Thick Wall		10" & 12" Thick Wall																
		Number and length of shear walls provided																										
2.44 (8)		1x8'-0"	2x4'-0"	3x3'-0"	1x8'-0"	2x4'-0"	3x3'-0"	1x8'-0"	2x5'-0"	3x4'-0"	1x8'-0"	2x5'-0"	3x4'-0"	1x10'-0"	2x7'-0"	3x6'-0"	1x10'-0"	2x7'-0"	3x6'-0"	1x11'-0"	2x8'-0"	3x6'-0"	1x13'-0"	2x9'-0"	3x7'-0"	1x13'-0"	2x9'-0"	3x7'-0"
2.75 (9)		1x8'-0"	2x4'-0"	3x3'-0"	1x8'-0"	2x4'-0"	3x3'-0"	1x8'-0"	2x5'-0"	3x4'-0"	1x8'-0"	2x5'-0"	3x4'-0"	1x11'-0"	2x7'-0"	3x6'-0"	1x11'-0"	2x8'-0"	3x6'-0"	1x11'-0"	2x8'-0"	3x6'-0"	1x13'-0"	2x9'-0"	3x7'-0"	1x13'-0"	2x9'-0"	3x7'-0"
3.05 (10)		1x8'-0"	2x4'-0"	3x3'-0"	1x8'-0"	2x4'-0"	3x3'-0"	1x8'-0"	2x5'-0"	3x4'-0"	1x8'-0"	2x5'-0"	3x4'-0"	1x12'-0"	2x8'-0"	3x7'-0"	1x12'-0"	2x8'-0"	3x7'-0"	1x12'-0"	2x8'-0"	3x7'-0"	1x14'-0"	2x10'-0"	3x8'-0"	1x14'-0"	2x10'-0"	3x8'-0"
3.66 (12)		1x8'-0"	2x4'-0"	3x3'-0"	1x8'-0"	2x4'-0"	3x3'-0"	1x8'-0"	2x5'-0"	3x4'-0"	1x8'-0"	2x5'-0"	3x4'-0"	1x13'-0"	2x8'-0"	3x7'-0"	1x13'-0"	2x8'-0"	3x7'-0"	1x13'-0"	2x8'-0"	3x7'-0"	1x15'-0"	2x10'-0"	3x8'-0"	1x15'-0"	2x10'-0"	3x8'-0"
4.27 (14)		1x8'-0"	2x5'-0"	3x4'-0"	1x8'-0"	2x5'-0"	3x4'-0"	1x11'-0"	2x7'-0"	3x6'-0"	1x11'-0"	2x7'-0"	3x6'-0"	1x14'-0"	2x10'-0"	3x8'-0"	1x14'-0"	2x10'-0"	3x8'-0"	1x14'-0"	2x10'-0"	3x8'-0"	1x16'-0"	2x11'-0"	3x9'-0"	1x16'-0"	2x11'-0"	3x9'-0"
4.88 (16)		1x8'-0"	2x5'-0"	3x4'-0"	1x8'-0"	2x5'-0"	3x4'-0"	1x11'-0"	2x8'-0"	3x7'-0"	1x12'-0"	2x8'-0"	3x8'-0"	1x15'-0"	2x11'-0"	3x9'-0"	1x15'-0"	2x11'-0"	3x9'-0"	1x15'-0"	2x11'-0"	3x9'-0"	1x18'-0"	2x13'-0"	3x10'-0"	1x18'-0"	2x13'-0"	3x10'-0"
<b>Main Floor Walls of One Story ICF Structure Supporting Wood Frame Roof (TYPE B)</b>		6" & 8" Thick Wall		10" & 12" Thick Wall		6" & 8" Thick Wall		10" & 12" Thick Wall		6" & 8" Thick Wall		10" & 12" Thick Wall		6" & 8" Thick Wall		10" & 12" Thick Wall		6" & 8" Thick Wall		10" & 12" Thick Wall		6" & 8" Thick Wall		10" & 12" Thick Wall				
		Number and length of shear walls provided																										
2.44 (8)		1x8'-0"	2x4'-0"	3x3'-0"	1x8'-0"	2x4'-0"	3x3'-0"	1x8'-0"	2x5'-0"	3x4'-0"	1x8'-0"	2x5'-0"	3x4'-0"	1x9'-0"	2x6'-0"	3x4'-0"	1x9'-0"	2x6'-0"	3x4'-0"	1x9'-0"	2x6'-0"	3x4'-0"	1x10'-0"	2x7'-0"	3x5'-0"	1x10'-0"	2x7'-0"	3x5'-0"
2.75 (9)		1x8'-0"	2x4'-0"	3x3'-0"	1x8'-0"	2x4'-0"	3x3'-0"	1x8'-0"	2x5'-0"	3x4'-0"	1x8'-0"	2x5'-0"	3x4'-0"	1x10'-0"	2x7'-0"	3x5'-0"	1x10'-0"	2x7'-0"	3x5'-0"	1x10'-0"	2x7'-0"	3x5'-0"	1x11'-0"	2x8'-0"	3x6'-0"	1x11'-0"	2x8'-0"	3x6'-0"
3.05 (10)		1x8'-0"	2x4'-0"	3x3'-0"	1x8'-0"	2x4'-0"	3x3'-0"	1x8'-0"	2x5'-0"	3x4'-0"	1x8'-0"	2x5'-0"	3x4'-0"	1x11'-0"	2x7'-0"	3x6'-0"	1x11'-0"	2x7'-0"	3x6'-0"	1x11'-0"	2x7'-0"	3x6'-0"	1x12'-0"	2x8'-0"	3x7'-0"	1x12'-0"	2x8'-0"	3x7'-0"
3.66 (12)		1x8'-0"	2x4'-0"	3x3'-0"	1x8'-0"	2x4'-0"	3x3'-0"	1x8'-0"	2x5'-0"	3x4'-0"	1x8'-0"	2x5'-0"	3x4'-0"	1x13'-0"	2x8'-0"	3x7'-0"	1x13'-0"	2x8'-0"	3x7'-0"	1x13'-0"	2x8'-0"	3x7'-0"	1x15'-0"	2x10'-0"	3x8'-0"	1x15'-0"	2x10'-0"	3x8'-0"
4.27 (14)		1x8'-0"	2x5'-0"	3x4'-0"	1x8'-0"	2x5'-0"	3x4'-0"	1x11'-0"	2x7'-0"	3x6'-0"	1x11'-0"	2x7'-0"	3x6'-0"	1x14'-0"	2x10'-0"	3x8'-0"	1x14'-0"	2x10'-0"	3x8'-0"	1x14'-0"	2x10'-0"	3x8'-0"	1x16'-0"	2x11'-0"	3x9'-0"	1x16'-0"	2x11'-0"	3x9'-0"
4.88 (16)		1x8'-0"	2x5'-0"	3x4'-0"	1x8'-0"	2x5'-0"	3x4'-0"	1x11'-0"	2x8'-0"	3x7'-0"	1x12'-0"	2x8'-0"	3x8'-0"	1x15'-0"	2x11'-0"	3x9'-0"	1x15'-0"	2x11'-0"	3x9'-0"	1x15'-0"	2x11'-0"	3x9'-0"	1x18'-0"	2x13'-0"	3x10'-0"	1x18'-0"	2x13'-0"	3x10'-0"
<b>Main Floor Walls of Two Story Structure Supporting 2nd Story Wood Framed Walls, Floor and Roof (TYPE C)</b>		6" & 8" Thick Wall		10" & 12" Thick Wall		6" & 8" Thick Wall		10" & 12" Thick Wall		6" & 8" Thick Wall		10" & 12" Thick Wall		6" & 8" Thick Wall		10" & 12" Thick Wall		6" & 8" Thick Wall		10" & 12" Thick Wall		6" & 8" Thick Wall		10" & 12" Thick Wall				
		Number and length of shear walls provided																										
2.44 (8)		1x9'-0"	2x6'-0"	3x5'-0"	1x9'-0"	2x6'-0"	3x5'-0"	1x13'-0"	2x9'-0"	3x6'-0"	1x13'-0"	2x9'-0"	3x6'-0"	1x17'-0"	2x11'-0"	3x9'-0"	1x17'-0"	2x11'-0"	3x9'-0"	1x17'-0"	2x11'-0"	3x9'-0"	1x17'-0"	2x12'-0"	3x9'-0"	1x17'-0"	2x12'-0"	3x10'-0"
2.75 (9)		1x9'-0"	2x6'-0"	3x5'-0"	1x9'-0"	2x6'-0"	3x5'-0"	1x14'-0"	2x10'-0"	3x7'-0"	1x14'-0"	2x10'-0"	3x7'-0"	1x17'-0"	2x11'-0"	3x9'-0"	1x17'-0"	2x11'-0"	3x9'-0"	1x17'-0"	2x11'-0"	3x9'-0"	1x18'-0"	2x13'-0"	3x10'-0"	1x18'-0"	2x13'-0"	3x10'-0"
3.05 (10)		1x10'-0"	2x6'-6"	3x5'-0"	1x10'-0"	2x6'-6"	3x5'-0"	1x15'-0"	2x10'-0"	3x8'-0"	1x15'-0"	2x10'-0"	3x8'-0"	1x17'-0"	2x12'-0"	3x10'-0"	1x17'-0"	2x12'-0"	3x10'-0"	1x17'-0"	2x12'-0"	3x10'-0"	1x19'-0"	2x13'-0"	3x11'-0"	1x19'-0"	2x13'-0"	3x11'-0"
3.66 (12)		1x10'-0"	2x7'-0"	3x6'-0"	1x11'-0"	2x7'-6"	3x6'-0"	1x15'-0"	2x10'-0"	3x9'-0"	1x15'-0"	2x10'-0"	3x9'-0"	1x19'-0"	2x13'-0"	3x11'-0"	1x19'-0"	2x13'-0"	3x11'-0"	1x19'-0"	2x13'-0"	3x11'-0"	1x21'-0"	2x14'-0"	3x12'-0"	1x21'-0"	2x14'-0"	3x12'-0"
4.27 (14)		1x11'-0"	2x7'-6"	3x6'-0"	1x11'-0"	2x7'-6"	3x6'-0"	1x16'-0"	2x11'-0"	3x10'-0"	1x16'-0"	2x11'-0"	3x10'-0"	1x20'-0"	2x14'-0"	3x11'-0"	1x20'-0"	2x14'-0"	3x11'-0"	1x20'-0"	2x14'-0"	3x11'-0"	1x22'-0"	2x16'-0"	3x13'-0"	1x22'-0"	2x16'-0"	3x13'-0"
4.88 (16)		1x11'-0"	2x7'-6"	3x6'-0"	1x11'-0"	2x7'-6"	3x6'-0"	1x16'-0"	2x12'-0"	3x10'-0"	1x16'-0"	2x12'-0"	3x10'-0"	1x21'-0"	2x14'-0"	3x11'-0"	1x21'-0"	2x14'-0"	3x11'-0"	1x21'-0"	2x14'-0"	3x11'-0"	1x24'-0"	2x17'-0"	3x13'-0"	1x24'-0"	2x17'-0"	3x13'-0"
<b>Main Floor Walls of Two Story ICF Structure Supporting Wood Frame Floors and Roof (TYPE D)</b>		6" & 8" Thick Wall		10" & 12" Thick Wall		6" & 8" Thick Wall		10" & 12" Thick Wall		6" & 8" Thick Wall		10" & 12" Thick Wall		6" & 8" Thick Wall		10" & 12" Thick Wall		6" & 8" Thick Wall		10" & 12" Thick Wall		6" & 8" Thick Wall		10" & 12" Thick Wall				
		Number and length of shear walls provided																										
2.44 (8)		1x11'-0"	2x7'-6"	3x5'-6"	1x12'-0"	2x7'-6"	3x6'-0"	1x16'-0"	2x11'-0"	3x8'-6"	1x17'-0"	2x11'-0"	3x9'-0"	1x19'-0"	2x13'-6"	3x11'-0"	1x20'-0"	2x14'-0"	3x11'-0"	1x20'-0"	2x14'-0"	3x11'-0"	1x21'-0"	2x15'-0"	3x12'-0"	1x22'-0"	2x16'-0"	3x13'-0"
2.75 (9)		1x12'-0"	2x8'-0"	3x6'-0"	1x12'-0"	2x8'-0"	3x6'-0"	1x17'-0"	2x12'-0"	3x9'-0"	1x17'-0"	2x12'-0"	3x9'-0"	1x20'-0"	2x14'-0"	3x11'-0"	1x20'-0"	2x14'-0"	3x11'-0"	1x20'-0"	2x14'-0"	3x11'-0"	1x22'-0"	2x16'-0"	3x13'-0"	1x23'-0"	2x17'-0"	3x13'-0"
3.05 (10)		1x12'-0"	2x8'-0"	3x6'-0"	1x13'-0"	2x8'-6"	3x6'-6"	1x18'-0"	2x12'-0"	3x9'-0"	1x18'-0"	2x12'-0"	3x9'-0"	1x21'-0"	2x15'-0"	3x12'-0"	1x21'-0"	2x15'-0"	3x12'-0"	1x21'-0"	2x15'-0"	3x12'-0"	1x24'-0"	2x18'-0"	3x14'-0"	1x24'-0"	2x18'-0"	3x14'-0"
3.66 (12)		1x12'-0"	2x8'-6"	3x7'-0"	1x14'-0"	2x10'-0"	3x7'-6"	1x19'-0"	2x12'-0"	3x10'-0"	1x20'-0"	2x13'-6"	3x11'-0"	1x23'-0"	2x16'-0"	3x13'-0"	1x23'-0"	2x16'-0"	3x13'-0"	1x23'-0"	2x16'-0"	3x13'-0"	1x25'-0"	2x19'-0"	3x14'-0"	1x26'-0"	2x19'-0"	3x15'-0"
4.27 (14)		1x13'-0"	2x9'-0"	3x7'-0"	1x13'-0"	2x10'-0"	3x7'-6"	1x19'-0"	2x13'-0"	3x11'-0"	1x20'-0"	2x13'-6"	3x11'-0"	1x24'-0"	2x17'-0"	3x14'-0"	1x25'-0"	2x17'-0"	3x14'-0"	1x25'-0"	2x17'-0"	3x14'-0"	1x27'-0"	2x20'-0"	3x15'-0"	1x28'-0"	2x21'-0"	3x16'-0"
4.88 (16)		1x13'-0"	2x9'-0"	3x7'-0"	1x14'-0"	2x10'-0"	3x8'-0"	1x19'-0"	2x13'-0"	3x11'-0"	1x20'-0"	2x14'-0"	3x11'-0"	1x24'-0"	2x17'-0"	3x14'-0"	1x26'-0"	2x19'-0"	3x15'-0"	1x26'-0"	2x19'-0"	3x15'-0"	1x28'-0"	2x22'-0"	3x16'-0"	1x29'-0"	2x22'-0"	3x17'-0"
Vertical	ICF with 6" The Spacing	As per table A.2.1.		As per table A.2.1.		As per table A.2.1.		As per table A.2.1.		As per table A.2.1.		As per table A.2.1.		As per table A.2.1.		As per table A.2.1.		As per table A.2.1.		As per table A.2.1.		As per table A.2.1.		As per table A.2.1.		As per table A.2.1.		
Reinforcement	ICF with 8" The Spacing	As per table A.2.2.		As per table A.2.2.		As per table A.2.2.		As per table A.2.2.		As per table A.2.2.		As per table A.2.2.		As per table A.2.2.		As per table A.2.2.		As per table A.2.2.		As per table A.2.2.		As per table A.2.2.		As per table A.2.2.		As per table A.2.2.		
Horizontal	Block Height of 12" and 18"	As per table A.2.1.		As per table A.2.1.		As per table A.2.1.		As per table A.2.1.		As per table A.2.1.		As per table A.2.1.		As per table A.2.1.		As per table A.2.1.		As per table A.2.1.		As per table A.2.1.		As per table A.2.1.		As per table A.2.1.		As per table A.2.1.		
Reinforcement	Block Height of 16"	As per table A.2.2.		As per table A.2.2.		As per table A.2.2.		As per table A.2.2.		As per table A.2.2.		As per table A.2.2.		As per table A.2.2.		As per table A.2.2.		As per table A.2.2.		As per table A.2.2.		As per table A.2.2.		As per table A.2.2.		As per table A.2.2.		

**NOTES:**

- $S_{a,ICF}$  is equivalent spectral response acceleration for ICF walls as provided in Appendix A.
- This table is to be used in conjunction with the "Design Limitations."
- Provide two layers of the indicated horizontal and vertical distributed steel specified for 300mm (12") walls. Place each layer as shown in the rebar placement drawing.
- All four sides of the building are to have a minimum number and length of shear walls that conforms to this table.
- Provide 2-15M concentrated reinforcement at each end of shear walls as shown in shear wall detail.
- All concentrated reinforcement is to be continues to the bottom of the foundation wall. Provide lap splices as required.
- Concentrated reinforcement is to be placed in accordance with Bar Placement Detail.
- Horizontal reinforcement in shear walls where  $S_{a,ICF} > 0.16$  must be anchored using a standard 180° hook around vertical end bars.
- When using this table for  $S_{a,ICF} \leq 0.16$ , use the vertical and horizontal distributed steel in Tables A.2.1. or A.2.2.

**INSULATING CONCRETE FORMS MANUFACTURERS ASSOCIATION**



**Table A.7.3200. Above Grade Shear Wall Length for Seismic Zone Classification,  $S_{a,ICF} \leq 0.16$  and Hourly Wind Pressure,  $q_{1/50} \leq 0.5kPa$  (in a Building With Walk Basement), where Building Area  $\leq 3200ft^2$**

Wall Height m (ft)	Seismic Zone Classification																	
	$S_{a,ICF} \leq 0.07$		$S_{a,ICF} \leq 0.11$		$S_{a,ICF} \leq 0.16$													
<b>Second Floor Walls of Two Story ICF Structure Supporting Wood Frame Roof (TYPE E)</b>																		
	6" & 8" Thick Wall		10" & 12" Thick Wall		6" & 8" Thick Wall		10" & 12" Thick Wall											
	Number and length of shear walls provided																	
2.44 (8)	1 x 8'-0"	2 x 4'-0"	3 x 2'-8"	1 x 8'-0"	2 x 4'-0"	3 x 2'-8"	1 x 8'-0"	2 x 4'-0"	3 x 3'-0"	1 x 8'-0"	2 x 4'-0"	3 x 3'-0"	1 x 8'-0"	2 x 4'-6"	3 x 4'-0"	1 x 8'-0"	2 x 5'-0"	3 x 4'-0"
2.75 (9)	1 x 8'-0"	2 x 4'-0"	3 x 2'-8"	1 x 8'-0"	2 x 4'-0"	3 x 2'-8"	1 x 8'-0"	2 x 4'-0"	3 x 3'-0"	1 x 8'-0"	2 x 4'-0"	3 x 3'-0"	1 x 8'-0"	2 x 4'-4"	3 x 3'-4"	1 x 8'-0"	2 x 5'-0"	3 x 4'-4"
3.05 (10)	1 x 8'-0"	2 x 4'-0"	3 x 2'-8"	1 x 8'-0"	2 x 4'-0"	3 x 2'-8"	1 x 8'-0"	2 x 4'-0"	3 x 3'-6"	1 x 8'-0"	2 x 4'-6"	3 x 3'-6"	1 x 8'-0"	2 x 4'-6"	3 x 4'-4"	1 x 9'-6"	2 x 5'-8"	3 x 4'-4"
3.66 (12)	1 x 8'-0"	2 x 4'-0"	3 x 3'-0"	1 x 8'-0"	2 x 4'-0"	3 x 3'-0"	1 x 8'-6"	2 x 5'-6"	3 x 4'-4"	1 x 8'-6"	2 x 5'-6"	3 x 4'-4"	1 x 10'-6"	2 x 7'-0"	3 x 5'-6"	1 x 11'-0"	2 x 7'-0"	3 x 5'-6"
4.27 (14)	1 x 8'-0"	2 x 4'-6"	3 x 4'-0"	1 x 8'-0"	2 x 5'-0"	3 x 4'-0"	1 x 10'-0"	2 x 6'-0"	3 x 4'-8"	1 x 10'-6"	2 x 7'-0"	3 x 5'-4"	1 x 11'-6"	2 x 7'-6"	3 x 6'-0"	1 x 12'-6"	2 x 8'-4"	3 x 6'-6"
4.88 (16)	1 x 8'-0"	2 x 5'-0"	3 x 4'-0"	1 x 9'-0"	2 x 5'-6"	3 x 4'-6"	1 x 10'-0"	2 x 6'-6"	3 x 5'-0"	1 x 11'-0"	2 x 7'-6"	3 x 5'-8"	1 x 12'-0"	2 x 8'-0"	3 x 6'-6"	1 x 14'-0"	2 x 9'-4"	3 x 7'-4"
<b>Main Floor Walls of One Story ICF Structure Supporting Wood Frame Roof (TYPE F)</b>																		
	6" & 8" Thick Wall		10" & 12" Thick Wall		6" & 8" Thick Wall		10" & 12" Thick Wall											
	Number and length of shear walls provided																	
2.44 (8)	1 x 8'-0"	2 x 4'-0"	3 x 2'-8"	1 x 8'-0"	2 x 4'-0"	3 x 2'-8"	1 x 8'-0"	2 x 4'-0"	3 x 3'-0"	1 x 8'-0"	2 x 4'-0"	3 x 3'-0"	1 x 8'-0"	2 x 4'-0"	3 x 3'-0"	1 x 8'-0"	2 x 4'-6"	3 x 3'-8"
2.75 (9)	1 x 8'-0"	2 x 4'-0"	3 x 2'-8"	1 x 8'-0"	2 x 4'-0"	3 x 2'-8"	1 x 8'-0"	2 x 4'-0"	3 x 3'-0"	1 x 8'-0"	2 x 4'-0"	3 x 3'-0"	1 x 8'-0"	2 x 4'-6"	3 x 3'-6"	1 x 8'-6"	2 x 5'-0"	3 x 3'-8"
3.05 (10)	1 x 8'-0"	2 x 4'-0"	3 x 2'-8"	1 x 8'-0"	2 x 4'-0"	3 x 2'-8"	1 x 8'-0"	2 x 4'-6"	3 x 3'-6"	1 x 8'-0"	2 x 4'-6"	3 x 3'-6"	1 x 8'-0"	2 x 4'-6"	3 x 4'-4"	1 x 9'-6"	2 x 5'-8"	3 x 4'-4"
3.66 (12)	1 x 8'-0"	2 x 4'-0"	3 x 3'-0"	1 x 8'-0"	2 x 4'-0"	3 x 3'-0"	1 x 8'-6"	2 x 5'-6"	3 x 4'-4"	1 x 8'-6"	2 x 5'-6"	3 x 4'-4"	1 x 10'-6"	2 x 7'-0"	3 x 5'-6"	1 x 11'-0"	2 x 7'-0"	3 x 5'-6"
4.27 (14)	1 x 8'-0"	2 x 4'-6"	3 x 4'-0"	1 x 8'-0"	2 x 5'-0"	3 x 4'-0"	1 x 10'-0"	2 x 6'-0"	3 x 4'-8"	1 x 10'-6"	2 x 7'-0"	3 x 5'-4"	1 x 11'-6"	2 x 7'-6"	3 x 6'-0"	1 x 12'-6"	2 x 8'-4"	3 x 6'-6"
4.88 (16)	1 x 8'-0"	2 x 5'-0"	3 x 4'-0"	1 x 9'-0"	2 x 5'-6"	3 x 4'-6"	1 x 10'-0"	2 x 6'-6"	3 x 5'-0"	1 x 11'-0"	2 x 7'-6"	3 x 5'-8"	1 x 12'-0"	2 x 8'-0"	3 x 6'-6"	1 x 14'-0"	2 x 9'-4"	3 x 7'-4"
<b>Main Floor Walls of Two Story Structure Supporting 2nd Story Wood Framed Walls, Floor and Roof (TYPE G)</b>																		
	6" & 8" Thick Wall		10" & 12" Thick Wall		6" & 8" Thick Wall		10" & 12" Thick Wall											
	Number and length of shear walls provided																	
2.44 (8)	1 x 8'-0"	2 x 5'-0"	3 x 4'-0"	1 x 8'-0"	2 x 5'-0"	3 x 4'-0"	1 x 10'-0"	2 x 6'-0"	3 x 5'-0"	1 x 10'-0"	2 x 6'-6"	3 x 5'-0"	1 x 12'-6"	2 x 8'-0"	3 x 6'-0"	1 x 13'-0"	2 x 8'-0"	3 x 6'-6"
2.75 (9)	1 x 8'-0"	2 x 5'-0"	3 x 4'-0"	1 x 8'-0"	2 x 5'-0"	3 x 4'-0"	1 x 10'-6"	2 x 6'-6"	3 x 5'-0"	1 x 11'-0"	2 x 7'-0"	3 x 5'-0"	1 x 13'-6"	2 x 8'-6"	3 x 6'-6"	1 x 13'-8"	2 x 9'-0"	3 x 7'-0"
3.05 (10)	1 x 8'-6"	2 x 5'-6"	3 x 4'-4"	1 x 8'-6"	2 x 5'-6"	3 x 4'-4"	1 x 11'-6"	2 x 7'-4"	3 x 6'-0"	1 x 11'-6"	2 x 7'-4"	3 x 6'-0"	1 x 14'-0"	2 x 9'-4"	3 x 7'-4"	1 x 14'-6"	2 x 9'-4"	3 x 7'-4"
3.66 (12)	1 x 9'-4"	2 x 6'-4"	3 x 5'-0"	1 x 9'-4"	2 x 6'-4"	3 x 5'-0"	1 x 12'-4"	2 x 8'-4"	3 x 6'-6"	1 x 12'-4"	2 x 8'-4"	3 x 6'-6"	1 x 15'-0"	2 x 10'-4"	3 x 8'-0"	1 x 15'-0"	2 x 10'-4"	3 x 8'-0"
4.27 (14)	1 x 9'-8"	2 x 6'-6"	3 x 5'-4"	1 x 10'-4"	2 x 7'-0"	3 x 5'-4"	1 x 12'-8"	2 x 8'-6"	3 x 7'-0"	1 x 13'-6"	2 x 9'-0"	3 x 7'-0"	1 x 15'-6"	2 x 10'-6"	3 x 8'-6"	1 x 16'-4"	2 x 11'-4"	3 x 9'-0"
4.88 (16)	1 x 10'-0"	2 x 7'-0"	3 x 5'-6"	1 x 11'-0"	2 x 7'-4"	3 x 5'-8"	1 x 13'-0"	2 x 9'-0"	3 x 7'-6"	1 x 14'-0"	2 x 9'-6"	3 x 7'-6"	1 x 15'-6"	2 x 10'-6"	3 x 8'-6"	1 x 17'-0"	2 x 11'-6"	3 x 9'-4"
<b>Main Floor Walls of Two Story ICF Structure Supporting Wood Frame Floors and Roof (TYPE H)</b>																		
	6" & 8" Thick Wall		10" & 12" Thick Wall		6" & 8" Thick Wall		10" & 12" Thick Wall											
	Number and length of shear walls provided																	
2.44 (8)	1 x 9'-4"	2 x 6'-0"	3 x 4'-6"	1 x 10'-0"	2 x 6'-4"	3 x 5'-0"	1 x 12'-6"	2 x 8'-0"	3 x 6'-0"	1 x 13'-4"	2 x 8'-6"	3 x 6'-6"	1 x 16'-0"	2 x 10'-0"	3 x 8'-0"	1 x 16'-6"	2 x 11'-0"	3 x 8'-6"
2.75 (9)	1 x 9'-8"	2 x 6'-6"	3 x 4'-8"	1 x 11'-0"	2 x 6'-6"	3 x 5'-0"	1 x 13'-0"	2 x 8'-4"	3 x 6'-6"	1 x 14'-0"	2 x 9'-0"	3 x 7'-0"	1 x 16'-6"	2 x 11'-0"	3 x 8'-6"	1 x 17'-6"	2 x 11'-6"	3 x 9'-0"
3.05 (10)	1 x 10'-4"	2 x 6'-6"	3 x 5'-0"	1 x 11'-0"	2 x 7'-0"	3 x 5'-6"	1 x 13'-8"	2 x 9'-0"	3 x 7'-0"	1 x 15'-0"	2 x 9'-6"	3 x 7'-6"	1 x 17'-6"	2 x 11'-6"	3 x 9'-0"	1 x 18'-6"	2 x 12'-0"	3 x 9'-6"
3.66 (12)	1 x 11'-6"	2 x 7'-6"	3 x 6'-0"	1 x 11'-6"	2 x 7'-6"	3 x 6'-0"	1 x 14'-6"	2 x 10'-0"	3 x 7'-8"	1 x 15'-0"	2 x 10'-0"	3 x 7'-8"	1 x 18'-0"	2 x 12'-4"	3 x 9'-8"	1 x 19'-0"	2 x 12'-4"	3 x 9'-8"
4.27 (14)	1 x 11'-6"	2 x 8'-0"	3 x 6'-6"	1 x 12'-6"	2 x 8'-6"	3 x 7'-0"	1 x 15'-0"	2 x 10'-0"	3 x 8'-0"	1 x 16'-6"	2 x 11'-0"	3 x 9'-0"	1 x 18'-4"	2 x 12'-6"	3 x 10'-0"	1 x 21'-0"	2 x 13'-6"	3 x 11'-0"
4.88 (16)	1 x 11'-6"	2 x 8'-0"	3 x 6'-6"	1 x 13'-0"	2 x 9'-0"	3 x 7'-6"	1 x 15'-0"	2 x 10'-0"	3 x 8'-0"	1 x 17'-6"	2 x 12'-0"	3 x 9'-0"	1 x 18'-4"	2 x 12'-6"	3 x 10'-0"	1 x 21'-0"	2 x 14'-4"	3 x 11'-4"
Vertical Reinforcement	ICF with 6" Tie Spacing		As per table A.1.1.		As per table A.1.1.		As per table A.1.1.											
	ICF with 8" Tie Spacing		As per table A.1.2.		As per table A.1.2.		As per table A.1.2.											
Horizontal Reinforcement	Block Height of 12" and 18"		10 M @ 450 (18)		10 M @ 450 (18)		10 M @ 450 (18)											
	Block Height of 16"		10 M @ 400 (16)		10 M @ 400 (16)		10 M @ 400 (16)											

**NOTES:**

1.  $S_{a,ICF}$  is equivalent spectral response acceleration for ICF walls as provided in Appendix A.
2. This table is to be used in conjunction with the "Design Limitations."
3. Provide two layers of the indicated horizontal and vertical distributed steel specified for 300mm (12") walls. Place each layer as shown in the rebar placement drawing.
4. All four sides of the building are to have a minimum number and length of shear walls that conforms to this table.
5. Use Table A.6 for buildings that do not meet the required wall length of this table.
6. Provide 2-15M concentrated reinforcement at each end of shear walls as shown in shear wall detail.
7. All concentrated reinforcement is to be continues to the bottom of the foundation wall. Provide lap splices as required.
8. Concentrated reinforcement is to be placed in accordance with Bar Placement Detail.

INSULATING CONCRETE FORMS MANUFACTURERS ASSOCIATION

**Table A.8.3200. Above Grade Shear Wall Length for Seismic Zone Classification,  $S_{a,ICF} \leq 0.16$  and Hourly Wind Pressure,  $0.5kPa < q1/50 \leq 0.75kPa$  (in a Building With Walkout Basement), where Building Area  $\leq 3200ft^2$**

Wall Height m (ft)	Seismic Zone Classification					
	$S_{a,ICF} \leq 0.07$		$S_{a,ICF} \leq 0.11$		$S_{a,ICF} \leq 0.16$	
<b>Second Floor Walls of Two Story ICF Structure Supporting Wood Frame Roof (TYPE E)</b>						
	6" & 8" Thick Wall		10" & 12" Thick Wall		10" & 12" Thick Wall	
	Number and length of shear walls provided					
2.44 (8)	1 x 8'-0"	2 x 4'-0"	3 x 2'-8"	1 x 8'-0"	2 x 4'-0"	3 x 2'-8"
2.75 (9)	1 x 8'-0"	2 x 4'-0"	3 x 2'-8"	1 x 8'-0"	2 x 4'-0"	3 x 3'-0"
3.05 (10)	1 x 8'-0"	2 x 4'-0"	3 x 3'-0"	1 x 8'-0"	2 x 4'-0"	3 x 3'-0"
<b>Main Floor Walls of One Story ICF Structure Supporting Wood Frame Roof (TYPE F)</b>						
	6" & 8" Thick Wall		10" & 12" Thick Wall		10" & 12" Thick Wall	
	Number and length of shear walls provided					
2.44 (8)	1 x 8'-0"	2 x 4'-0"	3 x 2'-8"	1 x 8'-0"	2 x 4'-0"	3 x 2'-8"
2.75 (9)	1 x 8'-0"	2 x 4'-0"	3 x 2'-8"	1 x 8'-0"	2 x 4'-0"	3 x 3'-0"
3.05 (10)	1 x 8'-0"	2 x 4'-0"	3 x 2'-8"	1 x 8'-0"	2 x 4'-0"	3 x 3'-6"
3.66 (12)	1 x 8'-0"	2 x 4'-0"	3 x 3'-0"	1 x 8'-0"	2 x 4'-0"	3 x 4'-4"
4.27 (14)	1 x 8'-0"	2 x 4'-6"	3 x 4'-0"	1 x 8'-0"	2 x 5'-0"	3 x 4'-0"
4.88 (16)	1 x 8'-0"	2 x 5'-0"	3 x 4'-0"	1 x 9'-0"	2 x 5'-6"	3 x 4'-6"
<b>Main Floor Walls of Two Story Structure Supporting 2nd Story Wood Framed Walls, Floor and Roof (TYPE G)</b>						
	6" & 8" Thick Wall		10" & 12" Thick Wall		10" & 12" Thick Wall	
	Number and length of shear walls provided					
2.44 (8)	1 x 8'-0"	2 x 5'-0"	3 x 4'-0"	1 x 10'-4"	2 x 6'-8"	3 x 5'-4"
2.75 (9)	1 x 8'-0"	2 x 5'-0"	3 x 4'-0"	1 x 10'-6"	2 x 6'-8"	3 x 5'-0"
3.05 (10)	1 x 8'-8"	2 x 5'-8"	3 x 4'-4"	1 x 11'-6"	2 x 7'-6"	3 x 6'-0"
3.66 (12)	1 x 9'-4"	2 x 6'-4"	3 x 5'-0"	1 x 12'-4"	2 x 8'-4"	3 x 6'-6"
4.27 (14)	1 x 9'-8"	2 x 6'-6"	3 x 5'-4"	1 x 12'-8"	2 x 8'-6"	3 x 7'-0"
4.88 (16)	1 x 10'-0"	2 x 7'-0"	3 x 5'-6"	1 x 13'-0"	2 x 9'-0"	3 x 7'-6"
<b>Main Floor Walls of Two Story ICF Structure Supporting Wood Frame Floors and Roof (TYPE H)</b>						
	6" & 8" Thick Wall		10" & 12" Thick Wall		10" & 12" Thick Wall	
	Number and length of shear walls provided					
2.44 (8)	1 x 9'-4"	2 x 6'-0"	3 x 4'-8"	1 x 10'-0"	2 x 6'-4"	3 x 5'-0"
2.75 (9)	1 x 9'-8"	2 x 6'-6"	3 x 4'-8"	1 x 11'-0"	2 x 6'-6"	3 x 5'-0"
3.05 (10)	1 x 11'-0"	2 x 7'-0"	3 x 5'-6"	1 x 11'-0"	2 x 7'-0"	3 x 5'-6"
3.66 (12)	1 x 11'-6"	2 x 7'-6"	3 x 6'-0"	1 x 11'-6"	2 x 7'-6"	3 x 6'-0"
4.27 (14)	1 x 11'-6"	2 x 8'-0"	3 x 6'-6"	1 x 12'-6"	2 x 8'-6"	3 x 7'-0"
4.88 (16)	1 x 11'-6"	2 x 8'-0"	3 x 6'-6"	1 x 13'-0"	2 x 9'-0"	3 x 7'-6"
Vertical Reinforcement	ICF with 6" Tie Spacing		As per table A.1.1.		As per table A.1.1.	
Vertical Reinforcement	ICF with 8" Tie Spacing		As per table A.1.2.		As per table A.1.2.	
Horizontal Reinforcement	Block Height of 12" and 18"		10 M @ 450 (18)		10 M @ 450 (18)	
Horizontal Reinforcement	Block Height of 16"		10 M @ 400 (16)		10 M @ 400 (16)	

**NOTES:**

1.  $S_{a,ICF}$  is equivalent spectral response acceleration for ICF walls as provided in Appendix A.
2. This table is to be used in conjunction with the "Design Limitations."
3. Provide two layers of the indicated horizontal and vertical distributed steel specified for 300mm (12") walls. Place each layer as shown in the rebar placement drawing.
4. All four sides of the building are to have a minimum number and length of shear walls that conforms to this table.
5. Use Table A.6 for buildings that do not meet the required wall length of this table.
6. Provide 2-15M concentrated reinforcement at each end of shear walls as shown in shear wall detail.
7. All concentrated reinforcement is to be continues to the bottom of the foundation wall. Provide lap splices as required.
8. Concentrated reinforcement is to be placed in accordance with Bar Placement Detail.

**INSULATING CONCRETE FORMS MANUFACTURERS ASSOCIATION**

**Table A.9.3200. Above Grade Shear Wall Length for Seismic Zone Classification,  $S_{a,ICF} \leq 0.16$  and Hourly Wind Pressure,  $0.75kPa < q_{1/50} \leq 1.05kPa$  (in a Building With Walkout Basement), where Building Area  $\leq 3200ft^2$**

Wall Height m (ft)	Seismic Zone Classification					
	$S_{a,ICF} \leq 0.07$		$S_{a,ICF} \leq 0.11$		$S_{a,ICF} \leq 0.16$	
<b>Second Floor Walls of Two Story ICF Structure Supporting Wood Frame Roof (TYPE E)</b>						
	6" & 8" Thick Wall		10" & 12" Thick Wall		6" & 8" Thick Wall	
	Number and length of shear walls provided					
2.44 (8)	1 x 8'-0"	2 x 4'-0"	3 x 2'-8"	1 x 8'-0"	2 x 4'-0"	3 x 2'-8"
2.75 (9)	1 x 8'-0"	2 x 4'-0"	3 x 2'-8"	1 x 8'-0"	2 x 4'-0"	3 x 3'-0"
3.05 (10)	1 x 8'-0"	2 x 4'-0"	3 x 3'-0"	1 x 8'-0"	2 x 4'-0"	3 x 3'-6"
3.66 (12)	1 x 8'-0"	2 x 4'-0"	3 x 3'-0"	1 x 8'-0"	2 x 4'-0"	3 x 3'-6"
4.27 (14)	1 x 8'-0"	2 x 4'-6"	3 x 4'-0"	1 x 8'-0"	2 x 5'-0"	3 x 4'-0"
4.88 (16)	1 x 8'-0"	2 x 5'-0"	3 x 4'-0"	1 x 8'-0"	2 x 5'-0"	3 x 4'-0"
<b>Main Floor Walls of One Story ICF Structure Supporting Wood Frame Roof (TYPE F)</b>						
	6" & 8" Thick Wall		10" & 12" Thick Wall		6" & 8" Thick Wall	
	Number and length of shear walls provided					
2.44 (8)	1 x 8'-0"	2 x 4'-0"	3 x 2'-8"	1 x 8'-0"	2 x 4'-0"	3 x 2'-8"
2.75 (9)	1 x 8'-0"	2 x 4'-0"	3 x 2'-8"	1 x 8'-0"	2 x 4'-0"	3 x 3'-0"
3.05 (10)	1 x 8'-0"	2 x 4'-0"	3 x 2'-8"	1 x 8'-0"	2 x 4'-0"	3 x 3'-6"
3.66 (12)	1 x 8'-0"	2 x 4'-0"	3 x 3'-0"	1 x 8'-0"	2 x 4'-0"	3 x 3'-6"
4.27 (14)	1 x 8'-0"	2 x 4'-6"	3 x 4'-0"	1 x 8'-0"	2 x 5'-0"	3 x 4'-0"
4.88 (16)	1 x 8'-0"	2 x 5'-0"	3 x 4'-0"	1 x 8'-0"	2 x 5'-0"	3 x 4'-0"
<b>Main Floor Walls of Two Story Structure Supporting 2nd Story Wood Framed Walls, Floor and Roof (TYPE G)</b>						
	6" & 8" Thick Wall		10" & 12" Thick Wall		6" & 8" Thick Wall	
	Number and length of shear walls provided					
2.44 (8)	1 x 8'-0"	2 x 5'-0"	3 x 4'-0"	1 x 8'-0"	2 x 5'-0"	3 x 4'-0"
2.75 (9)	1 x 8'-0"	2 x 5'-0"	3 x 4'-0"	1 x 8'-0"	2 x 5'-0"	3 x 5'-0"
3.05 (10)	1 x 8'-0"	2 x 5'-0"	3 x 4'-0"	1 x 8'-0"	2 x 5'-0"	3 x 5'-0"
3.66 (12)	1 x 8'-0"	2 x 5'-8"	3 x 4'-4"	1 x 8'-0"	2 x 5'-8"	3 x 4'-4"
4.27 (14)	1 x 8'-0"	2 x 6'-4"	3 x 5'-0"	1 x 8'-0"	2 x 6'-4"	3 x 5'-0"
4.88 (16)	1 x 8'-0"	2 x 7'-0"	3 x 5'-6"	1 x 8'-0"	2 x 7'-0"	3 x 5'-6"
<b>Main Floor Walls of Two Story ICF Structure Supporting Wood Frame Floors and Roof (TYPE H)</b>						
	6" & 8" Thick Wall		10" & 12" Thick Wall		6" & 8" Thick Wall	
	Number and length of shear walls provided					
2.44 (8)	1 x 9'-4"	2 x 6'-0"	3 x 4'-8"	1 x 10'-0"	2 x 6'-4"	3 x 5'-0"
2.75 (9)	1 x 9'-4"	2 x 6'-0"	3 x 4'-8"	1 x 10'-0"	2 x 6'-4"	3 x 5'-4"
3.05 (10)	1 x 11'-0"	2 x 7'-0"	3 x 5'-6"	1 x 11'-0"	2 x 7'-0"	3 x 5'-6"
3.66 (12)	1 x 11'-6"	2 x 7'-6"	3 x 6'-0"	1 x 11'-6"	2 x 7'-6"	3 x 6'-0"
4.27 (14)	1 x 11'-6"	2 x 8'-0"	3 x 6'-6"	1 x 11'-6"	2 x 8'-0"	3 x 6'-6"
4.88 (16)	1 x 11'-6"	2 x 8'-0"	3 x 6'-6"	1 x 11'-6"	2 x 8'-0"	3 x 6'-6"
Vertical Reinforcement	ICF with 6" Tie Spacing	As per table A.1.1.			As per table A.1.1.	
Horizontal Reinforcement	ICF with 8" Tie Spacing	As per table A.1.2.			As per table A.1.2.	
	Block Height of 12" and 18"	10 M @ 450 (18)			10 M @ 450 (18)	
	Block Height of 16"	10 M @ 400 (16)			10 M @ 400 (16)	

**NOTES:**

1.  $S_{a,ICF}$  is equivalent spectral response acceleration for ICF walls as provided in Appendix A.
2. This table is to be used in conjunction with the "Design Limitations."
3. Provide two layers of the indicated horizontal and vertical distributed steel specified for 300mm (12") walls. Place each layer as shown in the rebar placement drawing.
4. All four sides of the building are to have a minimum number and length of shear walls that conforms to this table.
5. Use Table A.6 for buildings that do not meet the required wall length of this table.
6. Provide 2-15M concentrated reinforcement at each end of shear walls as shown in shear wall detail.
7. All concentrated reinforcement is to be continues to the bottom of the foundation wall. Provide lap splices as required.
8. Concentrated reinforcement is to be placed in accordance with Bar Placement Detail.

INSULATING CONCRETE FORMS MANUFACTURERS ASSOCIATION

**Table A.10.3200. Above Grade Shear Wall Length for Seismic Zone Classification,  $S_{a,ICF} > 0.16$  and Hourly Wind Pressure,  $q_{1/50} \leq 1.05kPa$  (in a Building With Walkout Basement), where Building Area  $\leq 3200ft^2$**

Wall Height m (ft)	Seismic Zone Classification							
	$S_{a,ICF} \leq 0.16$		$S_{a,ICF} \leq 0.31$		$S_{a,ICF} \leq 0.53$		$S_{a,ICF} \leq 0.79$	
<b>Second Floor Walls of Two Story ICF Structure Supporting Wood Frame Roof (TYPE E)</b>								
	6" & 8" Thick Wall	10" & 12" Thick Wall	6" & 8" Thick Wall	10" & 12" Thick Wall	6" & 8" Thick Wall	10" & 12" Thick Wall	6" & 8" Thick Wall	10" & 12" Thick Wall
	Number and length of shear walls provided							
2.44 (8)	1x 8'-0" 2x 4'-0" 3x 3'-0"	1x 8'-0" 2x 4'-0" 3x 3'-0"	1x 9'-0" 2x 6'-0" 3x 4'-6"	1x 9'-0" 2x 6'-0" 3x 4'-6"	1x 11'-0" 2x 7'-6" 3x 6'-0"	1x 11'-6" 2x 8'-0" 3x 6'-4"	1x 12'-6" 2x 8'-6" 3x 7'-0"	1x 12'-6" 2x 9'-0" 3x 7'-0"
2.75 (9)	1x 8'-0" 2x 4'-0" 3x 3'-0"	1x 8'-0" 2x 4'-0" 3x 3'-0"	1x 9'-0" 2x 6'-0" 3x 4'-6"	1x 10'-0" 2x 7'-0" 3x 5'-0"	1x 10'-0" 2x 7'-0" 3x 5'-0"	1x 12'-6" 2x 8'-6" 3x 7'-0"	1x 12'-6" 2x 9'-0" 3x 7'-0"	1x 13'-6" 2x 9'-6" 3x 7'-6"
3.05 (10)	1x 8'-0" 2x 4'-0" 3x 3'-0"	1x 8'-0" 2x 4'-0" 3x 3'-0"	1x 9'-0" 2x 6'-0" 3x 4'-6"	1x 10'-0" 2x 7'-0" 3x 5'-0"	1x 11'-6" 2x 8'-0" 3x 6'-0"	1x 12'-6" 2x 8'-6" 3x 7'-0"	1x 12'-6" 2x 9'-0" 3x 7'-0"	1x 13'-6" 2x 9'-6" 3x 7'-6"
3.65 (12)	1x 8'-0" 2x 4'-0" 3x 3'-0"	1x 8'-0" 2x 4'-0" 3x 3'-0"	1x 9'-0" 2x 6'-0" 3x 4'-6"	1x 10'-0" 2x 7'-0" 3x 5'-0"	1x 11'-6" 2x 8'-0" 3x 6'-0"	1x 12'-6" 2x 8'-6" 3x 7'-0"	1x 12'-6" 2x 9'-0" 3x 7'-0"	1x 13'-6" 2x 9'-6" 3x 7'-6"
4.27 (14)	1x 8'-0" 2x 4'-0" 3x 3'-0"	1x 8'-0" 2x 4'-0" 3x 3'-0"	1x 9'-0" 2x 6'-0" 3x 4'-6"	1x 10'-0" 2x 7'-0" 3x 5'-0"	1x 11'-6" 2x 8'-0" 3x 6'-0"	1x 12'-6" 2x 8'-6" 3x 7'-0"	1x 12'-6" 2x 9'-0" 3x 7'-0"	1x 13'-6" 2x 9'-6" 3x 7'-6"
4.88 (16)	1x 8'-0" 2x 4'-0" 3x 3'-0"	1x 8'-0" 2x 4'-0" 3x 3'-0"	1x 9'-0" 2x 6'-0" 3x 4'-6"	1x 10'-0" 2x 7'-0" 3x 5'-0"	1x 11'-6" 2x 8'-0" 3x 6'-0"	1x 12'-6" 2x 8'-6" 3x 7'-0"	1x 12'-6" 2x 9'-0" 3x 7'-0"	1x 13'-6" 2x 9'-6" 3x 7'-6"
<b>Main Floor Walls of One Story ICF Structure Supporting Wood Frame Roof (TYPE F)</b>								
	6" & 8" Thick Wall	10" & 12" Thick Wall	6" & 8" Thick Wall	10" & 12" Thick Wall	6" & 8" Thick Wall	10" & 12" Thick Wall	6" & 8" Thick Wall	10" & 12" Thick Wall
	Number and length of shear walls provided							
2.44 (8)	1x 8'-0" 2x 4'-0" 3x 3'-0"	1x 8'-0" 2x 4'-0" 3x 3'-0"	1x 9'-0" 2x 6'-0" 3x 4'-6"	1x 9'-0" 2x 6'-0" 3x 4'-6"	1x 11'-0" 2x 7'-6" 3x 5'-6"	1x 11'-6" 2x 8'-0" 3x 6'-0"	1x 12'-6" 2x 8'-6" 3x 6'-6"	1x 12'-6" 2x 8'-0" 3x 6'-6"
2.75 (9)	1x 8'-0" 2x 4'-0" 3x 3'-0"	1x 8'-0" 2x 4'-0" 3x 3'-0"	1x 9'-0" 2x 6'-0" 3x 4'-6"	1x 10'-0" 2x 7'-0" 3x 5'-0"	1x 10'-0" 2x 7'-0" 3x 5'-0"	1x 12'-6" 2x 8'-6" 3x 6'-6"	1x 12'-6" 2x 9'-0" 3x 7'-0"	1x 13'-6" 2x 9'-6" 3x 7'-6"
3.05 (10)	1x 8'-0" 2x 4'-0" 3x 3'-0"	1x 8'-0" 2x 4'-0" 3x 3'-0"	1x 9'-0" 2x 6'-0" 3x 4'-6"	1x 10'-0" 2x 7'-0" 3x 5'-0"	1x 11'-6" 2x 8'-0" 3x 6'-0"	1x 12'-6" 2x 8'-6" 3x 6'-6"	1x 12'-6" 2x 9'-0" 3x 7'-0"	1x 13'-6" 2x 9'-6" 3x 7'-6"
3.65 (12)	1x 8'-0" 2x 4'-0" 3x 3'-0"	1x 8'-0" 2x 4'-0" 3x 3'-0"	1x 9'-0" 2x 6'-0" 3x 4'-6"	1x 10'-0" 2x 7'-0" 3x 5'-0"	1x 11'-6" 2x 8'-0" 3x 6'-0"	1x 12'-6" 2x 8'-6" 3x 6'-6"	1x 12'-6" 2x 9'-0" 3x 7'-0"	1x 13'-6" 2x 9'-6" 3x 7'-6"
4.27 (14)	1x 8'-0" 2x 4'-0" 3x 3'-0"	1x 8'-0" 2x 4'-0" 3x 3'-0"	1x 9'-0" 2x 6'-0" 3x 4'-6"	1x 10'-0" 2x 7'-0" 3x 5'-0"	1x 11'-6" 2x 8'-0" 3x 6'-0"	1x 12'-6" 2x 8'-6" 3x 6'-6"	1x 12'-6" 2x 9'-0" 3x 7'-0"	1x 13'-6" 2x 9'-6" 3x 7'-6"
4.88 (16)	1x 8'-0" 2x 4'-0" 3x 3'-0"	1x 8'-0" 2x 4'-0" 3x 3'-0"	1x 9'-0" 2x 6'-0" 3x 4'-6"	1x 10'-0" 2x 7'-0" 3x 5'-0"	1x 11'-6" 2x 8'-0" 3x 6'-0"	1x 12'-6" 2x 8'-6" 3x 6'-6"	1x 12'-6" 2x 9'-0" 3x 7'-0"	1x 13'-6" 2x 9'-6" 3x 7'-6"
<b>Main Floor Walls of Two Story Structure Supporting 2nd Story Wood Framed Walls, Floor and Roof (TYPE G)</b>								
	6" & 8" Thick Wall	10" & 12" Thick Wall	6" & 8" Thick Wall	10" & 12" Thick Wall	6" & 8" Thick Wall	10" & 12" Thick Wall	6" & 8" Thick Wall	10" & 12" Thick Wall
	Number and length of shear walls provided							
2.44 (8)	1x 10'-0" 2x 6'-0" 3x 5'-0"	1x 10'-0" 2x 6'-0" 3x 5'-0"	1x 14'-0" 2x 9'-6" 3x 7'-6"	1x 14'-0" 2x 9'-6" 3x 7'-6"	1x 19'-0" 2x 13'-0" 3x 11'-0"	1x 19'-0" 2x 13'-0" 3x 11'-0"	1x 20'-0" 2x 14'-0" 3x 12'-0"	1x 20'-0" 2x 14'-0" 3x 12'-0"
2.75 (9)	1x 11'-0" 2x 7'-0" 3x 6'-0"	1x 11'-0" 2x 7'-0" 3x 6'-0"	1x 15'-0" 2x 10'-0" 3x 8'-0"	1x 15'-0" 2x 10'-0" 3x 8'-0"	1x 20'-0" 2x 14'-0" 3x 11'-0"	1x 20'-0" 2x 14'-0" 3x 11'-0"	1x 20'-0" 2x 14'-0" 3x 12'-0"	1x 20'-0" 2x 14'-0" 3x 12'-0"
3.05 (10)	1x 11'-0" 2x 7'-0" 3x 6'-0"	1x 11'-0" 2x 7'-0" 3x 6'-0"	1x 16'-0" 2x 11'-0" 3x 8'-6"	1x 16'-0" 2x 11'-0" 3x 8'-6"	1x 21'-0" 2x 14'-6" 3x 11'-6"	1x 21'-0" 2x 14'-6" 3x 11'-6"	1x 22'-0" 2x 15'-0" 3x 12'-0"	1x 22'-0" 2x 15'-0" 3x 12'-0"
3.65 (12)	1x 11'-0" 2x 7'-0" 3x 6'-0"	1x 11'-0" 2x 7'-0" 3x 6'-0"	1x 16'-0" 2x 11'-0" 3x 8'-6"	1x 16'-0" 2x 11'-0" 3x 8'-6"	1x 21'-0" 2x 14'-6" 3x 11'-6"	1x 21'-0" 2x 14'-6" 3x 11'-6"	1x 22'-0" 2x 15'-0" 3x 12'-0"	1x 22'-0" 2x 15'-0" 3x 12'-0"
4.27 (14)	1x 12'-6" 2x 8'-6" 3x 7'-0"	1x 13'-0" 2x 9'-0" 3x 7'-0"	1x 17'-6" 2x 12'-0" 3x 10'-0"	1x 17'-6" 2x 12'-0" 3x 10'-0"	1x 24'-0" 2x 16'-6" 3x 13'-0"	1x 24'-0" 2x 16'-6" 3x 13'-0"	1x 24'-0" 2x 16'-6" 3x 14'-0"	1x 24'-0" 2x 16'-6" 3x 14'-0"
4.88 (16)	1x 12'-6" 2x 8'-6" 3x 7'-0"	1x 13'-0" 2x 9'-0" 3x 7'-0"	1x 17'-6" 2x 12'-0" 3x 10'-0"	1x 17'-6" 2x 12'-0" 3x 10'-0"	1x 24'-0" 2x 16'-6" 3x 13'-0"	1x 24'-0" 2x 16'-6" 3x 13'-0"	1x 24'-0" 2x 16'-6" 3x 14'-0"	1x 24'-0" 2x 16'-6" 3x 14'-0"
<b>Main Floor Walls of Two Story ICF Structure Supporting Wood Frame Floors and Roof (TYPE H)</b>								
	6" & 8" Thick Wall	10" & 12" Thick Wall	6" & 8" Thick Wall	10" & 12" Thick Wall	6" & 8" Thick Wall	10" & 12" Thick Wall	6" & 8" Thick Wall	10" & 12" Thick Wall
	Number and length of shear walls provided							
2.44 (8)	1x 12'-0" 2x 8'-0" 3x 6'-6"	1x 12'-6" 2x 8'-6" 3x 6'-6"	1x 17'-0" 2x 12'-0" 3x 9'-0"	1x 18'-0" 2x 12'-0" 3x 9'-6"	1x 21'-0" 2x 15'-0" 3x 12'-0"	1x 22'-0" 2x 15'-0" 3x 12'-0"	1x 23'-0" 2x 16'-0" 3x 14'-0"	1x 24'-0" 2x 17'-0" 3x 14'-0"
2.75 (9)	1x 13'-0" 2x 9'-0" 3x 7'-0"	1x 13'-0" 2x 9'-0" 3x 7'-0"	1x 18'-0" 2x 13'-0" 3x 10'-0"	1x 20'-0" 2x 13'-0" 3x 10'-0"	1x 22'-0" 2x 15'-0" 3x 12'-0"	1x 23'-0" 2x 16'-0" 3x 13'-0"	1x 24'-0" 2x 17'-0" 3x 14'-0"	1x 25'-0" 2x 18'-0" 3x 14'-0"
3.05 (10)	1x 14'-0" 2x 9'-0" 3x 7'-0"	1x 14'-0" 2x 10'-0" 3x 7'-6"	1x 19'-0" 2x 13'-0" 3x 11'-0"	1x 20'-0" 2x 14'-0" 3x 11'-0"	1x 23'-0" 2x 16'-0" 3x 13'-0"	1x 24'-0" 2x 17'-0" 3x 14'-0"	1x 25'-0" 2x 18'-0" 3x 15'-0"	1x 27'-0" 2x 19'-0" 3x 15'-0"
3.65 (12)	1x 14'-0" 2x 9'-0" 3x 7'-6"	1x 15'-0" 2x 11'-0" 3x 8'-6"	1x 20'-0" 2x 13'-0" 3x 11'-0"	1x 23'-0" 2x 16'-0" 3x 12'-6"	1x 25'-0" 2x 18'-0" 3x 14'-0"	1x 26'-0" 2x 18'-0" 3x 15'-0"	1x 28'-0" 2x 20'-0" 3x 16'-0"	1x 30'-0" 2x 20'-0" 3x 17'-0"
4.27 (14)	1x 15'-0" 2x 10'-0" 3x 8'-0"	1x 16'-0" 2x 11'-0" 3x 8'-6"	1x 21'-0" 2x 15'-0" 3x 12'-0"	1x 23'-0" 2x 16'-0" 3x 12'-6"	1x 28'-0" 2x 19'-0" 3x 15'-6"	1x 28'-0" 2x 20'-0" 3x 16'-0"	1x 31'-0" 2x 21'-0" 3x 17'-0"	1x 32'-0" 2x 22'-0" 3x 18'-0"
4.88 (16)	1x 15'-0" 2x 10'-0" 3x 8'-0"	1x 17'-0" 2x 11'-0" 3x 9'-0"	1x 21'-0" 2x 15'-0" 3x 12'-0"	1x 23'-0" 2x 16'-0" 3x 12'-6"	1x 28'-0" 2x 19'-0" 3x 15'-6"	1x 30'-0" 2x 21'-0" 3x 17'-0"	1x 34'-0" 2x 23'-0" 3x 19'-0"	1x 34'-0" 2x 24'-0" 3x 20'-0"
Vertical Reinforcement	ICF with 6" Tie Spacing	As per table A.2.1	As per table A.2.1	As per table A.2.1	As per table A.2.1	As per table A.2.1	As per table A.2.1	As per table A.2.1
ICF with 8" Tie Spacing	As per table A.2.2	As per table A.2.2	As per table A.2.2	As per table A.2.2	As per table A.2.2	As per table A.2.2	As per table A.2.2	As per table A.2.2
Horizontal Reinforcement	Block Height of 12" and 18"	As per table A.2.1	As per table A.2.1	As per table A.2.1	As per table A.2.1	As per table A.2.1	As per table A.2.1	As per table A.2.1
Block Height of 10"	As per table A.2.2	As per table A.2.2	As per table A.2.2	As per table A.2.2	As per table A.2.2	As per table A.2.2	As per table A.2.2	As per table A.2.2

**NOTES:**

1.  $S_{a,ICF}$  is equivalent spectral response acceleration for ICF walls as provided in Appendix A.
2. This table is to be used in conjunction with the "Design Limitations."
3. Provide two layers of the indicated horizontal and vertical distributed steel specified for 300mm (12") walls. Place each layer as shown in the rebar placement drawing.
4. All four sides of the building are to have a minimum number and length of shear walls that conforms to this table.
5. Provide 2-15M concentrated reinforcement at each end of shear walls as shown in shear wall detail.
6. All concentrated reinforcement is to be continues to the bottom of the foundation wall. Provide lap splices as required.
7. Concentrated reinforcement is to be placed in accordance with Bar Placement Detail.
8. Horizontal reinforcement in shear walls where  $S_{a,ICF} > 0.16$  must be anchored using a standard 180° hook around vertical end bars.
9. When using this table for  $S_{a,ICF} \leq 0.16$ , use the vertical and horizontal distributed steel in Tables A.2.1, or A.2.2.

**INSULATING CONCRETE FORMS MANUFACTURERS ASSOCIATION**

**Table A. 11.3200. – Above Grade Walkout Basement Shear Wall Length for Seismic Zone Classification,  $S_{a,ICF} \leq 0.31$  and Hourly Wind Pressure,  $q/50 \leq 1.05kPa$ , where Building Area  $\leq 3200ft^2$**

Wall Height m (ft)	Seismic Zone Classification							
	$S_{a,ICF} \leq 0.07$		$S_{a,ICF} \leq 0.11$		$S_{a,ICF} \leq 0.16$		$S_{a,ICF} \leq 0.31$	
Walkout Basement Wall of a Single Story ICF Structure Supporting Wood Framed Roof (TYPE W1)								
	6" & 8" Thick Wall	10" & 12" Thick Wall	6" & 8" Thick Wall	10" & 12" Thick Wall	6" & 8" Thick Wall	10" & 12" Thick Wall	6" & 8" Thick Wall	10" & 12" Thick Wall
	Number and length of shear walls provided							
2.44 (8)	1x 8'-0" 2x 5'-6" 3x 4'-6"	1x 8'-6" 2x 6'-0" 3x 4'-6"	1x 10'-0" 2x 7'-0" 3x 5'-0"	1x 10'-6" 2x 7'-6" 3x 6'-0"	1x 12'-0" 2x 8'-0" 3x 7'-0"	1x 13'-0" 2x 9'-0" 3x 7'-0"	1x 18'-0" 2x 12'-0" 3x 10'-0"	1x 19'-0" 2x 13'-0" 3x 10'-0"
2.75 (9)	1x 8'-0" 2x 5'-6" 3x 4'-6"	1x 9'-0" 2x 6'-0" 3x 5'-0"	1x 10'-6" 2x 7'-0" 3x 6'-0"	1x 11'-0" 2x 7'-6" 3x 6'-0"	1x 12'-6" 2x 9'-0" 3x 7'-0"	1x 13'-4" 2x 9'-4" 3x 7'-4"	1x 18'-0" 2x 12'-0" 3x 10'-0"	1x 19'-0" 2x 13'-0" 3x 10'-0"
3.05 (10)	1x 8'-6" 2x 6'-0" 3x 4'-6"	1x 9'-0" 2x 6'-0" 3x 5'-0"	1x 10'-6" 2x 7'-6" 3x 6'-0"	1x 11'-0" 2x 7'-6" 3x 6'-0"	1x 13'-0" 2x 9'-0" 3x 7'-6"	1x 13'-6" 2x 9'-6" 3x 7'-6"	1x 18'-6" 2x 13'-0" 3x 10'-6"	1x 19'-6" 2x 13'-6" 3x 11'-0"
3.66 (12)	1x 9'-0" 2x 6'-0" 3x 5'-0"	1x 10'-0" 2x 6'-0" 3x 5'-0"	1x 11'-4" 2x 8'-0" 3x 6'-0"	1x 12'-0" 2x 8'-0" 3x 6'-0"	1x 13'-6" 2x 9'-6" 3x 8'-0"	1x 14'-6" 2x 10'-0" 3x 8'-0"	1x 19'-6" 2x 13'-6" 3x 11'-0"	1x 21'-0" 2x 14'-0" 3x 11'-6"
Walkout Basement Walls of a Two Story Wood Framed Structure Supporting Wood Frame Floors and Roof (TYPE W2)								
	6" & 8" Thick Wall	10" & 12" Thick Wall	6" & 8" Thick Wall	10" & 12" Thick Wall	6" & 8" Thick Wall	10" & 12" Thick Wall	6" & 8" Thick Wall	10" & 12" Thick Wall
	Number and length of shear walls provided							
2.44 (8)	1x 9'-0" 2x 6'-6" 3x 5'-0"	1x 9'-6" 2x 6'-6" 3x 5'-0"	1x 10'-6" 2x 7'-6" 3x 6'-0"	1x 10'-6" 2x 7'-6" 3x 6'-0"	1x 13'-0" 2x 9'-0" 3x 7'-0"	1x 13'-0" 2x 9'-0" 3x 7'-0"	1x 18'-0" 2x 12'-6" 3x 10'-0"	1x 18'-0" 2x 12'-6" 3x 10'-0"
2.75 (9)	1x 9'-6" 2x 6'-6" 3x 5'-6"	1x 9'-6" 2x 6'-6" 3x 5'-6"	1x 11'-0" 2x 8'-0" 3x 6'-0"	1x 11'-0" 2x 8'-0" 3x 6'-0"	1x 13'-0" 2x 9'-4" 3x 7'-4"	1x 13'-0" 2x 9'-4" 3x 7'-4"	1x 18'-6" 2x 13'-0" 3x 10'-4"	1x 18'-6" 2x 13'-0" 3x 10'-4"
3.05 (10)	1x 10'-0" 2x 7'-0" 3x 5'-6"	1x 10'-0" 2x 7'-0" 3x 5'-6"	1x 11'-6" 2x 8'-0" 3x 6'-0"	1x 11'-6" 2x 8'-0" 3x 6'-0"	1x 13'-6" 2x 9'-4" 3x 7'-4"	1x 13'-6" 2x 9'-4" 3x 7'-4"	1x 19'-0" 2x 13'-4" 3x 10'-6"	1x 19'-0" 2x 13'-4" 3x 10'-6"
3.66 (12)	1x 10'-6" 2x 7'-0" 3x 5'-6"	1x 10'-6" 2x 7'-0" 3x 5'-6"	1x 12'-6" 2x 8'-0" 3x 6'-6"	1x 12'-6" 2x 8'-0" 3x 6'-6"	1x 14'-0" 2x 9'-6" 3x 7'-8"	1x 14'-0" 2x 9'-6" 3x 7'-8"	1x 19'-6" 2x 13'-6" 3x 11'-0"	1x 19'-6" 2x 13'-6" 3x 11'-0"
Walkout Basement Wall of a Two Story Building with Main Floor ICF Walls Supporting 2nd Story Wood Framed Walls, Floor and Roof (TYPE W3)								
	6" & 8" Thick Wall	10" & 12" Thick Wall	6" & 8" Thick Wall	10" & 12" Thick Wall	6" & 8" Thick Wall	10" & 12" Thick Wall	6" & 8" Thick Wall	10" & 12" Thick Wall
	Number and length of shear walls provided							
2.44 (8)	1x 10'-0" 2x 7'-0" 3x 5'-8"	1x 10'-0" 2x 7'-4" 3x 5'-8"	1x 12'-6" 2x 8'-6" 3x 7'-0"	1x 12'-6" 2x 8'-6" 3x 7'-0"	1x 15'-0" 2x 10'-6" 3x 8'-8"	1x 15'-6" 2x 10'-6" 3x 8'-8"	1x 21'-0" 2x 15'-0" 3x 12'-0"	1x 22'-0" 2x 15'-0" 3x 12'-0"
2.75 (9)	1x 10'-0" 2x 7'-4" 3x 5'-8"	1x 10'-0" 2x 7'-4" 3x 5'-8"	1x 12'-6" 2x 9'-0" 3x 7'-0"	1x 13'-0" 2x 9'-0" 3x 7'-0"	1x 16'-0" 2x 10'-6" 3x 8'-8"	1x 16'-0" 2x 11'-0" 3x 8'-8"	1x 21'-6" 2x 15'-0" 3x 12'-4"	1x 22'-0" 2x 15'-6" 3x 12'-4"
3.05 (10)	1x 10'-0" 2x 7'-4" 3x 5'-8"	1x 10'-6" 2x 7'-4" 3x 5'-8"	1x 13'-0" 2x 9'-0" 3x 7'-4"	1x 13'-0" 2x 9'-0" 3x 7'-4"	1x 16'-0" 2x 11'-0" 3x 8'-8"	1x 16'-0" 2x 11'-0" 3x 8'-8"	1x 22'-0" 2x 15'-0" 3x 12'-4"	1x 22'-6" 2x 15'-6" 3x 12'-6"
3.66 (12)	1x 11'-0" 2x 7'-4" 3x 6'-0"	1x 11'-0" 2x 7'-4" 3x 6'-0"	1x 13'-6" 2x 9'-6" 3x 7'-6"	1x 13'-6" 2x 9'-6" 3x 7'-6"	1x 16'-4" 2x 11'-4" 3x 9'-0"	1x 16'-6" 2x 11'-6" 3x 9'-4"	1x 23'-0" 2x 16'-0" 3x 13'-0"	1x 23'-6" 2x 16'-6" 3x 13'-0"
Walkout Basement Wall of Two Story ICF Structure Supporting Wood Frame Floors and Roof (TYPE W4)								
	6" & 8" Thick Wall	10" & 12" Thick Wall	6" & 8" Thick Wall	10" & 12" Thick Wall	6" & 8" Thick Wall	10" & 12" Thick Wall	6" & 8" Thick Wall	10" & 12" Thick Wall
	Number and length of shear walls provided							
2.44 (8)	1x 11'-0" 2x 7'-6" 3x 6'-4"	1x 12'-0" 2x 8'-0" 3x 6'-4"	1x 14'-0" 2x 10'-0" 3x 8'-0"	1x 14'-6" 2x 10'-0" 3x 8'-0"	1x 17'-0" 2x 12'-0" 3x 9'-6"	1x 18'-0" 2x 12'-6" 3x 10'-0"	1x 24'-0" 2x 17'-0" 3x 13'-6"	1x 25'-0" 2x 18'-0" 3x 14'-0"
2.75 (9)	1x 11'-6" 2x 8'-0" 3x 6'-4"	1x 12'-0" 2x 8'-0" 3x 6'-4"	1x 15'-0" 2x 10'-0" 3x 8'-0"	1x 15'-0" 2x 10'-6" 3x 8'-6"	1x 18'-0" 2x 12'-0" 3x 10'-0"	1x 18'-0" 2x 12'-6" 3x 10'-0"	1x 25'-0" 2x 17'-0" 3x 14'-0"	1x 26'-0" 2x 18'-0" 3x 14'-6"
3.05 (10)	1x 11'-6" 2x 8'-0" 3x 6'-4"	1x 12'-0" 2x 8'-4" 3x 6'-6"	1x 15'-0" 2x 10'-0" 3x 8'-6"	1x 15'-0" 2x 10'-6" 3x 8'-6"	1x 18'-0" 2x 12'-6" 3x 10'-6"	1x 18'-6" 2x 13'-0" 3x 10'-6"	1x 25'-0" 2x 18'-0" 3x 14'-0"	1x 26'-0" 2x 18'-0" 3x 15'-0"
3.66 (12)	1x 12'-0" 2x 8'-4" 3x 6'-8"	1x 12'-6" 2x 8'-6" 3x 7'-0"	1x 15'-6" 2x 10'-6" 3x 8'-6"	1x 16'-0" 2x 11'-0" 3x 9'-0"	1x 18'-6" 2x 13'-0" 3x 10'-6"	1x 19'-6" 2x 13'-6" 3x 11'-0"	1x 26'-0" 2x 18'-0" 3x 14'-6"	1x 27'-0" 2x 19'-0" 3x 15'-6"
Vertical Reinforcement	6", 8" and 10" thick wall	15 M @ 300 (12)	10 M @ 300 (12)	15 M @ 300 (12)	15 M @ 300 (12)	15 M @ 300 (12)	15 M @ 300 (12)	15 M @ 300 (12)
Horizontal Reinforcement	12" thick wall	10 M @ 300 (12)	10 M @ 300 (12)	10 M @ 300 (12)	10 M @ 300 (12)	10 M @ 300 (12)	10 M @ 300 (12)	10 M @ 300 (12)
Reinforcement	Block Height of 12" and 18"	10 M @ 450 (18)	10 M @ 450 (18)	10 M @ 450 (18)	10 M @ 450 (18)	10 M @ 450 (18)	10 M @ 450 (18)	10 M @ 450 (18)
Reinforcement	Block Height of 16"	10 M @ 400 (16)	10 M @ 400 (16)	10 M @ 400 (16)	10 M @ 400 (16)	10 M @ 400 (16)	10 M @ 400 (16)	10 M @ 400 (16)

**NOTES:**

1.  $S_{a,ICF}$  is equivalent spectral response acceleration for ICF walls as provided in Appendix A.
2. This table is to be used in conjunction with the "Design Limitations."
3. Provide two layers of the indicated horizontal and vertical distributed steel specified for 300mm (12") walls. Place each layer as shown in the rebar placement drawing.
4. All four sides of the building are to have a minimum number and length of shear walls that conforms to this table.
5. Provide 2-15M concentrated reinforcement at each end of shear walls as shown in shear wall detail.
6. All concentrated reinforcement is to be continues to the bottom of the foundation wall. Provide lap splices as required.
7. Concentrated reinforcement is to be placed in accordance with Bar Placement Detail.
8. Horizontal reinforcement in shear walls where  $S_{a,ICF} > 0.16$  must be anchored using a standard 180° hook around vertical end bars.
9. Walkout basement shear walls are to be reviewed and designed by a structural engineer where  $S_{a,ICF} > 0.31$ .

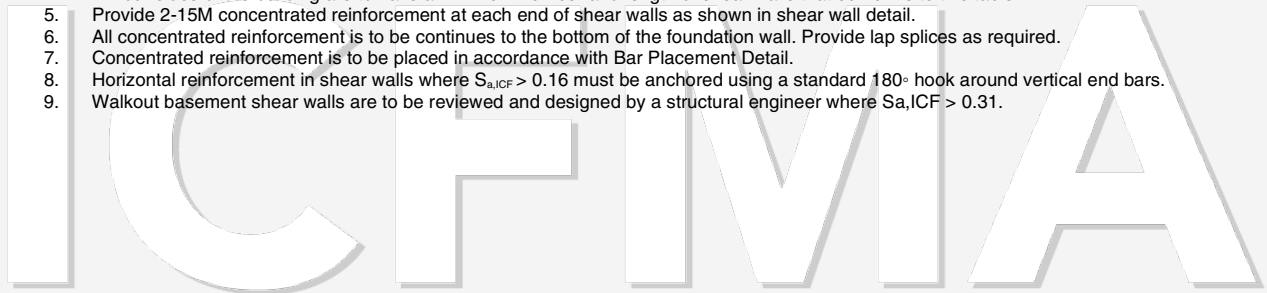

**INSULATING CONCRETE FORMS MANUFACTURERS ASSOCIATION**

**Table A.3.2400. Above Grade Shear Wall Length for Seismic Zone Classification,  $S_{a,ICF} \leq 0.16$  and Hourly Wind Pressure,  $q_{1/50} \leq 0.5kPa$  (in a Building Without Walkout Basement), where Building Area  $\leq 2400ft^2$**

Wall Height m (ft)	Seismic Zone Classification																		
	$S_{a,ICF} \leq 0.07$		$S_{a,ICF} \leq 0.11$		$S_{a,ICF} \leq 0.16$														
<b>Second Floor Walls of Two Story ICF Structure Supporting Wood Frame Roof (TYPE A)</b>																			
	6" & 8" Thick Wall		10" & 12" Thick Wall		6" & 8" Thick Wall		10" & 12" Thick Wall		6" & 8" Thick Wall		10" & 12" Thick Wall								
	Number and length of shear walls provided																		
2.44 (8)	1 x 7'-4"	2 x 3'-8"	3 x 2'-8"	1 x 7'-4"	2 x 3'-8"	3 x 2'-8"	1 x 7'-4"	2 x 3'-8"	3 x 2'-9"	1 x 7'-4"	2 x 3'-8"	3 x 2'-9"	1 x 7'-4"	2 x 3'-8"	3 x 2'-9"	1 x 7'-4"	2 x 3'-8"	3 x 2'-9"	
2.75 (9)	1 x 7'-4"	2 x 3'-8"	3 x 2'-8"	1 x 7'-4"	2 x 3'-8"	3 x 2'-8"	1 x 7'-4"	2 x 3'-8"	3 x 2'-9"	1 x 7'-4"	2 x 3'-8"	3 x 2'-9"	1 x 7'-4"	2 x 4'-2"	3 x 3'-3"	1 x 7'-4"	2 x 4'-7"	3 x 3'-3"	
3.05 (10)	1 x 7'-4"	2 x 3'-8"	3 x 2'-8"	1 x 7'-4"	2 x 3'-8"	3 x 2'-8"	1 x 7'-4"	2 x 3'-8"	3 x 2'-9"	1 x 7'-4"	2 x 3'-8"	3 x 2'-9"	1 x 7'-4"	2 x 4'-2"	3 x 3'-3"	1 x 7'-4"	2 x 5'-1"	3 x 3'-8"	
<b>Main Floor Walls of One Story ICF Structure Supporting Wood Frame Roof (TYPE B)</b>																			
	6" & 8" Thick Wall		10" & 12" Thick Wall		6" & 8" Thick Wall		10" & 12" Thick Wall		6" & 8" Thick Wall		10" & 12" Thick Wall								
	Number and length of shear walls provided																		
2.44 (8)	1 x 7'-4"	2 x 3'-8"	3 x 2'-8"	1 x 7'-4"	2 x 3'-8"	3 x 2'-8"	1 x 7'-4"	2 x 3'-8"	3 x 2'-9"	1 x 7'-4"	2 x 3'-8"	3 x 2'-9"	1 x 7'-4"	2 x 3'-8"	3 x 2'-9"	1 x 7'-4"	2 x 3'-8"	3 x 2'-9"	
2.75 (9)	1 x 7'-4"	2 x 3'-8"	3 x 2'-8"	1 x 7'-4"	2 x 3'-8"	3 x 2'-8"	1 x 7'-4"	2 x 3'-8"	3 x 2'-9"	1 x 7'-4"	2 x 3'-8"	3 x 2'-9"	1 x 7'-4"	2 x 4'-2"	3 x 3'-3"	1 x 7'-4"	2 x 4'-7"	3 x 3'-3"	
3.05 (10)	1 x 7'-4"	2 x 3'-8"	3 x 2'-8"	1 x 7'-4"	2 x 3'-8"	3 x 2'-8"	1 x 7'-4"	2 x 3'-8"	3 x 2'-9"	1 x 7'-4"	2 x 3'-8"	3 x 2'-9"	1 x 7'-4"	2 x 4'-2"	3 x 3'-3"	1 x 7'-4"	2 x 5'-1"	3 x 3'-8"	
3.66 (12)	1 x 7'-4"	2 x 3'-8"	3 x 2'-9"	1 x 7'-4"	2 x 3'-8"	3 x 2'-9"	1 x 7'-4"	2 x 4'-2"	3 x 3'-3"	1 x 7'-4"	2 x 4'-2"	3 x 3'-3"	1 x 8'-3"	2 x 5'-6"	3 x 4'-2"	1 x 8'-3"	2 x 5'-1"	3 x 4'-2"	
4.27 (14)	1 x 7'-4"	2 x 3'-8"	3 x 2'-9"	1 x 7'-4"	2 x 3'-8"	3 x 2'-9"	1 x 7'-4"	2 x 4'-7"	3 x 3'-8"	1 x 7'-4"	2 x 4'-7"	3 x 3'-8"	1 x 8'-7"	2 x 5'-6"	3 x 4'-7"	1 x 9'-2"	2 x 6'-5"	3 x 5'-1"	
4.88 (16)	1 x 7'-4"	2 x 3'-8"	3 x 2'-9"	1 x 7'-4"	2 x 4'-7"	3 x 3'-8"	1 x 7'-4"	2 x 4'-7"	3 x 3'-8"	1 x 8'-3"	2 x 5'-6"	3 x 4'-2"	1 x 9'-2"	2 x 5'-12"	3 x 4'-7"	1 x 10'-1"	2 x 6'-11"	3 x 5'-6"	
<b>Main Floor Walls of Two Story Structure Supporting 2nd Story Wood Framed Walls, Floor and Roof (TYPE C)</b>																			
	6" & 8" Thick Wall		10" & 12" Thick Wall		6" & 8" Thick Wall		10" & 12" Thick Wall		6" & 8" Thick Wall		10" & 12" Thick Wall								
	Number and length of shear walls provided																		
2.44 (8)	1 x 7'-4"	2 x 3'-8"	3 x 2'-9"	1 x 7'-4"	2 x 3'-8"	3 x 2'-9"	1 x 8'-3"	2 x 5'-6"	3 x 4'-7"	1 x 8'-3"	2 x 5'-12"	3 x 4'-7"	1 x 10'-1"	2 x 6'-5"	3 x 5'-1"	1 x 10'-7"	2 x 6'-5"	3 x 5'-1"	
2.75 (9)	1 x 7'-4"	2 x 4'-2"	3 x 3'-3"	1 x 7'-4"	2 x 4'-2"	3 x 3'-3"	1 x 8'-3"	2 x 5'-12"	3 x 4'-7"	1 x 9'-2"	2 x 6'-5"	3 x 4'-7"	1 x 11'-0"	2 x 6'-11"	3 x 5'-6"	1 x 11'-0"	2 x 6'-11"	3 x 5'-6"	
3.05 (10)	1 x 7'-4"	2 x 4'-7"	3 x 3'-8"	1 x 7'-4"	2 x 4'-7"	3 x 3'-8"	1 x 8'-9"	2 x 6'-9"	3 x 5'-6"	1 x 9'-2"	2 x 6'-9"	3 x 5'-6"	1 x 11'-0"	2 x 7'-4"	3 x 5'-12"	1 x 11'-6"	2 x 7'-4"	3 x 5'-12"	
3.66 (12)	1 x 7'-10"	2 x 5'-1"	3 x 3'-8"	1 x 7'-10"	2 x 5'-1"	3 x 3'-8"	1 x 9'-8"	2 x 7'-8"	3 x 5'-12"	1 x 9'-8"	2 x 7'-8"	3 x 5'-12"	1 x 11'-12"	2 x 8'-3"	3 x 6'-5"	1 x 11'-12"	2 x 8'-3"	3 x 6'-5"	
4.27 (14)	1 x 7'-10"	2 x 5'-1"	3 x 4'-2"	1 x 7'-10"	2 x 5'-6"	3 x 4'-2"	1 x 10'-1"	2 x 7'-10"	3 x 6'-5"	1 x 10'-7"	2 x 8'-3"	3 x 6'-5"	1 x 11'-12"	2 x 8'-3"	3 x 6'-5"	1 x 12'-11"	2 x 9'-2"	3 x 6'-11"	
4.88 (16)	1 x 7'-10"	2 x 5'-1"	3 x 4'-2"	1 x 8'-3"	2 x 5'-6"	3 x 4'-7"	1 x 10'-1"	2 x 8'-3"	3 x 6'-11"	1 x 11'-0"	2 x 8'-9"	3 x 6'-11"	1 x 11'-12"	2 x 8'-3"	3 x 6'-11"	1 x 13'-4"	2 x 9'-2"	3 x 6'-11"	
<b>Main Floor Walls of Two Story ICF Structure Supporting Wood Frame Floors and Roof (TYPE D)</b>																			
	6" & 8" Thick Wall		10" & 12" Thick Wall		6" & 8" Thick Wall		10" & 12" Thick Wall		6" & 8" Thick Wall		10" & 12" Thick Wall								
	Number and length of shear walls provided																		
2.44 (8)	1 x 8'-3"	2 x 5'-1"	3 x 3'-8"	1 x 8'-3"	2 x 5'-1"	3 x 4'-2"	1 x 10'-1"	2 x 6'-5"	3 x 5'-1"	1 x 11'-0"	2 x 7'-4"	3 x 5'-6"	1 x 12'-11"	2 x 8'-3"	3 x 6'-5"	1 x 14'-9"	2 x 9'-2"	3 x 7'-4"	
2.75 (9)	1 x 8'-3"	2 x 5'-6"	3 x 3'-8"	1 x 9'-2"	2 x 5'-6"	3 x 4'-7"	1 x 11'-0"	2 x 6'-11"	3 x 5'-6"	1 x 11'-12"	2 x 7'-4"	3 x 5'-6"	1 x 13'-10"	2 x 8'-9"	3 x 7'-4"	1 x 14'-9"	2 x 10'-1"	3 x 7'-4"	
3.05 (10)	1 x 8'-9"	2 x 5'-6"	3 x 4'-2"	1 x 9'-2"	2 x 5'-12"	3 x 4'-7"	1 x 11'-12"	2 x 7'-4"	3 x 5'-6"	1 x 11'-12"	2 x 7'-10"	3 x 6'-5"	1 x 14'-3"	2 x 9'-2"	3 x 7'-4"	1 x 15'-8"	2 x 10'-1"	3 x 7'-10"	
3.66 (12)	1 x 9'-2"	2 x 6'-5"	3 x 4'-7"	1 x 9'-2"	2 x 6'-5"	3 x 4'-7"	1 x 11'-12"	2 x 8'-3"	3 x 6'-5"	1 x 12'-5"	2 x 8'-3"	3 x 6'-5"	1 x 14'-9"	2 x 10'-1"	3 x 8'-3"	1 x 15'-8"	2 x 10'-1"	3 x 8'-3"	
4.27 (14)	1 x 9'-2"	2 x 6'-5"	3 x 5'-1"	1 x 10'-1"	2 x 6'-11"	3 x 5'-6"	1 x 11'-12"	2 x 8'-3"	3 x 6'-5"	1 x 13'-4"	2 x 8'-9"	3 x 7'-4"	1 x 14'-9"	2 x 10'-1"	3 x 8'-3"	1 x 16'-7"	2 x 11'-0"	3 x 9'-2"	
4.88 (16)	1 x 9'-2"	2 x 6'-5"	3 x 5'-1"	1 x 10'-7"	2 x 6'-11"	3 x 5'-6"	1 x 11'-12"	2 x 8'-3"	3 x 6'-5"	1 x 13'-6"	2 x 9'-2"	3 x 7'-4"	1 x 14'-9"	2 x 10'-1"	3 x 8'-3"	1 x 16'-7"	2 x 11'-6"	3 x 9'-2"	
Vertical Reinforcement	ICF with 6" Tie Spacing	As per table A.1.1.					As per table A.1.1.					As per table A.1.1.							
Vertical Reinforcement	ICF with 8" Tie Spacing	As per table A.1.2.					As per table A.1.2.					As per table A.1.2.							
Horizontal Reinforcement	Block Height of 12" and 18"	10 M @	450 (18)					10 M @	450 (18)					10 M @	450 (18)				
	Block Height of 16"	10 M @	400 (16)					10 M @	400 (16)					10 M @	400 (16)				

**NOTES:**

- $S_{a,ICF}$  is equivalent spectral response acceleration for ICF walls as provided in Appendix A.
- This table is to be used in conjunction with the "Design Limitations."
- Provide two layers of the indicated horizontal and vertical distributed steel specified for 300mm (12") walls. Place each layer as shown in the rebar placement drawing.
- All four sides of the building are to have a minimum number and length of shear walls that conforms to this table.
- Use Table A.6 for buildings that do not meet the required wall length of this table.
- Provide 2-15M concentrated reinforcement at each end of shear walls as shown in shear wall detail.
- All concentrated reinforcement is to be continues to the bottom of the foundation wall. Provide lap splices as required.
- Concentrated reinforcement is to be placed in accordance with Bar Placement Detail.

INSULATING CONCRETE FORMS  
MANUFACTURERS ASSOCIATION

**Table A.4.2400. Above Grade Shear Wall Length for Seismic Zone Classification,  $S_{a,ICF} \leq 0.16$  and Hourly Wind Pressure,  $0.5kPa < q1/50 \leq 0.75kPa$  (in a Building Without Walkout Basement), where Building Area  $\leq 2400ft^2$**

Wall Height m (ft)	Seismic Zone Classification					
	$S_{a,ICF} \leq 0.07$		$S_{a,ICF} \leq 0.11$		$S_{a,ICF} \leq 0.16$	
<b>Second Floor Walls of Two Story ICF Structure Supporting Wood Frame Roof (TYPE A)</b>						
	6" & 8" Thick Wall		10" & 12" Thick Wall		6" & 8" Thick Wall	
	Number and length of shear walls provided					
2.44 (8)	1 x 7'-4"	2 x 3'-8"	3 x 2'-8"	1 x 7'-4"	2 x 3'-8"	3 x 2'-8"
2.75 (9)	1 x 7'-4"	2 x 3'-8"	3 x 2'-8"	1 x 7'-4"	2 x 3'-8"	3 x 2'-9"
3.05 (10)	1 x 7'-4"	2 x 3'-8"	3 x 2'-8"	1 x 7'-4"	2 x 4'-2"	3 x 3'-3"
3.05 (10)	1 x 7'-4"	2 x 3'-8"	3 x 2'-8"	1 x 7'-4"	2 x 4'-2"	3 x 3'-3"
3.05 (10)	1 x 7'-4"	2 x 3'-8"	3 x 2'-8"	1 x 7'-4"	2 x 4'-2"	3 x 3'-3"
3.66 (12)	1 x 7'-4"	2 x 3'-8"	3 x 2'-9"	1 x 7'-4"	2 x 4'-2"	3 x 3'-3"
4.27 (14)	1 x 7'-4"	2 x 3'-8"	3 x 2'-9"	1 x 7'-4"	2 x 5'-1"	3 x 3'-8"
4.88 (16)	1 x 7'-4"	2 x 3'-8"	3 x 2'-9"	1 x 7'-4"	2 x 4'-7"	3 x 3'-8"
<b>Main Floor Walls of One Story ICF Structure Supporting Wood Frame Roof (TYPE B)</b>						
	6" & 8" Thick Wall		10" & 12" Thick Wall		6" & 8" Thick Wall	
	Number and length of shear walls provided					
2.44 (8)	1 x 7'-4"	2 x 3'-8"	3 x 2'-8"	1 x 7'-4"	2 x 3'-8"	3 x 2'-9"
2.75 (9)	1 x 7'-4"	2 x 3'-8"	3 x 2'-8"	1 x 7'-4"	2 x 3'-8"	3 x 2'-9"
3.05 (10)	1 x 7'-4"	2 x 3'-8"	3 x 2'-8"	1 x 7'-4"	2 x 3'-8"	3 x 2'-9"
3.05 (10)	1 x 7'-4"	2 x 3'-8"	3 x 2'-8"	1 x 7'-4"	2 x 4'-7"	3 x 3'-3"
3.66 (12)	1 x 7'-4"	2 x 3'-8"	3 x 2'-9"	1 x 7'-4"	2 x 4'-2"	3 x 3'-3"
4.27 (14)	1 x 7'-4"	2 x 3'-8"	3 x 2'-9"	1 x 7'-4"	2 x 4'-2"	3 x 3'-3"
4.88 (16)	1 x 7'-4"	2 x 3'-8"	3 x 2'-9"	1 x 7'-4"	2 x 4'-7"	3 x 3'-8"
<b>Main Floor Walls of Two Story Structure Supporting 2nd Story Wood Framed Walls, Floor and Roof (TYPE C)</b>						
	6" & 8" Thick Wall		10" & 12" Thick Wall		6" & 8" Thick Wall	
	Number and length of shear walls provided					
2.44 (8)	1 x 7'-4"	2 x 4'-2"	3 x 3'-3"	1 x 7'-4"	2 x 3'-8"	3 x 2'-9"
2.75 (9)	1 x 7'-4"	2 x 4'-2"	3 x 3'-3"	1 x 7'-4"	2 x 4'-2"	3 x 3'-3"
3.05 (10)	1 x 7'-4"	2 x 4'-2"	3 x 3'-3"	1 x 7'-4"	2 x 4'-2"	3 x 3'-3"
3.05 (10)	1 x 7'-4"	2 x 4'-2"	3 x 3'-3"	1 x 7'-4"	2 x 4'-2"	3 x 3'-3"
3.66 (12)	1 x 7'-4"	2 x 4'-2"	3 x 3'-3"	1 x 7'-4"	2 x 4'-2"	3 x 3'-3"
4.27 (14)	1 x 7'-4"	2 x 4'-2"	3 x 3'-3"	1 x 7'-4"	2 x 4'-2"	3 x 3'-3"
4.88 (16)	1 x 7'-4"	2 x 4'-2"	3 x 3'-3"	1 x 7'-4"	2 x 4'-2"	3 x 3'-3"
<b>Main Floor Walls of Two Story ICF Structure Supporting Wood Frame Floors and Roof (TYPE D)</b>						
	6" & 8" Thick Wall		10" & 12" Thick Wall		6" & 8" Thick Wall	
	Number and length of shear walls provided					
2.44 (8)	1 x 8'-3"	2 x 5'-1"	3 x 4'-2"	1 x 8'-3"	2 x 5'-1"	3 x 4'-2"
2.75 (9)	1 x 8'-3"	2 x 5'-1"	3 x 4'-2"	1 x 8'-3"	2 x 5'-1"	3 x 4'-2"
3.05 (10)	1 x 8'-3"	2 x 5'-1"	3 x 4'-2"	1 x 8'-3"	2 x 5'-1"	3 x 4'-2"
3.05 (10)	1 x 8'-3"	2 x 5'-1"	3 x 4'-2"	1 x 8'-3"	2 x 5'-1"	3 x 4'-2"
3.66 (12)	1 x 9'-2"	2 x 6'-5"	3 x 4'-7"	1 x 9'-2"	2 x 6'-5"	3 x 4'-7"
4.27 (14)	1 x 9'-2"	2 x 6'-5"	3 x 4'-7"	1 x 9'-2"	2 x 6'-5"	3 x 4'-7"
4.88 (16)	1 x 9'-2"	2 x 6'-5"	3 x 4'-7"	1 x 9'-2"	2 x 6'-5"	3 x 4'-7"
Vertical Reinforcement	ICF with 6" Tie Spacing	As per table A.1.1.		As per table A.1.1.		As per table A.1.1.
Vertical Reinforcement	ICF with 8" Tie Spacing	As per table A.1.2.		As per table A.1.2.		As per table A.1.2.
Horizontal Reinforcement	Block Height of 12" and 18"	10 M @	450 (18)	10 M @	450 (18)	10 M @ 450 (18)
Horizontal Reinforcement	Block Height of 16"	10 M @	400 (16)	10 M @	400 (16)	10 M @ 400 (16)

**NOTES:**

1.  $S_{a,ICF}$  is equivalent spectral response acceleration for ICF walls as provided in Appendix A.
2. This table is to be used in conjunction with the "Design Limitations."
3. Provide two layers of the indicated horizontal and vertical distributed steel specified for 300mm (12") walls. Place each layer as shown in the rebar placement drawing.
4. All four sides of the building are to have a minimum number and length of shear walls that conforms to this table.
5. Use Table A.6 for buildings that do not meet the required wall length of this table.
6. Provide 2-15M concentrated reinforcement at each end of shear walls as shown in shear wall detail.
7. All concentrated reinforcement is to be continues to the bottom of the foundation wall. Provide lap splices as required.
8. Concentrated reinforcement is to be placed in accordance with Bar Placement Detail.

INSULATING CONCRETE FORMS MANUFACTURERS ASSOCIATION

**Table A.5.2400. Above Grade Shear Wall Length for Seismic Zone Classification,  $S_{a,ICF} \leq 0.16$  and Hourly Wind Pressure,  $0.5kPa < q_{1/50} \leq 0.75kPa$  (in a Building Without Walkout Basement), where Building Area  $\leq 2400ft^2$**

Wall Height m (ft)	Seismic Zone Classification											
	$S_{a,ICF} \leq 0.07$		$S_{a,ICF} \leq 0.11$		$S_{a,ICF} \leq 0.16$							
<b>Second Floor Walls of Two Story ICF Structure Supporting Wood Frame Roof (TYPE A)</b>												
	6" & 8" Thick Wall		10" & 12" Thick Wall		6" & 8" Thick Wall		10" & 12" Thick Wall					
	Number and length of shear walls provided											
2.44 (8)	1 x 7'-4"	2 x 3'-8"	3 x 2'-8"	1 x 7'-4"	2 x 3'-8"	3 x 2'-8"	1 x 7'-4"	2 x 3'-8"	3 x 2'-9"	1 x 7'-4"	2 x 3'-8"	3 x 2'-9"
2.75 (9)	1 x 7'-4"	2 x 3'-8"	3 x 2'-8"	1 x 7'-4"	2 x 3'-8"	3 x 2'-8"	1 x 7'-4"	2 x 3'-8"	3 x 2'-9"	1 x 7'-4"	2 x 3'-8"	3 x 3'-3"
3.05 (10)	1 x 7'-4"	2 x 3'-8"	3 x 2'-8"	1 x 7'-4"	2 x 3'-8"	3 x 2'-8"	1 x 7'-4"	2 x 4'-2"	3 x 3'-3"	1 x 7'-4"	2 x 4'-2"	3 x 3'-3"
3.66 (12)	1 x 7'-4"	2 x 3'-8"	3 x 2'-9"	1 x 7'-4"	2 x 3'-8"	3 x 2'-9"	1 x 7'-4"	2 x 4'-2"	3 x 3'-3"	1 x 8'-3"	2 x 5'-6"	3 x 4'-2"
4.27 (14)	1 x 7'-4"	2 x 3'-8"	3 x 2'-9"	1 x 7'-4"	2 x 3'-8"	3 x 2'-9"	1 x 7'-4"	2 x 4'-7"	3 x 3'-8"	1 x 8'-7"	2 x 5'-6"	3 x 4'-7"
4.88 (16)	1 x 7'-4"	2 x 3'-8"	3 x 2'-9"	1 x 7'-4"	2 x 4'-7"	3 x 3'-8"	1 x 7'-4"	2 x 4'-7"	3 x 3'-8"	1 x 8'-3"	2 x 5'-6"	3 x 4'-2"
<b>Main Floor Walls of One Story ICF Structure Supporting Wood Frame Roof (TYPE B)</b>												
	6" & 8" Thick Wall		10" & 12" Thick Wall		6" & 8" Thick Wall		10" & 12" Thick Wall					
	Number and length of shear walls provided											
2.44 (8)	1 x 7'-4"	2 x 3'-8"	3 x 2'-8"	1 x 7'-4"	2 x 3'-8"	3 x 2'-8"	1 x 7'-4"	2 x 3'-8"	3 x 2'-9"	1 x 7'-4"	2 x 3'-8"	3 x 2'-9"
2.75 (9)	1 x 7'-4"	2 x 3'-8"	3 x 2'-8"	1 x 7'-4"	2 x 3'-8"	3 x 2'-8"	1 x 7'-4"	2 x 3'-8"	3 x 2'-9"	1 x 7'-4"	2 x 3'-8"	3 x 2'-9"
3.05 (10)	1 x 7'-4"	2 x 3'-8"	3 x 2'-8"	1 x 7'-4"	2 x 3'-8"	3 x 2'-8"	1 x 7'-4"	2 x 3'-8"	3 x 2'-9"	1 x 7'-4"	2 x 4'-7"	3 x 3'-3"
3.66 (12)	1 x 7'-4"	2 x 3'-8"	3 x 2'-9"	1 x 7'-4"	2 x 3'-8"	3 x 2'-9"	1 x 7'-4"	2 x 4'-2"	3 x 3'-3"	1 x 7'-4"	2 x 4'-2"	3 x 3'-3"
4.27 (14)	1 x 7'-4"	2 x 3'-8"	3 x 2'-9"	1 x 7'-4"	2 x 3'-8"	3 x 2'-9"	1 x 7'-4"	2 x 4'-7"	3 x 3'-8"	1 x 7'-4"	2 x 5'-1"	3 x 3'-8"
4.88 (16)	1 x 7'-4"	2 x 3'-8"	3 x 2'-9"	1 x 7'-4"	2 x 4'-7"	3 x 3'-8"	1 x 7'-4"	2 x 4'-7"	3 x 3'-8"	1 x 8'-3"	2 x 5'-6"	3 x 4'-2"
<b>Main Floor Walls of Two Story Structure Supporting 2nd Story Wood Framed Walls, Floor and Roof (TYPE C)</b>												
	6" & 8" Thick Wall		10" & 12" Thick Wall		6" & 8" Thick Wall		10" & 12" Thick Wall					
	Number and length of shear walls provided											
2.44 (8)	1 x 7'-4"	2 x 4'-4"	3 x 3'-3"	1 x 7'-4"	2 x 3'-8"	3 x 2'-9"	1 x 8'-3"	2 x 5'-6"	3 x 4'-7"	1 x 8'-3"	2 x 5'-12"	3 x 4'-7"
2.75 (9)	1 x 7'-4"	2 x 4'-4"	3 x 3'-3"	1 x 7'-4"	2 x 4'-7"	3 x 3'-8"	1 x 8'-3"	2 x 5'-12"	3 x 4'-7"	1 x 9'-2"	2 x 6'-5"	3 x 4'-7"
3.05 (10)	1 x 7'-4"	2 x 4'-8"	3 x 3'-8"	1 x 7'-4"	2 x 4'-7"	3 x 3'-8"	1 x 9'-2"	2 x 6'-9"	3 x 5'-6"	1 x 9'-2"	2 x 6'-9"	3 x 5'-6"
3.66 (12)	1 x 7'-10"	2 x 5'-1"	3 x 3'-8"	1 x 7'-10"	2 x 5'-1"	3 x 3'-9"	1 x 9'-8"	2 x 7'-8"	3 x 5'-12"	1 x 9'-8"	2 x 7'-8"	3 x 5'-12"
4.27 (14)	1 x 7'-10"	2 x 5'-1"	3 x 4'-2"	1 x 7'-10"	2 x 5'-6"	3 x 4'-2"	1 x 10'-1"	2 x 7'-10"	3 x 6'-5"	1 x 10'-7"	2 x 8'-3"	3 x 6'-5"
4.88 (16)	1 x 7'-10"	2 x 5'-1"	3 x 4'-2"	1 x 7'-4"	2 x 5'-6"	3 x 4'-7"	1 x 10'-1"	2 x 8'-3"	3 x 6'-11"	1 x 11'-0"	2 x 8'-9"	3 x 6'-11"
<b>Main Floor Walls of Two Story ICF Structure Supporting Wood Frame Floors and Roof (TYPE D)</b>												
	6" & 8" Thick Wall		10" & 12" Thick Wall		6" & 8" Thick Wall		10" & 12" Thick Wall					
	Number and length of shear walls provided											
2.44 (8)	1 x 8'-3"	2 x 5'-1"	3 x 4'-2"	1 x 8'-3"	2 x 5'-1"	3 x 4'-2"	1 x 10'-1"	2 x 6'-11"	3 x 5'-6"	1 x 11'-0"	2 x 7'-4"	3 x 5'-6"
2.75 (9)	1 x 8'-3"	2 x 5'-6"	3 x 4'-2"	1 x 9'-2"	2 x 5'-12"	3 x 4'-7"	1 x 11'-0"	2 x 6'-11"	3 x 5'-6"	1 x 11'-12"	2 x 7'-10"	3 x 5'-12"
3.05 (10)	1 x 8'-9"	2 x 5'-12"	3 x 3'-3"	1 x 9'-2"	2 x 5'-12"	3 x 4'-7"	1 x 11'-12"	2 x 7'-10"	3 x 5'-12"	1 x 11'-12"	2 x 7'-10"	3 x 6'-5"
3.66 (12)	1 x 9'-2"	2 x 6'-5"	3 x 4'-7"	1 x 9'-8"	2 x 6'-5"	3 x 5'-1"	1 x 11'-12"	2 x 8'-3"	3 x 6'-5"	1 x 12'-5"	2 x 8'-3"	3 x 6'-5"
4.27 (14)	1 x 9'-2"	2 x 6'-5"	3 x 5'-1"	1 x 10'-1"	2 x 6'-11"	3 x 5'-6"	1 x 11'-12"	2 x 8'-3"	3 x 6'-5"	1 x 13'-4"	2 x 8'-9"	3 x 7'-4"
4.88 (16)	1 x 9'-2"	2 x 6'-5"	3 x 5'-1"	1 x 10'-7"	2 x 6'-11"	3 x 5'-6"	1 x 11'-12"	2 x 8'-3"	3 x 6'-5"	1 x 13'-4"	2 x 9'-2"	3 x 7'-4"
Vertical Reinforcement	ICF with 6" Tie Spacing	As per table A.1.1.				As per table A.1.1.		As per table A.1.1.				
Vertical Reinforcement	ICF with 8" Tie Spacing	As per table A.1.2.				As per table A.1.2.		As per table A.1.2.				
Horizontal Reinforcement	Block Height of 12" and 18"	10 M @ 450 (18)		10 M @ 450 (18)		10 M @ 450 (18)		10 M @ 450 (18)				
Horizontal Reinforcement	Block Height of 16"	10 M @ 400 (16)		10 M @ 400 (16)		10 M @ 400 (16)		10 M @ 400 (16)				

**NOTES:**

1.  $S_{a,ICF}$  is equivalent spectral response acceleration for ICF walls as provided in Appendix A.
2. This table is to be used in conjunction with the "Design Limitations."
3. Provide two layers of the indicated horizontal and vertical distributed steel specified for 300mm (12") walls. Place each layer as shown in the rebar placement drawing.
4. All four sides of the building are to have a minimum number and length of shear walls that conforms to this table.
5. Use Table A.6 for buildings that do not meet the required wall length of this table.
6. Provide 2-15M concentrated reinforcement at each end of shear walls as shown in shear wall detail.
7. All concentrated reinforcement is to be continues to the bottom of the foundation wall. Provide lap splices as required.
8. Concentrated reinforcement is to be placed in accordance with Bar Placement Detail.

INSULATING CONCRETE FORMS MANUFACTURERS ASSOCIATION



**Table A.6.2400. Above Grade Shear Wall Length for Seismic Zone Classification,  $S_{a,ICF} > 0.16$  and Hourly Wind Pressure,  $q_{1/50} \leq 1.05\text{kPa}$  (in a Building Without Walkout Basement), where Building Area  $\leq 2400\text{ft}^2$**

Wall Height m (ft)	Seismic Zone Classification								
	$S_{a,ICF} \leq 0.16$		$S_{a,ICF} \leq 0.31$		$S_{a,ICF} \leq 0.53$		$S_{a,ICF} \leq 0.79$		
<b>Second Floor Walls of Two Story ICF Structure Supporting Wood Frame Roof (TYPE A)</b>									
	6" & 8" Thick Wall		10" & 12" Thick Wall		6" & 8" Thick Wall		10" & 12" Thick Wall		
	Number and length of shear walls provided								
2.44 (8)	1x7'-4"	2x3'-8"	3x2'-9"	1x7'-4"	2x3'-8"	3x2'-9"	1x7'-4"	2x3'-8"	3x2'-9"
2.75 (9)	1x7'-4"	2x3'-8"	3x2'-9"	1x7'-4"	2x3'-8"	3x2'-9"	1x7'-4"	2x3'-8"	3x2'-9"
3.05 (10)	1x7'-4"	2x3'-8"	3x2'-9"	1x7'-4"	2x3'-8"	3x2'-9"	1x7'-4"	2x3'-8"	3x2'-9"
3.66 (12)	1x7'-4"	2x3'-8"	3x2'-9"	1x7'-4"	2x3'-8"	3x2'-9"	1x7'-4"	2x3'-8"	3x2'-9"
4.27 (14)	1x7'-4"	2x3'-8"	3x2'-9"	1x7'-4"	2x3'-8"	3x2'-9"	1x7'-4"	2x3'-8"	3x2'-9"
4.88 (16)	1x7'-4"	2x3'-8"	3x2'-9"	1x7'-4"	2x3'-8"	3x2'-9"	1x7'-4"	2x3'-8"	3x2'-9"
<b>Main Floor Walls of One Story ICF Structure Supporting Wood Frame Roof (TYPE B)</b>									
	6" & 8" Thick Wall		10" & 12" Thick Wall		6" & 8" Thick Wall		10" & 12" Thick Wall		
	Number and length of shear walls provided								
2.44 (8)	1x7'-4"	2x3'-8"	3x2'-9"	1x7'-4"	2x3'-8"	3x2'-9"	1x7'-4"	2x3'-8"	3x2'-9"
2.75 (9)	1x7'-4"	2x3'-8"	3x2'-9"	1x7'-4"	2x3'-8"	3x2'-9"	1x7'-4"	2x3'-8"	3x2'-9"
3.05 (10)	1x7'-4"	2x3'-8"	3x2'-9"	1x7'-4"	2x3'-8"	3x2'-9"	1x7'-4"	2x3'-8"	3x2'-9"
3.66 (12)	1x7'-4"	2x3'-8"	3x2'-9"	1x7'-4"	2x3'-8"	3x2'-9"	1x7'-4"	2x3'-8"	3x2'-9"
4.27 (14)	1x7'-4"	2x3'-8"	3x2'-9"	1x7'-4"	2x3'-8"	3x2'-9"	1x7'-4"	2x3'-8"	3x2'-9"
4.88 (16)	1x7'-4"	2x3'-8"	3x2'-9"	1x7'-4"	2x3'-8"	3x2'-9"	1x7'-4"	2x3'-8"	3x2'-9"
<b>Main Floor Walls of Two Story Structure Supporting 2nd Story Wood Framed Walls, Floor and Roof (TYPE C)</b>									
	6" & 8" Thick Wall		10" & 12" Thick Wall		6" & 8" Thick Wall		10" & 12" Thick Wall		
	Number and length of shear walls provided								
2.44 (8)	1x8'-3"	2x5'-6"	3x4'-7"	1x8'-3"	2x5'-6"	3x4'-7"	1x8'-3"	2x5'-6"	3x4'-7"
2.75 (9)	1x8'-3"	2x5'-6"	3x4'-7"	1x8'-3"	2x5'-6"	3x4'-7"	1x8'-3"	2x5'-6"	3x4'-7"
3.05 (10)	1x8'-3"	2x5'-6"	3x4'-7"	1x8'-3"	2x5'-6"	3x4'-7"	1x8'-3"	2x5'-6"	3x4'-7"
3.66 (12)	1x8'-3"	2x5'-6"	3x4'-7"	1x8'-3"	2x5'-6"	3x4'-7"	1x8'-3"	2x5'-6"	3x4'-7"
4.27 (14)	1x8'-3"	2x5'-6"	3x4'-7"	1x8'-3"	2x5'-6"	3x4'-7"	1x8'-3"	2x5'-6"	3x4'-7"
4.88 (16)	1x8'-3"	2x5'-6"	3x4'-7"	1x8'-3"	2x5'-6"	3x4'-7"	1x8'-3"	2x5'-6"	3x4'-7"
<b>Main Floor Walls of Two Story ICF Structure Supporting Wood Frame Floors and Roof (TYPE D)</b>									
	6" & 8" Thick Wall		10" & 12" Thick Wall		6" & 8" Thick Wall		10" & 12" Thick Wall		
	Number and length of shear walls provided								
2.44 (8)	1x10'-1"	2x6'-11"	3x5'-6"	1x10'-1"	2x6'-11"	3x5'-6"	1x10'-1"	2x6'-11"	3x5'-6"
2.75 (9)	1x10'-1"	2x6'-11"	3x5'-6"	1x10'-1"	2x6'-11"	3x5'-6"	1x10'-1"	2x6'-11"	3x5'-6"
3.05 (10)	1x10'-1"	2x6'-11"	3x5'-6"	1x10'-1"	2x6'-11"	3x5'-6"	1x10'-1"	2x6'-11"	3x5'-6"
3.66 (12)	1x10'-1"	2x6'-11"	3x5'-6"	1x10'-1"	2x6'-11"	3x5'-6"	1x10'-1"	2x6'-11"	3x5'-6"
4.27 (14)	1x10'-1"	2x6'-11"	3x5'-6"	1x10'-1"	2x6'-11"	3x5'-6"	1x10'-1"	2x6'-11"	3x5'-6"
4.88 (16)	1x10'-1"	2x6'-11"	3x5'-6"	1x10'-1"	2x6'-11"	3x5'-6"	1x10'-1"	2x6'-11"	3x5'-6"
Vertical Reinforcement	ICF with 6" The Spec'ing	As per table A.2.1.		As per table A.2.1.		As per table A.2.1.		As per table A.2.1.	
Horizontal Reinforcement	ICF with 8" The Spec'ing	As per table A.2.2.		As per table A.2.2.		As per table A.2.2.		As per table A.2.2.	
Horizontal Reinforcement	Block Height of 12" and 18"	As per table A.2.1.		As per table A.2.1.		As per table A.2.1.		As per table A.2.1.	
Horizontal Reinforcement	Block Height of 16"	As per table A.2.2.		As per table A.2.2.		As per table A.2.2.		As per table A.2.2.	

**NOTES:**

1.  $S_{a,ICF}$  is equivalent spectral response acceleration for ICF walls as provided in Appendix A.
2. This table is to be used in conjunction with the "Design Limitations."
3. Provide two layers of the indicated horizontal and vertical distributed steel specified for 300mm (12") walls. Place each layer as shown in the rebar placement drawing.
4. All four sides of the building are to have a minimum number and length of shear walls that conforms to this table.
5. Provide 2-15M concentrated reinforcement at each end of shear walls as shown in shear wall detail.
6. All concentrated reinforcement is to be continues to the bottom of the foundation wall. Provide lap splices as required.
7. Concentrated reinforcement is to be placed in accordance with Bar Placement Detail.
8. Horizontal reinforcement in shear walls where  $S_{a,ICF} > 0.16$  must be anchored using a standard 180° hook around vertical end bars.
9. When using this table for  $S_{a,ICF} \leq 0.16$ , use the vertical and horizontal distributed steel in Tables A.2.1. or A.2.2.

INSULATING CONCRETE FORMS MANUFACTURERS ASSOCIATION

**Table A.7.2400. Above Grade Shear Wall Length for Seismic Zone Classification,  $S_{a,ICF} \leq 0.16$  and Hourly Wind Pressure,  $q_{1/50} \leq 0.5kPa$  (in a Building With Walk Basement), where Building Area  $\leq 2400ft^2$**

Wall Height m (ft)	Seismic Zone Classification					
	$S_{a,ICF} \leq 0.07$		$S_{a,ICF} \leq 0.11$		$S_{a,ICF} \leq 0.16$	
<b>Second Floor Walls of Two Story ICF Structure Supporting Wood Frame Roof (TYPE E)</b>						
	6" & 8" Thick Wall		10" & 12" Thick Wall		6" & 8" Thick Wall	
	Number and length of shear walls provided					
2.44 (8)	1 x 7'-4"	2 x 3'-8"	3 x 2'-8"	1 x 7'-4"	2 x 3'-8"	3 x 2'-9"
2.75 (9)	1 x 7'-4"	2 x 3'-8"	3 x 2'-8"	1 x 7'-4"	2 x 3'-8"	3 x 2'-9"
3.05 (10)	1 x 7'-4"	2 x 3'-8"	3 x 2'-8"	1 x 7'-4"	2 x 4'-2"	3 x 3'-3"
3.66 (12)	1 x 7'-4"	2 x 3'-8"	3 x 2'-8"	1 x 7'-4"	2 x 4'-2"	3 x 3'-3"
4.27 (14)	1 x 7'-4"	2 x 4'-2"	3 x 3'-8"	1 x 7'-4"	2 x 4'-7"	3 x 3'-3"
4.88 (16)	1 x 7'-4"	2 x 4'-7"	3 x 3'-8"	1 x 7'-4"	2 x 4'-7"	3 x 3'-3"
<b>Main Floor Walls of One Story ICF Structure Supporting Wood Frame Roof (TYPE F)</b>						
	6" & 8" Thick Wall		10" & 12" Thick Wall		6" & 8" Thick Wall	
	Number and length of shear walls provided					
2.44 (8)	1 x 7'-4"	2 x 3'-8"	3 x 2'-8"	1 x 7'-4"	2 x 3'-8"	3 x 2'-9"
2.75 (9)	1 x 7'-4"	2 x 3'-8"	3 x 2'-8"	1 x 7'-4"	2 x 3'-8"	3 x 2'-9"
3.05 (10)	1 x 7'-4"	2 x 3'-8"	3 x 2'-8"	1 x 7'-4"	2 x 4'-2"	3 x 3'-3"
3.66 (12)	1 x 7'-4"	2 x 3'-8"	3 x 2'-8"	1 x 7'-4"	2 x 4'-2"	3 x 3'-3"
4.27 (14)	1 x 7'-4"	2 x 4'-2"	3 x 3'-8"	1 x 7'-4"	2 x 4'-7"	3 x 3'-8"
4.88 (16)	1 x 7'-4"	2 x 4'-7"	3 x 3'-8"	1 x 7'-4"	2 x 4'-7"	3 x 3'-8"
<b>Main Floor Walls of Two Story Structure Supporting 2nd Story Wood Framed Walls, Floor and Roof (TYPE G)</b>						
	6" & 8" Thick Wall		10" & 12" Thick Wall		6" & 8" Thick Wall	
	Number and length of shear walls provided					
2.44 (8)	1 x 7'-4"	2 x 4'-7"	3 x 3'-8"	1 x 9'-2"	2 x 5'-6"	3 x 4'-7"
2.75 (9)	1 x 7'-4"	2 x 4'-7"	3 x 3'-8"	1 x 9'-2"	2 x 5'-6"	3 x 4'-7"
3.05 (10)	1 x 7'-4"	2 x 4'-7"	3 x 3'-8"	1 x 9'-2"	2 x 5'-6"	3 x 4'-7"
3.66 (12)	1 x 7'-4"	2 x 4'-7"	3 x 3'-8"	1 x 9'-2"	2 x 5'-6"	3 x 4'-7"
4.27 (14)	1 x 7'-4"	2 x 4'-7"	3 x 3'-8"	1 x 9'-2"	2 x 5'-6"	3 x 4'-7"
4.88 (16)	1 x 7'-4"	2 x 4'-7"	3 x 3'-8"	1 x 9'-2"	2 x 5'-6"	3 x 4'-7"
<b>Main Floor Walls of Two Story ICF Structure Supporting Wood Frame Floors and Roof (TYPE H)</b>						
	6" & 8" Thick Wall		10" & 12" Thick Wall		6" & 8" Thick Wall	
	Number and length of shear walls provided					
2.44 (8)	1 x 8'-7"	2 x 5'-6"	3 x 4'-2"	1 x 9'-2"	2 x 5'-6"	3 x 4'-7"
2.75 (9)	1 x 8'-7"	2 x 5'-6"	3 x 4'-2"	1 x 9'-2"	2 x 5'-6"	3 x 4'-7"
3.05 (10)	1 x 8'-7"	2 x 5'-6"	3 x 4'-2"	1 x 9'-2"	2 x 5'-6"	3 x 4'-7"
3.66 (12)	1 x 8'-7"	2 x 5'-6"	3 x 4'-2"	1 x 9'-2"	2 x 5'-6"	3 x 4'-7"
4.27 (14)	1 x 8'-7"	2 x 5'-6"	3 x 4'-2"	1 x 9'-2"	2 x 5'-6"	3 x 4'-7"
4.88 (16)	1 x 8'-7"	2 x 5'-6"	3 x 4'-2"	1 x 9'-2"	2 x 5'-6"	3 x 4'-7"
Vertical Reinforcement	ICF with 6" Tie Spacing	As per table A.1.1.		As per table A.1.1.		As per table A.1.1.
Vertical Reinforcement	ICF with 8" Tie Spacing	As per table A.1.2.		As per table A.1.2.		As per table A.1.2.
Horizontal Reinforcement	Block Height of 12" and 18"	10 M @ 450 (18)		10 M @ 450 (18)		10 M @ 450 (18)
Horizontal Reinforcement	Block Height of 16"	10 M @ 400 (16)		10 M @ 400 (16)		10 M @ 400 (16)

**NOTES:**

1.  $S_{a,ICF}$  is equivalent spectral response acceleration for ICF walls as provided in Appendix A.
2. This table is to be used in conjunction with the "Design Limitations."
3. Provide two layers of the indicated horizontal and vertical distributed steel specified for 300mm (12") walls. Place each layer as shown in the rebar placement drawing.
4. All four sides of the building are to have a minimum number and length of shear walls that conforms to this table.
5. Use Table A.6 for buildings that do not meet the required wall length of this table.
6. Provide 2-15M concentrated reinforcement at each end of shear walls as shown in shear wall detail.
7. All concentrated reinforcement is to be continues to the bottom of the foundation wall. Provide lap splices as required.
8. Concentrated reinforcement is to be placed in accordance with Bar Placement Detail.

INSULATING CONCRETE FORMS MANUFACTURERS ASSOCIATION



**Table A.9.2400. Above Grade Shear Wall Length for Seismic Zone Classification,  $S_{a,ICF} \leq 0.16$  and Hourly Wind Pressure,  $0.75kPa < q_{1/50} \leq 1.05kPa$  (in a Building With Walkout Basement), where Building Area  $\leq 2400ft^2$**

Wall Height m (ft)	Seismic Zone Classification					
	$S_{a,ICF} \leq 0.07$		$S_{a,ICF} \leq 0.11$		$S_{a,ICF} \leq 0.16$	
<b>Second Floor Walls of Two Story ICF Structure Supporting Wood Frame Roof (TYPE E)</b>						
	6" & 8" Thick Wall		10" & 12" Thick Wall		6" & 8" Thick Wall	
	Number and length of shear walls provided					
2.44 (8)	1 x 7'-4"	2 x 3'-8"	3 x 2'-8"	1 x 7'-4"	2 x 3'-8"	3 x 2'-8"
2.75 (9)	1 x 7'-4"	2 x 3'-8"	3 x 2'-8"	1 x 7'-4"	2 x 3'-8"	3 x 2'-9"
3.05 (10)	1 x 7'-4"	2 x 3'-8"	3 x 2'-8"	1 x 7'-4"	2 x 3'-12"	3 x 3'-11"
3.66 (12)	1 x 7'-4"	2 x 3'-8"	3 x 2'-9"	1 x 7'-4"	2 x 4'-7"	3 x 3'-8"
4.27 (14)	1 x 7'-4"	2 x 3'-8"	3 x 2'-9"	1 x 7'-4"	2 x 4'-7"	3 x 3'-4"
4.88 (16)	1 x 7'-4"	2 x 3'-8"	3 x 2'-9"	1 x 7'-4"	2 x 4'-7"	3 x 3'-4"
<b>Main Floor Walls of One Story ICF Structure Supporting Wood Frame Roof (TYPE F)</b>						
	6" & 8" Thick Wall		10" & 12" Thick Wall		6" & 8" Thick Wall	
	Number and length of shear walls provided					
2.44 (8)	1 x 7'-4"	2 x 3'-8"	3 x 2'-8"	1 x 7'-4"	2 x 3'-8"	3 x 2'-8"
2.75 (9)	1 x 7'-4"	2 x 3'-8"	3 x 2'-8"	1 x 7'-4"	2 x 3'-8"	3 x 2'-9"
3.05 (10)	1 x 7'-4"	2 x 3'-8"	3 x 2'-8"	1 x 7'-4"	2 x 4'-2"	3 x 3'-3"
3.66 (12)	1 x 7'-4"	2 x 3'-8"	3 x 2'-9"	1 x 7'-4"	2 x 4'-2"	3 x 3'-3"
4.27 (14)	1 x 7'-4"	2 x 4'-2"	3 x 3'-8"	1 x 7'-4"	2 x 4'-2"	3 x 3'-3"
4.88 (16)	1 x 7'-4"	2 x 4'-2"	3 x 3'-8"	1 x 7'-4"	2 x 4'-2"	3 x 3'-11"
<b>Main Floor Walls of Two Story Structure Supporting 2nd Story Wood Framed Walls, Floor and Roof (TYPE G)</b>						
	6" & 8" Thick Wall		10" & 12" Thick Wall		6" & 8" Thick Wall	
	Number and length of shear walls provided					
2.44 (8)	1 x 7'-4"	2 x 4'-7"	3 x 3'-8"	1 x 7'-4"	2 x 4'-7"	3 x 3'-8"
2.75 (9)	1 x 7'-4"	2 x 4'-7"	3 x 3'-8"	1 x 7'-8"	2 x 4'-11"	3 x 3'-8"
3.05 (10)	1 x 7'-12"	2 x 5'-3"	3 x 3'-12"	1 x 7'-10"	2 x 5'-1"	3 x 3'-12"
3.66 (12)	1 x 8'-7"	2 x 5'-10"	3 x 4'-7"	1 x 8'-7"	2 x 5'-10"	3 x 4'-7"
4.27 (14)	1 x 8'-11"	2 x 5'-12"	3 x 4'-11"	1 x 9'-6"	2 x 6'-5"	3 x 4'-11"
4.88 (16)	1 x 9'-2"	2 x 6'-5"	3 x 5'-1"	1 x 10'-7"	2 x 6'-11"	3 x 5'-6"
<b>Main Floor Walls of Two Story ICF Structure Supporting Wood Frame Floors and Roof (TYPE H)</b>						
	6" & 8" Thick Wall		10" & 12" Thick Wall		6" & 8" Thick Wall	
	Number and length of shear walls provided					
2.44 (8)	1 x 8'-7"	2 x 5'-6"	3 x 4'-4"	1 x 9'-2"	2 x 5'-10"	3 x 4'-7"
2.75 (9)	1 x 8'-11"	2 x 5'-12"	3 x 4'-4"	1 x 10'-1"	2 x 6'-5"	3 x 4'-11"
3.05 (10)	1 x 10'-1"	2 x 6'-5"	3 x 5'-1"	1 x 10'-1"	2 x 6'-5"	3 x 5'-1"
3.66 (12)	1 x 10'-7"	2 x 6'-11"	3 x 5'-6"	1 x 10'-7"	2 x 6'-11"	3 x 5'-6"
4.27 (14)	1 x 10'-7"	2 x 7'-4"	3 x 5'-12"	1 x 10'-7"	2 x 7'-8"	3 x 5'-12"
4.88 (16)	1 x 10'-7"	2 x 7'-4"	3 x 5'-12"	1 x 10'-7"	2 x 7'-8"	3 x 5'-12"
Vertical Reinforcement	ICF with 6" Tie Spacing	As per table A.1.1.		As per table A.1.1.		As per table A.1.1.
Vertical Reinforcement	ICF with 8" Tie Spacing	As per table A.1.2.		As per table A.1.2.		As per table A.1.2.
Horizontal Reinforcement	Block Height of 12" and 18"	10 M @ 450 (18)		10 M @ 450 (18)		10 M @ 450 (18)
Horizontal Reinforcement	Block Height of 16"	10 M @ 400 (16)		10 M @ 400 (16)		10 M @ 400 (16)

**NOTES:**

1.  $S_{a,ICF}$  is equivalent spectral response acceleration for ICF walls as provided in Appendix A.
2. This table is to be used in conjunction with the "Design Limitations."
3. Provide two layers of the indicated horizontal and vertical distributed steel specified for 300mm (12") walls. Place each layer as shown in the rebar placement drawing.
4. All four sides of the building are to have a minimum number and length of shear walls that conforms to this table.
5. Use Table A.6 for buildings that do not meet the required wall length of this table.
6. Provide 2-15M concentrated reinforcement at each end of shear walls as shown in shear wall detail.
7. All concentrated reinforcement is to be continues to the bottom of the foundation wall. Provide lap splices as required.
8. Concentrated reinforcement is to be placed in accordance with Bar Placement Detail.

INSULATING CONCRETE FORMS MANUFACTURERS ASSOCIATION

**Table A.10.2400. Above Grade Shear Wall Length for Seismic Zone Classification,  $S_{a,ICF} > 0.16$  and Hourly Wind Pressure,  $q_{1/50} \leq 1.05\text{kPa}$  (in a Building With Walkout Basement), where Building Area  $\leq 2400\text{ft}^2$**

Wall Height m (ft)	Seismic Zone Classification							
	$S_{a,ICF} \leq 0.16$		$S_{a,ICF} \leq 0.31$		$S_{a,ICF} \leq 0.53$		$S_{a,ICF} \leq 0.79$	
<b>Second Floor Walls of Two Story ICF Structure Supporting Wood Frame Roof (TYPE E)</b>								
	6" & 8" Thick Wall	10" & 12" Thick Wall	6" & 8" Thick Wall	10" & 12" Thick Wall	6" & 8" Thick Wall	10" & 12" Thick Wall	6" & 8" Thick Wall	10" & 12" Thick Wall
	Number and length of shear walls provided							
2.44 (8)	1x7'-4" 2x3'-8" 3x2'-9"	1x7'-4" 2x3'-8" 3x2'-9"	1x8'-3" 2x5'-6" 3x4'-2"	1x8'-3" 2x5'-6" 3x4'-2"	1x10'-1" 2x6'-11" 3x5'-6"	1x10'-7" 2x7'-4" 3x5'-10"	1x11'-6" 2x7'-10" 3x6'-5"	1x11'-6" 2x8'-3" 3x6'-5"
2.75 (9)	1x7'-4" 2x3'-8" 3x2'-9"	1x7'-4" 2x3'-8" 3x2'-9"	1x8'-3" 2x5'-6" 3x4'-2"	1x8'-3" 2x5'-6" 3x4'-2"	1x10'-1" 2x6'-11" 3x5'-6"	1x10'-7" 2x7'-4" 3x5'-10"	1x11'-6" 2x8'-3" 3x6'-5"	1x11'-6" 2x8'-3" 3x6'-5"
3.05 (10)	1x7'-4" 2x4'-2" 3x3'-3"	1x7'-4" 2x4'-2" 3x3'-3"	1x9'-2" 2x6'-5" 3x4'-7"	1x9'-2" 2x6'-5" 3x4'-7"	1x11'-6" 2x7'-10" 3x6'-5"	1x11'-6" 2x8'-3" 3x6'-5"	1x12'-5" 2x8'-9" 3x6'-11"	1x12'-11" 2x9'-2" 3x7'-4"
3.66 (12)	1x7'-4" 2x4'-2" 3x3'-3"	1x7'-4" 2x4'-2" 3x3'-3"	1x9'-2" 2x6'-5" 3x4'-7"	1x9'-2" 2x6'-5" 3x4'-7"	1x11'-6" 2x7'-10" 3x6'-5"	1x11'-6" 2x8'-3" 3x6'-5"	1x12'-5" 2x8'-9" 3x6'-11"	1x12'-11" 2x9'-2" 3x7'-4"
4.27 (14)	1x8'-3" 2x5'-10" 3x4'-7"	1x8'-3" 2x5'-10" 3x4'-7"	1x10'-1" 2x6'-11" 3x5'-6"	1x10'-1" 2x6'-11" 3x5'-6"	1x12'-5" 2x8'-9" 3x6'-11"	1x12'-11" 2x8'-9" 3x6'-11"	1x13'-10" 2x9'-8" 3x7'-10"	1x14'-3" 2x9'-8" 3x7'-10"
4.88 (16)	1x8'-3" 2x5'-10" 3x4'-7"	1x8'-3" 2x5'-10" 3x4'-7"	1x10'-1" 2x6'-11" 3x5'-6"	1x10'-1" 2x6'-11" 3x5'-6"	1x12'-5" 2x8'-9" 3x6'-11"	1x12'-11" 2x8'-9" 3x6'-11"	1x13'-10" 2x9'-8" 3x7'-10"	1x14'-3" 2x9'-8" 3x7'-10"
<b>Main Floor Walls of One Story ICF Structure Supporting Wood Frame Roof (TYPE F)</b>								
	6" & 8" Thick Wall	10" & 12" Thick Wall	6" & 8" Thick Wall	10" & 12" Thick Wall	6" & 8" Thick Wall	10" & 12" Thick Wall	6" & 8" Thick Wall	10" & 12" Thick Wall
	Number and length of shear walls provided							
2.44 (8)	1x7'-4" 2x3'-8" 3x2'-9"	1x7'-4" 2x3'-8" 3x2'-9"	1x8'-3" 2x5'-6" 3x4'-2"	1x8'-3" 2x5'-6" 3x4'-2"	1x10'-1" 2x6'-11" 3x5'-6"	1x10'-7" 2x7'-4" 3x5'-10"	1x11'-6" 2x7'-10" 3x6'-5"	1x11'-6" 2x7'-4" 3x5'-12"
2.75 (9)	1x7'-4" 2x3'-8" 3x2'-9"	1x7'-4" 2x3'-8" 3x2'-9"	1x8'-3" 2x5'-6" 3x4'-2"	1x8'-3" 2x5'-6" 3x4'-2"	1x10'-1" 2x6'-11" 3x5'-6"	1x10'-7" 2x7'-4" 3x5'-10"	1x11'-6" 2x8'-3" 3x6'-5"	1x11'-6" 2x8'-3" 3x6'-5"
3.05 (10)	1x7'-4" 2x4'-2" 3x3'-3"	1x7'-4" 2x4'-2" 3x3'-3"	1x9'-2" 2x6'-5" 3x4'-7"	1x9'-2" 2x6'-5" 3x4'-7"	1x11'-6" 2x7'-10" 3x6'-5"	1x11'-6" 2x8'-3" 3x6'-5"	1x12'-5" 2x8'-9" 3x6'-11"	1x12'-11" 2x9'-2" 3x7'-4"
3.66 (12)	1x7'-4" 2x4'-2" 3x3'-3"	1x7'-4" 2x4'-2" 3x3'-3"	1x9'-2" 2x6'-5" 3x4'-7"	1x9'-2" 2x6'-5" 3x4'-7"	1x11'-6" 2x7'-10" 3x6'-5"	1x11'-6" 2x8'-3" 3x6'-5"	1x12'-5" 2x8'-9" 3x6'-11"	1x12'-11" 2x9'-2" 3x7'-4"
4.27 (14)	1x8'-3" 2x5'-10" 3x4'-7"	1x8'-3" 2x5'-10" 3x4'-7"	1x10'-1" 2x6'-11" 3x5'-6"	1x10'-1" 2x6'-11" 3x5'-6"	1x12'-5" 2x8'-9" 3x6'-11"	1x12'-11" 2x8'-9" 3x6'-11"	1x13'-10" 2x9'-8" 3x7'-10"	1x14'-3" 2x9'-8" 3x7'-10"
4.88 (16)	1x8'-3" 2x5'-10" 3x4'-7"	1x8'-3" 2x5'-10" 3x4'-7"	1x10'-1" 2x6'-11" 3x5'-6"	1x10'-1" 2x6'-11" 3x5'-6"	1x12'-5" 2x8'-9" 3x6'-11"	1x12'-11" 2x8'-9" 3x6'-11"	1x13'-10" 2x9'-8" 3x7'-10"	1x14'-3" 2x9'-8" 3x7'-10"
<b>Main Floor Walls of Two Story Structure Supporting 2nd Story Wood Framed Walls, Floor and Roof (TYPE G)</b>								
	6" & 8" Thick Wall	10" & 12" Thick Wall	6" & 8" Thick Wall	10" & 12" Thick Wall	6" & 8" Thick Wall	10" & 12" Thick Wall	6" & 8" Thick Wall	10" & 12" Thick Wall
	Number and length of shear walls provided							
2.44 (8)	1x9'-2" 2x5'-12" 3x4'-7"	1x9'-2" 2x5'-12" 3x4'-7"	1x12'-11" 2x8'-9" 3x6'-11"	1x12'-11" 2x8'-9" 3x6'-11"	1x17'-6" 2x11'-12" 3x10'-1"	1x17'-6" 2x11'-12" 3x10'-1"	1x18'-5" 2x12'-11" 3x11'-0"	1x18'-5" 2x12'-11" 3x11'-0"
2.75 (9)	1x10'-1" 2x6'-5" 3x5'-6"	1x10'-1" 2x6'-5" 3x5'-6"	1x13'-10" 2x9'-2" 3x7'-4"	1x13'-10" 2x9'-2" 3x7'-4"	1x18'-10" 2x12'-11" 3x10'-1"	1x18'-10" 2x12'-11" 3x10'-1"	1x18'-5" 2x12'-11" 3x11'-0"	1x18'-5" 2x12'-11" 3x11'-0"
3.05 (10)	1x10'-1" 2x6'-11" 3x5'-6"	1x10'-1" 2x6'-11" 3x5'-6"	1x14'-9" 2x10'-1" 3x7'-10"	1x14'-9" 2x10'-1" 3x7'-10"	1x19'-9" 2x13'-4" 3x10'-7"	1x19'-9" 2x13'-4" 3x10'-7"	1x20'-3" 2x13'-10" 3x11'-0"	1x20'-3" 2x13'-10" 3x11'-0"
3.66 (12)	1x10'-7" 2x7'-4" 3x5'-10"	1x11'-12" 2x8'-3" 3x6'-5"	1x14'-9" 2x10'-1" 3x7'-10"	1x14'-9" 2x10'-1" 3x7'-10"	1x19'-9" 2x13'-4" 3x10'-7"	1x19'-9" 2x13'-10" 3x11'-0"	1x22'-1" 2x15'-2" 3x12'-11"	1x22'-1" 2x15'-2" 3x12'-11"
4.27 (14)	1x11'-6" 2x7'-10" 3x6'-5"	1x11'-12" 2x8'-3" 3x6'-5"	1x16'-1" 2x11'-0" 3x9'-2"	1x16'-1" 2x11'-0" 3x9'-2"	1x22'-1" 2x15'-2" 3x11'-12"	1x22'-1" 2x15'-2" 3x11'-12"	1x23'-11" 2x16'-7" 3x13'-10"	1x23'-11" 2x16'-7" 3x13'-10"
4.88 (16)	1x11'-6" 2x7'-10" 3x6'-5"	1x11'-12" 2x8'-3" 3x6'-5"	1x16'-1" 2x11'-0" 3x9'-2"	1x16'-1" 2x11'-0" 3x9'-2"	1x22'-1" 2x15'-2" 3x11'-12"	1x22'-1" 2x15'-2" 3x11'-12"	1x23'-11" 2x16'-7" 3x13'-10"	1x23'-11" 2x16'-7" 3x13'-10"
<b>Main floor Walls of Two Story ICF Structure Supporting Wood Frame Floors and Roof (TYPE H)</b>								
	6" & 8" Thick Wall	10" & 12" Thick Wall	6" & 8" Thick Wall	10" & 12" Thick Wall	6" & 8" Thick Wall	10" & 12" Thick Wall	6" & 8" Thick Wall	10" & 12" Thick Wall
	Number and length of shear walls provided							
2.44 (8)	1x11'-0" 2x7'-4" 3x5'-12"	1x11'-6" 2x7'-10" 3x5'-12"	1x15'-8" 2x11'-0" 3x8'-3"	1x16'-0" 2x11'-0" 3x8'-9"	1x19'-4" 2x13'-10" 3x11'-0"	1x20'-3" 2x13'-10" 3x11'-0"	1x21'-2" 2x14'-9" 3x12'-11"	1x22'-1" 2x15'-8" 3x12'-11"
2.75 (9)	1x11'-12" 2x8'-3" 3x6'-5"	1x11'-12" 2x8'-3" 3x6'-5"	1x16'-7" 2x11'-12" 3x9'-2"	1x18'-5" 2x11'-12" 3x9'-2"	1x20'-3" 2x13'-10" 3x11'-12"	1x21'-2" 2x14'-9" 3x12'-11"	1x22'-1" 2x15'-8" 3x12'-11"	1x23'-0" 2x16'-7" 3x12'-11"
3.05 (10)	1x12'-11" 2x8'-3" 3x6'-5"	1x12'-11" 2x8'-3" 3x6'-5"	1x17'-6" 2x11'-12" 3x10'-1"	1x18'-5" 2x11'-12" 3x10'-1"	1x21'-2" 2x14'-9" 3x12'-11"	1x21'-2" 2x14'-9" 3x12'-11"	1x23'-11" 2x16'-7" 3x13'-10"	1x24'-10" 2x17'-6" 3x13'-10"
3.66 (12)	1x12'-11" 2x8'-9" 3x6'-11"	1x14'-9" 2x10'-1" 3x7'-10"	1x18'-5" 2x11'-12" 3x10'-1"	1x21'-2" 2x14'-9" 3x12'-11"	1x23'-0" 2x16'-7" 3x13'-10"	1x23'-11" 2x16'-7" 3x13'-10"	1x25'-9" 2x18'-5" 3x14'-9"	1x27'-7" 2x18'-5" 3x14'-9"
4.27 (14)	1x13'-10" 2x9'-2" 3x7'-4"	1x14'-9" 2x10'-1" 3x7'-10"	1x19'-4" 2x13'-10" 3x11'-0"	1x21'-2" 2x14'-9" 3x12'-11"	1x25'-9" 2x17'-6" 3x14'-3"	1x26'-4" 2x18'-5" 3x14'-9"	1x28'-6" 2x19'-4" 3x15'-8"	1x29'-5" 2x20'-3" 3x16'-7"
4.88 (16)	1x13'-10" 2x9'-2" 3x7'-4"	1x15'-8" 2x10'-4" 3x8'-3"	1x19'-4" 2x13'-10" 3x11'-0"	1x21'-2" 2x14'-9" 3x12'-11"	1x25'-9" 2x17'-6" 3x14'-3"	1x26'-4" 2x18'-5" 3x14'-9"	1x31'-3" 2x21'-2" 3x17'-6"	1x31'-6" 2x22'-1" 3x18'-5"
Vertical Reinforcement	ICF with 6" Tie Spacing	As per table A.2.1	As per table A.2.1	As per table A.2.1	As per table A.2.1	As per table A.2.1	As per table A.2.1	As per table A.2.1
ICF with 8" Tie Spacing	As per table A.2.2	As per table A.2.2	As per table A.2.2	As per table A.2.2	As per table A.2.2	As per table A.2.2	As per table A.2.2	As per table A.2.2
Horizontal Reinforcement	Block Height of 12" and 18"	As per table A.2.1	As per table A.2.1	As per table A.2.1	As per table A.2.1	As per table A.2.1	As per table A.2.1	As per table A.2.1
Block Height of 10"	As per table A.2.2	As per table A.2.2	As per table A.2.2	As per table A.2.2	As per table A.2.2	As per table A.2.2	As per table A.2.2	As per table A.2.2

**NOTES:**

1.  $S_{a,ICF}$  is equivalent spectral response acceleration for ICF walls as provided in Appendix A.
2. This table is to be used in conjunction with the "Design Limitations."
3. Provide two layers of the indicated horizontal and vertical distributed steel specified for 300mm (12") walls. Place each layer as shown in the rebar placement drawing.
4. All four sides of the building are to have a minimum number and length of shear walls that conforms to this table.
5. Provide 2-15M concentrated reinforcement at each end of shear walls as shown in shear wall detail.
6. All concentrated reinforcement is to be continues to the bottom of the foundation wall. Provide lap splices as required.
7. Concentrated reinforcement is to be placed in accordance with Bar Placement Detail.
8. Horizontal reinforcement in shear walls where  $S_{a,ICF} > 0.16$  must be anchored using a standard 180° hook around vertical end bars.
9. When using this table for  $S_{a,ICF} \leq 0.16$ , use the vertical and horizontal distributed steel in Tables A.2.1, or A.2.2.

INSULATING CONCRETE FORMS MANUFACTURERS ASSOCIATION

**Table A. 11.2400. – Above Grade Walkout Basement Shear Wall Length for Seismic Zone Classification,  $S_{a,ICF} \leq 0.31$  and Hourly Wind Pressure,  $q_{1/50} \leq 1.05kPa$ , where Building Area  $\leq 2400ft^2$**

Wall Height m (ft)	Seismic Zone Classification							
	$S_{a,ICF} \leq 0.07$		$S_{a,ICF} \leq 0.11$		$S_{a,ICF} \leq 0.16$		$S_{a,ICF} \leq 0.31$	
Walkout Basement Wall of a Single Story ICF Structure Supporting Wood Framed Roof (TYPE W1)								
	6" & 8" Thick Wall	10" & 12" Thick Wall	6" & 8" Thick Wall	10" & 12" Thick Wall	6" & 8" Thick Wall	10" & 12" Thick Wall	6" & 8" Thick Wall	10" & 12" Thick Wall
	Number and length of shear walls provided							
2.44 (8)	1x7'-0" 2x5'-1" 3x4'-2"	1x7'-10" 2x5'-6" 3x4'-2"	1x9'-2" 2x6'-5" 3x5'-1"	1x9'-8" 2x6'-11" 3x5'-6"	1x11'-6" 2x7'-10" 3x6'-5"	1x11'-12" 2x8'-3" 3x6'-5"	1x16'-7" 2x11'-6" 3x9'-2"	1x17'-6" 2x11'-12" 3x9'-3"
2.75 (9)	1x7'-5" 2x5'-1" 3x4'-2"	1x8'-3" 2x5'-6" 3x4'-7"	1x9'-8" 2x6'-6" 3x5'-6"	1x10'-1" 2x6'-11" 3x5'-6"	1x11'-6" 2x8'-3" 3x6'-5"	1x12'-3" 2x8'-3" 3x6'-9"	1x16'-7" 2x11'-6" 3x9'-2"	1x17'-6" 2x11'-12" 3x9'-8"
3.05 (10)	1x7'-10" 2x5'-6" 3x4'-2"	1x8'-3" 2x5'-12" 3x4'-7"	1x9'-9" 2x6'-11" 3x5'-6"	1x10'-2" 2x7'-0" 3x5'-8"	1x11'-12" 2x8'-3" 3x6'-11"	1x12'-6" 2x8'-9" 3x6'-11"	1x17'-0" 2x11'-12" 3x9'-8"	1x17'-11" 2x12'-5" 3x10'-1"
3.66 (12)	1x8'-3" 2x5'-6" 3x4'-7"	1x9'-2" 2x5'-12" 3x5'-1"	1x10'-5" 2x7'-4" 3x5'-12"	1x11'-0" 2x7'-4" 3x5'-12"	1x12'-6" 2x8'-9" 3x7'-4"	1x13'-4" 2x9'-2" 3x7'-4"	1x17'-11" 2x12'-5" 3x10'-1"	1x19'-4" 2x13'-0" 3x10'-7"
Walkout Basement Walls of a Two Story Wood Framed Structure Supporting Wood Frame Floors and Roof (TYPE W2)								
	6" & 8" Thick Wall	10" & 12" Thick Wall	6" & 8" Thick Wall	10" & 12" Thick Wall	6" & 8" Thick Wall	10" & 12" Thick Wall	6" & 8" Thick Wall	10" & 12" Thick Wall
	Number and length of shear walls provided							
2.44 (8)	1x9'-0" 2x6'-3" 3x5'-0"	1x9'-0" 2x6'-3" 3x5'-0"	1x9'-8" 2x6'-11" 3x5'-6"	1x9'-8" 2x6'-11" 3x5'-6"	1x11'-12" 2x8'-3" 3x6'-5"	1x11'-12" 2x8'-3" 3x6'-5"	1x16'-7" 2x11'-6" 3x9'-2"	1x16'-7" 2x11'-6" 3x9'-2"
2.75 (9)	1x9'-3" 2x6'-3" 3x5'-1"	1x9'-3" 2x6'-3" 3x5'-1"	1x10'-1" 2x7'-4" 3x5'-6"	1x10'-1" 2x7'-4" 3x5'-6"	1x11'-12" 2x8'-7" 3x6'-9"	1x11'-12" 2x8'-7" 3x6'-9"	1x17'-0" 2x11'-12" 3x9'-6"	1x17'-0" 2x11'-12" 3x9'-6"
3.05 (10)	1x9'-6" 2x6'-5" 3x5'-3"	1x9'-6" 2x6'-5" 3x5'-3"	1x10'-1" 2x7'-4" 3x5'-6"	1x10'-1" 2x7'-4" 3x5'-6"	1x12'-5" 2x8'-7" 3x6'-9"	1x12'-5" 2x8'-7" 3x6'-9"	1x17'-6" 2x12'-3" 3x9'-8"	1x17'-6" 2x12'-3" 3x9'-8"
3.66 (12)	1x10'-0" 2x7'-0" 3x5'-6"	1x10'-0" 2x7'-0" 3x5'-6"	1x10'-7" 2x7'-4" 3x5'-12"	1x10'-7" 2x7'-4" 3x5'-12"	1x12'-11" 2x8'-9" 3x7'-1"	1x12'-11" 2x8'-9" 3x7'-1"	1x17'-11" 2x12'-5" 3x10'-1"	1x17'-11" 2x12'-5" 3x10'-1"
Walkout Basement Wall of a Two Story Building with Main Floor ICF Walls Supporting 2nd Story Wood Framed Walls, Floor and Roof (TYPE W3)								
	6" & 8" Thick Wall	10" & 12" Thick Wall	6" & 8" Thick Wall	10" & 12" Thick Wall	6" & 8" Thick Wall	10" & 12" Thick Wall	6" & 8" Thick Wall	10" & 12" Thick Wall
	Number and length of shear walls provided							
2.44 (8)	1x9'-2" 2x6'-5" 3x5'-3"	1x9'-2" 2x6'-9" 3x5'-3"	1x11'-6" 2x8'-3" 3x6'-5"	1x11'-6" 2x8'-3" 3x6'-5"	1x13'-10" 2x9'-8" 3x7'-12"	1x14'-3" 2x9'-8" 3x7'-12"	1x19'-4" 2x13'-10" 3x11'-0"	1x20'-3" 2x13'-10" 3x11'-0"
2.75 (9)	1x9'-2" 2x6'-9" 3x5'-3"	1x9'-2" 2x6'-9" 3x5'-3"	1x11'-6" 2x8'-3" 3x6'-5"	1x11'-12" 2x8'-3" 3x6'-5"	1x14'-9" 2x9'-8" 3x7'-12"	1x14'-9" 2x10'-1" 3x7'-12"	1x19'-9" 2x13'-10" 3x11'-4"	1x20'-3" 2x14'-3" 3x11'-4"
3.05 (10)	1x9'-6" 2x6'-9" 3x5'-3"	1x9'-8" 2x6'-9" 3x5'-3"	1x11'-12" 2x8'-3" 3x6'-9"	1x11'-12" 2x8'-3" 3x6'-9"	1x14'-9" 2x10'-1" 3x7'-12"	1x14'-9" 2x10'-1" 3x8'-3"	1x20'-3" 2x14'-3" 3x11'-4"	1x20'-8" 2x14'-3" 3x11'-6"
3.66 (12)	1x10'-1" 2x7'-0" 3x5'-6"	1x10'-1" 2x7'-0" 3x5'-6"	1x12'-5" 2x8'-9" 3x6'-11"	1x12'-5" 2x8'-9" 3x6'-11"	1x15'-0" 2x10'-5" 3x8'-3"	1x15'-2" 2x10'-7" 3x8'-7"	1x21'-2" 2x14'-9" 3x11'-12"	1x21'-7" 2x15'-2" 3x12'-0"
Walkout Basement Wall of Two Story ICF Structure Supporting Wood Frame Floors and Roof (TYPE W4)								
	6" & 8" Thick Wall	10" & 12" Thick Wall	6" & 8" Thick Wall	10" & 12" Thick Wall	6" & 8" Thick Wall	10" & 12" Thick Wall	6" & 8" Thick Wall	10" & 12" Thick Wall
	Number and length of shear walls provided							
2.44 (8)	1x10'-3" 2x7'-0" 3x5'-10"	1x11'-0" 2x7'-4" 3x5'-10"	1x12'-11" 2x9'-2" 3x7'-4"	1x13'-6" 2x9'-2" 3x7'-6"	1x15'-8" 2x11'-0" 3x8'-9"	1x16'-7" 2x11'-6" 3x9'-2"	1x22'-1" 2x15'-8" 3x12'-5"	1x23'-3" 2x16'-7" 3x13'-0"
2.75 (9)	1x10'-7" 2x7'-4" 3x5'-10"	1x11'-0" 2x7'-4" 3x5'-12"	1x13'-10" 2x9'-2" 3x7'-4"	1x13'-10" 2x9'-8" 3x7'-10"	1x16'-7" 2x11'-1" 3x9'-2"	1x16'-9" 2x11'-8" 3x9'-4"	1x23'-0" 2x15'-9" 3x12'-11"	1x23'-11" 2x16'-7" 3x13'-4"
3.05 (10)	1x10'-7" 2x7'-4" 3x5'-10"	1x11'-0" 2x7'-8" 3x6'-3"	1x13'-10" 2x9'-3" 3x7'-10"	1x14'-0" 2x9'-8" 3x7'-10"	1x16'-7" 2x11'-6" 3x9'-2"	1x17'-1" 2x11'-12" 3x9'-8"	1x23'-0" 2x16'-7" 3x13'-0"	1x24'-3" 2x16'-9" 3x13'-10"
3.66 (12)	1x11'-0" 2x7'-8" 3x6'-2"	1x11'-6" 2x7'-10" 3x6'-5"	1x14'-0" 2x9'-8" 3x7'-10"	1x14'-9" 2x10'-1" 3x8'-3"	1x17'-11" 2x12'-5" 3x10'-1"	1x17'-11" 2x12'-5" 3x10'-1"	1x23'-11" 2x16'-8" 3x13'-6"	1x25'-3" 2x17'-6" 3x14'-3"
Vertical Reinforcement	6", 8" and 10" thick wall	15 M @ 300 (12)	10 M @ 300 (12)	15 M @ 300 (12)	15 M @ 300 (12)	10 M @ 300 (12)	15 M @ 300 (12)	15 M @ 300 (12)
Horizontal Reinforcement	Block Height of 12" and 18"	10 M @ 450 (18)	10 M @ 450 (18)	10 M @ 450 (18)	10 M @ 450 (18)	10 M @ 450 (18)	10 M @ 450 (18)	10 M @ 450 (18)
Reinforcement	Block Height of 16"	10 M @ 400 (16)	10 M @ 400 (16)	10 M @ 400 (16)	10 M @ 400 (16)	10 M @ 400 (16)	10 M @ 400 (16)	10 M @ 400 (16)

**NOTES:**

1.  $S_{a,ICF}$  is equivalent spectral response acceleration for ICF walls as provided in Appendix A.
2. This table is to be used in conjunction with the "Design Limitations."
3. Provide two layers of the indicated horizontal and vertical distributed steel specified for 300mm (12") walls. Place each layer as shown in the rebar placement drawing.
4. All four sides of the building are to have a minimum number and length of shear walls that conforms to this table.
5. Provide 2-15M concentrated reinforcement at each end of shear walls as shown in shear wall detail.
6. All concentrated reinforcement is to be continues to the bottom of the foundation wall. Provide lap splices as required.
7. Concentrated reinforcement is to be placed in accordance with Bar Placement Detail.
8. Horizontal reinforcement in shear walls where  $S_{a,ICF} > 0.16$  must be anchored using a standard 180° hook around vertical end bars.
9. Walkout basement shear walls are to be reviewed and designed by a structural engineer where  $S_{a,ICF} > 0.31$ .

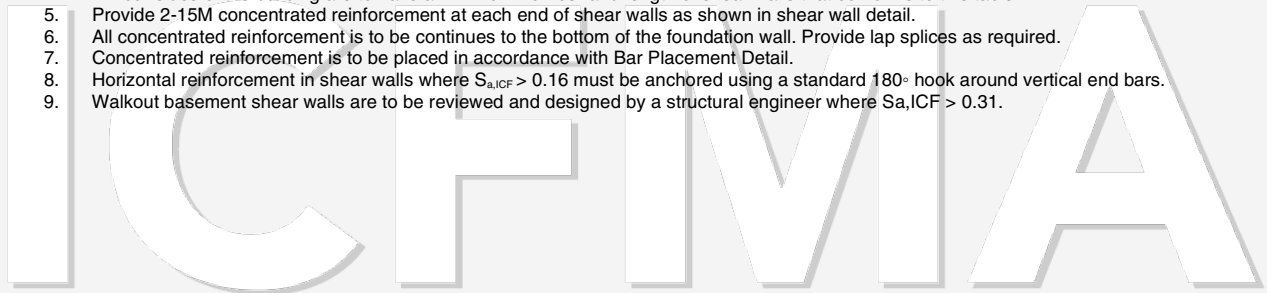

# INSULATING CONCRETE FORMS MANUFACTURERS ASSOCIATION

**Table A.3.1600. Above Grade Shear Wall Length for Seismic Zone Classification,  $S_{a,ICF} \leq 0.16$  and Hourly Wind Pressure,  $q_{1/50} \leq 0.5kPa$  (in a Building Without Walkout Basement), where Building Area  $\leq 1600ft^2$**

Wall Height m (ft)	Seismic Zone Classification																		
	$S_{a,ICF} \leq 0.07$		$S_{a,ICF} \leq 0.11$		$S_{a,ICF} \leq 0.16$														
<b>Second Floor Walls of Two Story ICF Structure Supporting Wood Frame Roof (TYPE A)</b>																			
	6" & 8" Thick Wall		10" & 12" Thick Wall		6" & 8" Thick Wall		10" & 12" Thick Wall		6" & 8" Thick Wall		10" & 12" Thick Wall								
	Number and length of shear walls provided																		
2.44 (8)	1 x 6'-5"	2 x 3'-2"	3 x 2'-8"	1 x 6'-5"	2 x 3'-2"	3 x 2'-8"	1 x 6'-5"	2 x 3'-2"	3 x 2'-8"	1 x 6'-5"	2 x 3'-2"	3 x 2'-8"	1 x 6'-5"	2 x 3'-2"	3 x 2'-8"				
2.75 (9)	1 x 6'-5"	2 x 3'-2"	3 x 2'-8"	1 x 6'-5"	2 x 3'-2"	3 x 2'-8"	1 x 6'-5"	2 x 3'-2"	3 x 2'-8"	1 x 6'-5"	2 x 3'-2"	3 x 2'-8"	1 x 6'-5"	2 x 3'-2"	3 x 2'-8"				
3.05 (10)	1 x 6'-5"	2 x 3'-2"	3 x 2'-8"	1 x 6'-5"	2 x 3'-2"	3 x 2'-8"	1 x 6'-5"	2 x 3'-2"	3 x 2'-8"	1 x 6'-5"	2 x 3'-2"	3 x 2'-8"	1 x 6'-5"	2 x 3'-2"	3 x 2'-8"				
<b>Main Floor Walls of One Story ICF Structure Supporting Wood Frame Roof (TYPE B)</b>																			
	6" & 8" Thick Wall		10" & 12" Thick Wall		6" & 8" Thick Wall		10" & 12" Thick Wall		6" & 8" Thick Wall		10" & 12" Thick Wall								
	Number and length of shear walls provided																		
2.44 (8)	1 x 6'-5"	2 x 3'-2"	3 x 2'-8"	1 x 6'-5"	2 x 3'-2"	3 x 2'-8"	1 x 6'-5"	2 x 3'-2"	3 x 2'-8"	1 x 6'-5"	2 x 3'-2"	3 x 2'-8"	1 x 6'-5"	2 x 3'-2"	3 x 2'-8"				
2.75 (9)	1 x 6'-5"	2 x 3'-2"	3 x 2'-8"	1 x 6'-5"	2 x 3'-2"	3 x 2'-8"	1 x 6'-5"	2 x 3'-2"	3 x 2'-8"	1 x 6'-5"	2 x 3'-2"	3 x 2'-8"	1 x 6'-5"	2 x 3'-2"	3 x 2'-8"				
3.05 (10)	1 x 6'-5"	2 x 3'-2"	3 x 2'-8"	1 x 6'-5"	2 x 3'-2"	3 x 2'-8"	1 x 6'-5"	2 x 3'-2"	3 x 2'-8"	1 x 6'-5"	2 x 3'-2"	3 x 2'-8"	1 x 6'-5"	2 x 3'-2"	3 x 2'-8"				
3.66 (12)	1 x 6'-5"	2 x 3'-2"	3 x 2'-8"	1 x 6'-5"	2 x 3'-2"	3 x 2'-8"	1 x 6'-5"	2 x 3'-2"	3 x 2'-8"	1 x 6'-5"	2 x 3'-2"	3 x 2'-8"	1 x 6'-5"	2 x 3'-2"	3 x 2'-8"				
4.27 (14)	1 x 6'-5"	2 x 3'-2"	3 x 2'-8"	1 x 6'-5"	2 x 3'-2"	3 x 2'-8"	1 x 6'-5"	2 x 3'-2"	3 x 2'-8"	1 x 6'-5"	2 x 3'-2"	3 x 2'-8"	1 x 6'-5"	2 x 3'-2"	3 x 2'-8"				
4.88 (16)	1 x 6'-5"	2 x 3'-2"	3 x 2'-8"	1 x 6'-5"	2 x 3'-2"	3 x 2'-8"	1 x 6'-5"	2 x 3'-2"	3 x 2'-8"	1 x 6'-5"	2 x 3'-2"	3 x 2'-8"	1 x 6'-5"	2 x 3'-2"	3 x 2'-8"				
<b>Main Floor Walls of Two Story Structure Supporting 2nd Story Wood Framed Walls, Floor and Roof (TYPE C)</b>																			
	6" & 8" Thick Wall		10" & 12" Thick Wall		6" & 8" Thick Wall		10" & 12" Thick Wall		6" & 8" Thick Wall		10" & 12" Thick Wall								
	Number and length of shear walls provided																		
2.44 (8)	1 x 6'-5"	2 x 3'-2"	3 x 2'-8"	1 x 6'-5"	2 x 3'-2"	3 x 2'-8"	1 x 7'-2"	2 x 4'-10"	3 x 4'-0"	1 x 7'-2"	2 x 5'-2"	3 x 4'-0"	1 x 8'-10"	2 x 5'-7"	3 x 4'-5"				
2.75 (9)	1 x 6'-5"	2 x 3'-2"	3 x 2'-8"	1 x 6'-5"	2 x 3'-2"	3 x 2'-8"	1 x 7'-2"	2 x 5'-2"	3 x 4'-0"	1 x 8'-0"	2 x 5'-7"	3 x 4'-0"	1 x 8'-0"	2 x 5'-7"	3 x 4'-0"				
3.05 (10)	1 x 6'-5"	2 x 3'-2"	3 x 2'-8"	1 x 6'-5"	2 x 3'-2"	3 x 2'-8"	1 x 7'-2"	2 x 5'-2"	3 x 4'-0"	1 x 8'-0"	2 x 5'-7"	3 x 4'-0"	1 x 8'-0"	2 x 5'-7"	3 x 4'-0"				
3.66 (12)	1 x 6'-5"	2 x 3'-2"	3 x 2'-8"	1 x 6'-5"	2 x 3'-2"	3 x 2'-8"	1 x 7'-2"	2 x 5'-2"	3 x 4'-0"	1 x 8'-0"	2 x 5'-7"	3 x 4'-0"	1 x 8'-0"	2 x 5'-7"	3 x 4'-0"				
4.27 (14)	1 x 6'-5"	2 x 3'-2"	3 x 2'-8"	1 x 6'-5"	2 x 3'-2"	3 x 2'-8"	1 x 7'-2"	2 x 5'-2"	3 x 4'-0"	1 x 8'-0"	2 x 5'-7"	3 x 4'-0"	1 x 8'-0"	2 x 5'-7"	3 x 4'-0"				
4.88 (16)	1 x 6'-5"	2 x 3'-2"	3 x 2'-8"	1 x 6'-5"	2 x 3'-2"	3 x 2'-8"	1 x 7'-2"	2 x 5'-2"	3 x 4'-0"	1 x 8'-0"	2 x 5'-7"	3 x 4'-0"	1 x 8'-0"	2 x 5'-7"	3 x 4'-0"				
<b>Main Floor Walls of Two Story ICF Structure Supporting Wood Frame Floors and Roof (TYPE D)</b>																			
	6" & 8" Thick Wall		10" & 12" Thick Wall		6" & 8" Thick Wall		10" & 12" Thick Wall		6" & 8" Thick Wall		10" & 12" Thick Wall								
	Number and length of shear walls provided																		
2.44 (8)	1 x 7'-2"	2 x 4'-5"	3 x 3'-2"	1 x 7'-2"	2 x 4'-5"	3 x 3'-2"	1 x 8'-10"	2 x 5'-7"	3 x 4'-5"	1 x 9'-7"	2 x 6'-5"	3 x 4'-10"	1 x 11'-2"	2 x 7'-2"	3 x 5'-7"				
2.75 (9)	1 x 7'-2"	2 x 4'-5"	3 x 3'-2"	1 x 8'-0"	2 x 4'-10"	3 x 4'-0"	1 x 9'-7"	2 x 6'-0"	3 x 4'-10"	1 x 10'-5"	2 x 6'-5"	3 x 4'-10"	1 x 12'-0"	2 x 7'-7"	3 x 6'-5"				
3.05 (10)	1 x 7'-2"	2 x 4'-5"	3 x 3'-2"	1 x 8'-0"	2 x 4'-10"	3 x 4'-0"	1 x 10'-5"	2 x 6'-5"	3 x 4'-10"	1 x 10'-5"	2 x 6'-10"	3 x 5'-7"	1 x 12'-5"	2 x 8'-0"	3 x 6'-5"				
3.66 (12)	1 x 8'-0"	2 x 5'-7"	3 x 4'-0"	1 x 8'-0"	2 x 5'-7"	3 x 4'-0"	1 x 10'-5"	2 x 7'-2"	3 x 5'-7"	1 x 10'-10"	2 x 7'-2"	3 x 5'-7"	1 x 12'-10"	2 x 8'-10"	3 x 7'-2"				
4.27 (14)	1 x 8'-0"	2 x 5'-7"	3 x 4'-0"	1 x 8'-10"	2 x 4'-5"	3 x 3'-2"	1 x 10'-5"	2 x 7'-2"	3 x 5'-7"	1 x 11'-7"	2 x 7'-7"	3 x 6'-5"	1 x 12'-10"	2 x 8'-10"	3 x 7'-2"				
4.88 (16)	1 x 8'-0"	2 x 5'-7"	3 x 4'-0"	1 x 9'-2"	2 x 4'-10"	3 x 4'-0"	1 x 10'-5"	2 x 7'-2"	3 x 5'-7"	1 x 11'-9"	2 x 8'-0"	3 x 6'-5"	1 x 12'-10"	2 x 8'-10"	3 x 7'-2"				
Vertical Reinforcement	ICF with 6" Tie Spacing	As per table A.1.1.					As per table A.1.1.					As per table A.1.1.							
Vertical Reinforcement	ICF with 8" Tie Spacing	As per table A.1.2.					As per table A.1.2.					As per table A.1.2.							
Horizontal Reinforcement	Block Height of 12" and 18"	10 M @	450 (18)					10 M @	450 (18)					10 M @	450 (18)				
Horizontal Reinforcement	Block Height of 16"	10 M @	400 (16)					10 M @	400 (16)					10 M @	400 (16)				

**NOTES:**

- $S_{a,ICF}$  is equivalent spectral response acceleration for ICF walls as provided in Appendix A.
- This table is to be used in conjunction with the "Design Limitations."
- Provide two layers of the indicated horizontal and vertical distributed steel specified for 300mm (12") walls. Place each layer as shown in the rebar placement drawing.
- All four sides of the building are to have a minimum number and length of shear walls that conforms to this table.
- Use Table A.6 for buildings that do not meet the required wall length of this table.
- Provide 2-15M concentrated reinforcement at each end of shear walls as shown in shear wall detail.
- All concentrated reinforcement is to be continued to the bottom of the foundation wall. Provide lap splices as required.
- Concentrated reinforcement is to be placed in accordance with Bar Placement Detail.

**INSULATING CONCRETE FORMS MANUFACTURERS ASSOCIATION**

**Table A.4.1600. Above Grade Shear Wall Length for Seismic Zone Classification,  $S_{a,ICF} \leq 0.16$  and Hourly Wind Pressure,  $0.5kPa < q1/50 \leq 0.75kPa$  (in a Building Without Walkout Basement), where Building Area  $\leq 1600ft^2$**

Wall Height m (ft)	Seismic Zone Classification					
	$S_{a,ICF} \leq 0.07$		$S_{a,ICF} \leq 0.11$		$S_{a,ICF} \leq 0.16$	
<b>Second Floor Walls of Two Story ICF Structure Supporting Wood Frame Roof (TYPE A)</b>						
	6" & 8" Thick Wall		10" & 12" Thick Wall		6" & 8" Thick Wall	
	Number and length of shear walls provided					
2.44 (8)	1 x 6'-5"	2 x 3'-2"	3 x 2'-8"	1 x 6'-5"	2 x 3'-2"	3 x 2'-8"
2.75 (9)	1 x 6'-5"	2 x 3'-2"	3 x 2'-8"	1 x 6'-5"	2 x 3'-2"	3 x 2'-8"
3.05 (10)	1 x 6'-5"	2 x 3'-2"	3 x 2'-8"	1 x 6'-5"	2 x 3'-2"	3 x 2'-8"
3.66 (12)	1 x 6'-5"	2 x 3'-2"	3 x 2'-8"	1 x 6'-5"	2 x 3'-2"	3 x 2'-8"
4.27 (14)	1 x 6'-5"	2 x 3'-2"	3 x 2'-8"	1 x 6'-5"	2 x 3'-2"	3 x 2'-8"
4.88 (16)	1 x 6'-5"	2 x 3'-2"	3 x 2'-8"	1 x 6'-5"	2 x 3'-2"	3 x 2'-8"
<b>Main Floor Walls of One Story ICF Structure Supporting Wood Frame Roof (TYPE B)</b>						
	6" & 8" Thick Wall		10" & 12" Thick Wall		6" & 8" Thick Wall	
	Number and length of shear walls provided					
2.44 (8)	1 x 6'-5"	2 x 3'-2"	3 x 2'-8"	1 x 6'-5"	2 x 3'-2"	3 x 2'-8"
2.75 (9)	1 x 6'-5"	2 x 3'-2"	3 x 2'-8"	1 x 6'-5"	2 x 3'-2"	3 x 2'-8"
3.05 (10)	1 x 6'-5"	2 x 3'-2"	3 x 2'-8"	1 x 6'-5"	2 x 3'-2"	3 x 2'-8"
3.66 (12)	1 x 6'-5"	2 x 3'-2"	3 x 2'-8"	1 x 6'-5"	2 x 3'-2"	3 x 2'-8"
4.27 (14)	1 x 6'-5"	2 x 3'-2"	3 x 2'-8"	1 x 6'-5"	2 x 3'-2"	3 x 2'-8"
4.88 (16)	1 x 6'-5"	2 x 3'-2"	3 x 2'-8"	1 x 6'-5"	2 x 3'-2"	3 x 2'-8"
<b>Main Floor Walls of Two Story Structure Supporting 2nd Story Wood Framed Walls, Floor and Roof (TYPE C)</b>						
	6" & 8" Thick Wall		10" & 12" Thick Wall		6" & 8" Thick Wall	
	Number and length of shear walls provided					
2.44 (8)	1 x 6'-5"	2 x 3'-2"	3 x 2'-8"	1 x 7'-2"	2 x 4'-10"	3 x 4'-0"
2.75 (9)	1 x 6'-5"	2 x 3'-2"	3 x 2'-8"	1 x 7'-2"	2 x 5'-2"	3 x 4'-0"
3.05 (10)	1 x 6'-5"	2 x 3'-2"	3 x 2'-8"	1 x 8'-0"	2 x 5'-2"	3 x 4'-0"
3.66 (12)	1 x 6'-5"	2 x 3'-2"	3 x 2'-8"	1 x 8'-0"	2 x 5'-10"	3 x 4'-10"
4.27 (14)	1 x 6'-10"	2 x 4'-5"	3 x 3'-2"	1 x 8'-5"	2 x 6'-8"	3 x 5'-2"
4.88 (16)	1 x 6'-10"	2 x 4'-5"	3 x 3'-2"	1 x 8'-5"	2 x 6'-8"	3 x 5'-2"
<b>Main Floor Walls of Two Story ICF Structure Supporting Wood Frame Floors and Roof (TYPE D)</b>						
	6" & 8" Thick Wall		10" & 12" Thick Wall		6" & 8" Thick Wall	
	Number and length of shear walls provided					
2.44 (8)	1 x 7'-2"	2 x 4'-5"	3 x 3'-7"	1 x 8'-10"	2 x 5'-7"	3 x 4'-5"
2.75 (9)	1 x 7'-2"	2 x 4'-10"	3 x 3'-7"	1 x 9'-7"	2 x 6'-0"	3 x 4'-10"
3.05 (10)	1 x 7'-7"	2 x 5'-2"	3 x 4'-0"	1 x 10'-5"	2 x 6'-10"	3 x 5'-2"
3.66 (12)	1 x 8'-0"	2 x 5'-7"	3 x 4'-0"	1 x 10'-5"	2 x 7'-2"	3 x 5'-7"
4.27 (14)	1 x 8'-0"	2 x 5'-7"	3 x 4'-0"	1 x 10'-5"	2 x 7'-2"	3 x 5'-7"
4.88 (16)	1 x 8'-0"	2 x 5'-7"	3 x 4'-0"	1 x 10'-5"	2 x 7'-2"	3 x 5'-7"
Vertical Reinforcement	ICF with 6" Tie Spacing			As per table A.1.1.		As per table A.1.1.
	ICF with 8" Tie Spacing			As per table A.1.2.		As per table A.1.2.
Horizontal Reinforcement	Block Height of 12" and 18"			10 M @ 450 (18)		10 M @ 450 (18)
	Block Height of 16"			10 M @ 400 (16)		10 M @ 400 (16)

**NOTES:**

1.  $S_{a,ICF}$  is equivalent spectral response acceleration for ICF walls as provided in Appendix A.
2. This table is to be used in conjunction with the "Design Limitations."
3. Provide two layers of the indicated horizontal and vertical distributed steel specified for 300mm (12") walls. Place each layer as shown in the rebar placement drawing.
4. All four sides of the building are to have a minimum number and length of shear walls that conforms to this table.
5. Use Table A.6 for buildings that do not meet the required wall length of this table.
6. Provide 2-15M concentrated reinforcement at each end of shear walls as shown in shear wall detail.
7. All concentrated reinforcement is to be continues to the bottom of the foundation wall. Provide lap splices as required.
8. Concentrated reinforcement is to be placed in accordance with Bar Placement Detail.

INSULATING CONCRETE FORMS MANUFACTURERS ASSOCIATION



**Table A.5.1600. Above Grade Shear Wall Length for Seismic Zone Classification,  $S_{a,ICF} \leq 0.16$  and Hourly Wind Pressure,  $0.5kPa < q_{1/50} \leq 0.75kPa$  (in a Building Without Walkout Basement), where Building Area  $\leq 1600ft^2$**

Wall Height m (ft)	Seismic Zone Classification					
	$S_{a,ICF} \leq 0.07$		$S_{a,ICF} \leq 0.11$		$S_{a,ICF} \leq 0.16$	
<b>Second Floor Walls of Two Story ICF Structure Supporting Wood Frame Roof (TYPE A)</b>						
	6" & 8" Thick Wall		10" & 12" Thick Wall		6" & 8" Thick Wall	
	Number and length of shear walls provided					
2.44 (8)	1 x 6'-5"	2 x 3'-2"	3 x 2'-8"	1 x 6'-5"	2 x 3'-2"	3 x 2'-8"
2.75 (9)	1 x 6'-5"	2 x 3'-2"	3 x 2'-8"	1 x 6'-5"	2 x 3'-2"	3 x 2'-8"
3.05 (10)	1 x 6'-5"	2 x 3'-2"	3 x 2'-8"	1 x 6'-5"	2 x 3'-2"	3 x 2'-8"
<b>Main Floor Walls of One Story ICF Structure Supporting Wood Frame Roof (TYPE B)</b>						
	6" & 8" Thick Wall		10" & 12" Thick Wall		6" & 8" Thick Wall	
	Number and length of shear walls provided					
2.44 (8)	1 x 6'-5"	2 x 3'-2"	3 x 2'-8"	1 x 6'-5"	2 x 3'-2"	3 x 2'-8"
2.75 (9)	1 x 6'-5"	2 x 3'-2"	3 x 2'-8"	1 x 6'-5"	2 x 3'-2"	3 x 2'-8"
3.05 (10)	1 x 6'-5"	2 x 3'-2"	3 x 2'-8"	1 x 6'-5"	2 x 3'-2"	3 x 2'-8"
3.66 (12)	1 x 6'-5"	2 x 3'-2"	3 x 2'-8"	1 x 6'-5"	2 x 3'-2"	3 x 2'-8"
4.27 (14)	1 x 6'-5"	2 x 3'-2"	3 x 2'-8"	1 x 6'-5"	2 x 3'-2"	3 x 2'-8"
4.88 (16)	1 x 6'-5"	2 x 3'-2"	3 x 2'-8"	1 x 6'-5"	2 x 3'-2"	3 x 2'-8"
<b>Main Floor Walls of Two Story Structure Supporting 2nd Story Wood Framed Walls, Floor and Roof (TYPE C)</b>						
	6" & 8" Thick Wall		10" & 12" Thick Wall		6" & 8" Thick Wall	
	Number and length of shear walls provided					
2.44 (8)	1 x 6'-5"	2 x 3'-9"	3 x 3'-0"	1 x 6'-5"	2 x 3'-2"	3 x 3'-0"
2.75 (9)	1 x 6'-5"	2 x 4'-0"	3 x 3'-0"	1 x 6'-5"	2 x 4'-3"	3 x 3'-2"
3.05 (10)	1 x 6'-5"	2 x 4'-3"	3 x 3'-2"	1 x 6'-5"	2 x 4'-0"	3 x 3'-2"
3.66 (12)	1 x 6'-10"	2 x 4'-5"	3 x 3'-2"	1 x 6'-10"	2 x 4'-5"	3 x 3'-2"
4.27 (14)	1 x 6'-10"	2 x 4'-5"	3 x 3'-7"	1 x 6'-10"	2 x 4'-10"	3 x 3'-7"
4.88 (16)	1 x 6'-10"	2 x 4'-5"	3 x 3'-7"	1 x 6'-10"	2 x 4'-10"	3 x 3'-7"
<b>Main Floor Walls of Two Story ICF Structure Supporting Wood Frame Floors and Roof (TYPE D)</b>						
	6" & 8" Thick Wall		10" & 12" Thick Wall		6" & 8" Thick Wall	
	Number and length of shear walls provided					
2.44 (8)	1 x 7'-2"	2 x 4'-5"	3 x 3'-7"	1 x 7'-2"	2 x 4'-5"	3 x 3'-7"
2.75 (9)	1 x 7'-2"	2 x 4'-10"	3 x 3'-7"	1 x 7'-2"	2 x 5'-2"	3 x 4'-0"
3.05 (10)	1 x 7'-7"	2 x 5'-2"	3 x 4'-0"	1 x 8'-0"	2 x 5'-2"	3 x 4'-0"
3.66 (12)	1 x 8'-0"	2 x 5'-7"	3 x 4'-0"	1 x 8'-0"	2 x 5'-7"	3 x 4'-0"
4.27 (14)	1 x 8'-0"	2 x 5'-7"	3 x 4'-5"	1 x 8'-5"	2 x 6'-8"	3 x 5'-2"
4.88 (16)	1 x 8'-0"	2 x 5'-7"	3 x 4'-5"	1 x 8'-5"	2 x 6'-8"	3 x 5'-2"
Vertical Reinforcement	ICF with 6" Tie Spacing	As per table A.1.1.		As per table A.1.1.		As per table A.1.1.
	ICF with 8" Tie Spacing	As per table A.1.2.		As per table A.1.2.		As per table A.1.2.
Horizontal Reinforcement	Block Height of 12" and 18"	10 M @ 450 (18)		10 M @ 450 (18)		10 M @ 450 (18)
	Block Height of 16"	10 M @ 400 (16)		10 M @ 400 (16)		10 M @ 400 (16)

**NOTES:**

1.  $S_{a,ICF}$  is equivalent spectral response acceleration for ICF walls as provided in Appendix A.
2. This table is to be used in conjunction with the "Design Limitations."
3. Provide two layers of the indicated horizontal and vertical distributed steel specified for 300mm (12") walls. Place each layer as shown in the rebar placement drawing.
4. All four sides of the building are to have a minimum number and length of shear walls that conforms to this table.
5. Use Table A.6 for buildings that do not meet the required wall length of this table.
6. Provide 2-15M concentrated reinforcement at each end of shear walls as shown in shear wall detail.
7. All concentrated reinforcement is to be continues to the bottom of the foundation wall. Provide lap splices as required.
8. Concentrated reinforcement is to be placed in accordance with Bar Placement Detail.

**INSULATING CONCRETE FORMS MANUFACTURERS ASSOCIATION**

**Table A.6.1600. Above Grade Shear Wall Length for Seismic Zone Classification,  $S_{a,ICF} > 0.16$  and Hourly Wind Pressure,  $q_{1/50} \leq 1.05\text{kPa}$  (in a Building Without Walkout Basement), where Building Area  $\leq 1600\text{ft}^2$**

Wall Height m (ft)	Seismic Zone Classification																																			
	$S_{a,ICF} \leq 0.16$			$S_{a,ICF} \leq 0.31$			$S_{a,ICF} \leq 0.53$			$S_{a,ICF} \leq 0.79$																										
<b>Second Floor Walls of Two Story ICF Structure Supporting Wood Frame Roof (TYPE A)</b>																																				
	6" & 8" Thick Wall		10" & 12" Thick Wall		6" & 8" Thick Wall		10" & 12" Thick Wall		6" & 8" Thick Wall		10" & 12" Thick Wall																									
	Number and length of shear walls provided																																			
2.44 (8)	1x 6'-5"	2x 3'-2"	3x 2'-8"	1x 6'-5"	2x 3'-2"	3x 2'-8"	1x 7'-2"	2x 4'-0"	3x 4'-0"	1x 7'-2"	2x 4'-0"	3x 4'-0"	1x 8'-0"	2x 6'-0"	3x 4'-0"	1x 9'-2"	2x 6'-5"	3x 5'-1"	1x 10'-0"	2x 6'-10"	3x 5'-7"	1x 10'-0"	2x 7'-2"	3x 5'-7"	1x 10'-10"	2x 7'-7"	3x 6'-0"	1x 11'-2"	2x 8'-5"	3x 6'-10"	1x 11'-2"	2x 8'-0"	3x 6'-5"	1x 11'-2"	2x 8'-0"	3x 6'-5"
2.75 (9)	1x 6'-5"	2x 3'-2"	3x 2'-10"	1x 6'-5"	2x 3'-2"	3x 2'-10"	1x 8'-0"	2x 5'-7"	3x 4'-6"	1x 8'-0"	2x 5'-7"	3x 4'-6"	1x 8'-0"	2x 6'-10"	3x 5'-7"	1x 10'-0"	2x 6'-10"	3x 5'-7"	1x 10'-0"	2x 7'-2"	3x 5'-7"	1x 10'-0"	2x 7'-2"	3x 5'-7"	1x 10'-10"	2x 7'-7"	3x 6'-0"	1x 11'-2"	2x 8'-5"	3x 6'-10"	1x 11'-2"	2x 8'-0"	3x 6'-5"	1x 11'-2"	2x 8'-0"	3x 6'-5"
3.05 (10)	1x 6'-5"	2x 3'-2"	3x 2'-2"	1x 6'-5"	2x 3'-2"	3x 2'-2"	1x 8'-0"	2x 5'-7"	3x 4'-6"	1x 8'-0"	2x 5'-7"	3x 4'-6"	1x 8'-0"	2x 6'-10"	3x 5'-7"	1x 10'-0"	2x 6'-10"	3x 5'-7"	1x 10'-0"	2x 7'-2"	3x 5'-7"	1x 10'-0"	2x 7'-2"	3x 5'-7"	1x 10'-10"	2x 7'-7"	3x 6'-0"	1x 11'-2"	2x 8'-5"	3x 6'-10"	1x 11'-2"	2x 8'-0"	3x 6'-5"	1x 11'-2"	2x 8'-0"	3x 6'-5"
3.66 (12)	1x 6'-5"	2x 3'-2"	3x 3'-6"	1x 6'-5"	2x 3'-2"	3x 3'-6"	1x 7'-2"	2x 4'-0"	3x 4'-0"	1x 7'-2"	2x 4'-0"	3x 4'-0"	1x 8'-0"	2x 6'-10"	3x 5'-7"	1x 10'-0"	2x 6'-10"	3x 5'-7"	1x 10'-0"	2x 7'-2"	3x 5'-7"	1x 10'-0"	2x 7'-2"	3x 5'-7"	1x 10'-10"	2x 7'-7"	3x 6'-0"	1x 11'-2"	2x 8'-5"	3x 6'-10"	1x 11'-2"	2x 8'-0"	3x 6'-5"	1x 11'-2"	2x 8'-0"	3x 6'-5"
4.27 (14)	1x 7'-2"	2x 5'-1"	3x 4'-0"	1x 7'-2"	2x 5'-1"	3x 4'-0"	1x 10'-5"	2x 7'-2"	3x 7'-0"	1x 10'-5"	2x 7'-2"	3x 7'-0"	1x 10'-5"	2x 7'-2"	3x 7'-0"	1x 14'-0"	2x 9'-7"	3x 7'-7"	1x 14'-0"	2x 9'-7"	3x 7'-7"	1x 14'-0"	2x 9'-7"	3x 7'-7"	1x 14'-5"	2x 10'-0"	3x 8'-0"	1x 15'-4"	2x 10'-10"	3x 8'-10"	1x 16'-4"	2x 11'-2"	3x 10'-0"	1x 16'-4"	2x 11'-2"	3x 10'-0"
4.88 (16)	1x 7'-2"	2x 5'-2"	3x 4'-4"	1x 8'-6"	2x 5'-10"	3x 4'-6"	1x 10'-10"	2x 8'-0"	3x 7'-0"	1x 12'-4"	2x 8'-5"	3x 8'-0"	1x 15'-2"	2x 10'-0"	3x 8'-0"	1x 16'-6"	2x 11'-6"	3x 9'-2"	1x 16'-6"	2x 11'-6"	3x 9'-2"	1x 16'-6"	2x 11'-6"	3x 9'-2"	1x 17'-7"	2x 12'-0"	3x 10'-0"	1x 18'-6"	2x 12'-10"	3x 10'-5"	1x 18'-6"	2x 12'-10"	3x 10'-5"	1x 18'-6"	2x 12'-10"	3x 10'-5"
<b>Main Floor Walls of One Story ICF Structure Supporting Wood Frame Roof (TYPE B)</b>																																				
	6" & 8" Thick Wall		10" & 12" Thick Wall		6" & 8" Thick Wall		10" & 12" Thick Wall		6" & 8" Thick Wall		10" & 12" Thick Wall																									
	Number and length of shear walls provided																																			
2.44 (8)	1x 6'-5"	2x 3'-2"	3x 2'-8"	1x 6'-5"	2x 3'-2"	3x 2'-8"	1x 7'-2"	2x 4'-0"	3x 4'-0"	1x 7'-2"	2x 4'-0"	3x 4'-0"	1x 8'-0"	2x 5'-7"	3x 4'-5"	1x 8'-5"	2x 5'-7"	3x 4'-5"	1x 8'-10"	2x 6'-5"	3x 5'-2"	1x 9'-0"	2x 6'-5"	3x 5'-2"	1x 8'-10"	2x 6'-5"	3x 5'-2"	1x 9'-7"	2x 6'-5"	3x 5'-2"	1x 9'-7"	2x 6'-5"	3x 5'-2"	1x 9'-7"	2x 6'-5"	3x 5'-2"
2.75 (9)	1x 6'-5"	2x 3'-2"	3x 2'-8"	1x 6'-5"	2x 3'-2"	3x 2'-8"	1x 7'-2"	2x 4'-0"	3x 4'-0"	1x 7'-2"	2x 4'-0"	3x 4'-0"	1x 8'-0"	2x 5'-7"	3x 4'-5"	1x 8'-5"	2x 5'-7"	3x 4'-5"	1x 8'-10"	2x 6'-5"	3x 5'-2"	1x 9'-0"	2x 6'-5"	3x 5'-2"	1x 8'-10"	2x 6'-5"	3x 5'-2"	1x 9'-7"	2x 6'-5"	3x 5'-2"	1x 9'-7"	2x 6'-5"	3x 5'-2"	1x 9'-7"	2x 6'-5"	3x 5'-2"
3.05 (10)	1x 6'-5"	2x 3'-2"	3x 2'-10"	1x 6'-5"	2x 3'-2"	3x 2'-10"	1x 8'-0"	2x 5'-7"	3x 4'-6"	1x 8'-0"	2x 5'-7"	3x 4'-6"	1x 8'-0"	2x 6'-10"	3x 5'-7"	1x 10'-0"	2x 6'-10"	3x 5'-7"	1x 10'-0"	2x 7'-2"	3x 5'-7"	1x 10'-0"	2x 7'-2"	3x 5'-7"	1x 10'-10"	2x 7'-7"	3x 6'-0"	1x 11'-2"	2x 8'-5"	3x 6'-10"	1x 11'-2"	2x 8'-0"	3x 6'-5"	1x 11'-2"	2x 8'-0"	3x 6'-5"
3.66 (12)	1x 6'-5"	2x 3'-2"	3x 3'-6"	1x 6'-5"	2x 3'-2"	3x 3'-6"	1x 7'-2"	2x 4'-0"	3x 4'-0"	1x 7'-2"	2x 4'-0"	3x 4'-0"	1x 8'-0"	2x 6'-10"	3x 5'-7"	1x 10'-0"	2x 6'-10"	3x 5'-7"	1x 10'-0"	2x 7'-2"	3x 5'-7"	1x 10'-0"	2x 7'-2"	3x 5'-7"	1x 10'-10"	2x 7'-7"	3x 6'-0"	1x 11'-2"	2x 8'-5"	3x 6'-10"	1x 11'-2"	2x 8'-0"	3x 6'-5"	1x 11'-2"	2x 8'-0"	3x 6'-5"
4.27 (14)	1x 7'-2"	2x 5'-1"	3x 4'-0"	1x 7'-2"	2x 5'-1"	3x 4'-0"	1x 10'-5"	2x 7'-2"	3x 7'-0"	1x 10'-5"	2x 7'-2"	3x 7'-0"	1x 10'-5"	2x 7'-2"	3x 7'-0"	1x 14'-0"	2x 9'-7"	3x 7'-7"	1x 14'-0"	2x 9'-7"	3x 7'-7"	1x 14'-0"	2x 9'-7"	3x 7'-7"	1x 14'-5"	2x 10'-0"	3x 8'-0"	1x 15'-4"	2x 10'-10"	3x 8'-10"	1x 16'-4"	2x 11'-2"	3x 10'-0"	1x 16'-4"	2x 11'-2"	3x 10'-0"
4.88 (16)	1x 7'-2"	2x 5'-2"	3x 4'-4"	1x 8'-6"	2x 5'-10"	3x 4'-6"	1x 10'-10"	2x 8'-0"	3x 7'-0"	1x 12'-4"	2x 8'-5"	3x 8'-0"	1x 15'-2"	2x 10'-0"	3x 8'-0"	1x 16'-6"	2x 11'-6"	3x 9'-2"	1x 16'-6"	2x 11'-6"	3x 9'-2"	1x 16'-6"	2x 11'-6"	3x 9'-2"	1x 17'-7"	2x 12'-0"	3x 10'-0"	1x 18'-6"	2x 12'-10"	3x 10'-5"	1x 18'-6"	2x 12'-10"	3x 10'-5"	1x 18'-6"	2x 12'-10"	3x 10'-5"
<b>Main Floor Walls of Two Story Structure Supporting 2nd Story Wood Framed Walls, Floor and Roof (TYPE C)</b>																																				
	6" & 8" Thick Wall		10" & 12" Thick Wall		6" & 8" Thick Wall		10" & 12" Thick Wall		6" & 8" Thick Wall		10" & 12" Thick Wall																									
	Number and length of shear walls provided																																			
2.44 (8)	1x 8'-0"	2x 5'-2"	3x 4'-0"	1x 8'-0"	2x 5'-2"	3x 4'-0"	1x 11'-2"	2x 7'-7"	3x 6'-0"	1x 11'-2"	2x 7'-7"	3x 6'-0"	1x 15'-2"	2x 10'-5"	3x 8'-10"	1x 15'-2"	2x 10'-5"	3x 8'-10"	1x 16'-0"	2x 11'-2"	3x 9'-7"	1x 16'-0"	2x 11'-2"	3x 9'-7"	1x 16'-0"	2x 11'-2"	3x 9'-7"	1x 16'-0"	2x 11'-2"	3x 9'-7"	1x 16'-0"	2x 11'-2"	3x 9'-7"	1x 16'-0"	2x 11'-2"	3x 9'-7"
2.75 (9)	1x 8'-0"	2x 5'-7"	3x 4'-10"	1x 8'-0"	2x 5'-7"	3x 4'-10"	1x 12'-0"	2x 8'-0"	3x 6'-5"	1x 12'-0"	2x 8'-0"	3x 6'-5"	1x 16'-5"	2x 11'-2"	3x 8'-10"	1x 16'-5"	2x 11'-2"	3x 8'-10"	1x 16'-0"	2x 11'-2"	3x 9'-7"	1x 16'-0"	2x 11'-2"	3x 9'-7"	1x 16'-0"	2x 11'-2"	3x 9'-7"	1x 16'-0"	2x 11'-2"	3x 9'-7"	1x 16'-0"	2x 11'-2"	3x 9'-7"	1x 16'-0"	2x 11'-2"	3x 9'-7"
3.05 (10)	1x 8'-0"	2x 5'-7"	3x 4'-10"	1x 8'-0"	2x 5'-7"	3x 4'-10"	1x 12'-0"	2x 8'-0"	3x 6'-5"	1x 12'-0"	2x 8'-0"	3x 6'-5"	1x 13'-7"	2x 8'-10"	3x 6'-10"	1x 13'-7"	2x 8'-10"	3x 6'-10"	1x 13'-7"	2x 8'-10"	3x 6'-10"	1x 13'-7"	2x 8'-10"	3x 6'-10"	1x 13'-7"	2x 8'-10"	3x 6'-10"	1x 13'-7"	2x 8'-10"	3x 6'-10"	1x 13'-7"	2x 8'-10"	3x 6'-10"	1x 13'-7"	2x 8'-10"	3x 6'-10"
3.66 (12)	1x 9'-2"	2x 6'-5"	3x 5'-2"	1x 10'-5"	2x 7'-2"	3x 5'-7"	1x 12'-10"	2x 9'-2"	3x 7'-2"	1x 12'-10"	2x 9'-2"	3x 7'-2"	1x 14'-10"	2x 10'-0"	3x 8'-0"	1x 14'-10"	2x 10'-0"	3x 8'-0"	1x 17'-2"	2x 12'-0"	3x 9'-7"	1x 17'-2"	2x 12'-0"	3x 9'-7"	1x 17'-2"	2x 12'-0"	3x 9'-7"	1x 17'-2"	2x 12'-0"	3x 9'-7"	1x 17'-2"	2x 12'-0"	3x 9'-7"	1x 17'-2"	2x 12'-0"	3x 9'-7"
4.27 (14)	1x 10'-0"	2x 6'-10"	3x 5'-7"	1x 10'-5"	2x 7'-2"	3x 5'-7"	1x 14'-0"	2x 9'-7"	3x 8'-0"	1x 14'-10"	2x 10'-0"	3x 8'-0"	1x 19'-2"	2x 13'-2"	3x 10'-5"	1x 19'-2"	2x 13'-2"	3x 10'-5"	1x 19'-2"	2x 13'-2"	3x 10'-5"	1x 19'-2"	2x 13'-2"	3x 10'-5"	1x 20'-10"	2x 14'-5"	3x 12'-0"	1x 20'-10"	2x 14'-5"	3x 12'-0"	1x 20'-10"	2x 14'-5"	3x 12'-0"	1x 20'-10"	2x 14'-5"	3x 12'-0"
4.88 (16)	1x 10'-0"	2x 6'-10"	3x 5'-7"	1x 10'-5"	2x 7'-2"	3x 5'-7"	1x 14'-0"	2x 9'-7"	3x 8'-0"	1x 14'-10"	2x 10'-0"	3x 8'-0"	1x 19'-2"	2x 13'-2"	3x 10'-5"	1x 19'-2"	2x 13'-2"	3x 10'-5"	1x 20'-10"	2x 14'-5"	3x 12'-0"	1x 20'-10"	2x 14'-5"	3x 12'-0"	1x 20'-10"	2x 14'-5"	3x 12'-0"	1x 20'-10"	2x 14'-5"	3x 12'-0"	1x 20'-10"	2x 14'-5"	3x 12'-0"	1x 20'-10"	2x 14'-5"	3x 12'-0"
<b>Main Floor Walls of Two Story ICF Structure Supporting Wood Frame Floors and Roof (TYPE D)</b>																																				
	6" & 8" Thick Wall		10" & 12" Thick Wall		6" & 8" Thick Wall		10" & 12" Thick Wall		6" & 8" Thick Wall		10" & 12" Thick Wall																									
	Number and length of shear walls provided																																			
2.44 (8)	1x 9'-7"	2x 6'-5"	3x 5'-2"	1x 10'-0"	2x 6'-10"	3x 5'-2"	1x 13'-7"	2x 9'-7"	3x 7'-2"	1x 14'-5"	2x 9'-7"	3x 7'-2"	1x 16'-10"	2x 12'-0"	3x 9'-7"	1x 17'-7"	2x 12'-0"	3x 9'-7"	1x 18'-5"	2x 12'-10"	3x 11'-2"	1x 19'-4"	2x 13'-7"	3x 11'-2"	1x 19'-4"	2x 13'-7"	3x 11'-2"	1x 19'-4"	2x 13'-7"	3x 11'-2"	1x 19'-4"	2x 13'-7"	3x 11'-2"	1x 19'-4"	2x 13'-7"	3x 11'-2"
2.75 (9)	1x 10'-5"	2x 7'-2"	3x 5'-7"	1x 10'-5"	2x 7'-2"	3x 5'-7"	1x 14'-5"	2x 10'-5"	3x 8'-0"	1x 16'-0"	2x 10'-5"	3x 8'-0"	1x 17'-7"	2x 12'-4"	3x 10'-5"	1x 18'-5"	2x 12'-10"	3x 10'-5"	1x 18'-5"	2x 12'-10"	3x 10'-5"	1x 18'-5"	2x 12'-10"	3x 10'-5"	1x 18'-5"	2x 12'-10"	3x 10'-5"	1x 18'-5"	2x 12'-10"	3x 10'-5"	1x 18'-5"	2x 12'-10"	3x 10'-5"	1x 18'-5"	2x 12'-10"	3x 10'-5"
3.05 (10)	1x 11'-2"	2x 7'-2"	3x 5'-7"	1x 11'-2"	2x 8'-0"	3x 6'-0"	1x 15'-2"	2x 10'-5"	3x 8'-10"	1x 16'-0"	2x 11'-2"	3x 8'-10"	1x 18'-5"	2x 12'-10"	3x 10'-5"	1x 19'-2"	2x 13'-7"	3x 11'-2"	1x 20'-10"	2x 14'-5"	3x 12'-0"	1x 21'-7"	2x 15'-2"	3x 12'-0"	1x 21'-7"	2x 15'-2"	3x 12'-0"	1x 21'-7"	2x 15'-2"	3x 12'-0"	1x 21'-7"	2x 15'-2"	3x 12'-0"	1x 21'-7"	2x 15'-2"	3x 12'-0"
3.66 (12)	1x 11'-2"	2x 7'-7"	3x 6'-0"	1x 12'-10"	2x 8'-10"	3x 7'-0"	1x 16'-0"	2x 10'-6"	3x 8'-10"	1x 18'-5"	2x 12'-10"	3x 10'-0"	1x 20'-4"	2x 14'-5"	3x 11'-4"	1x 21'-0"	2x 14'-8"	3x 12'-0"	1x 22'-6"	2x 16'-0"	3x 12'-10"	1x 24'-10"	2x 16'-6"	3x 13'-7"	1x 22'-6"	2x 16'-0"	3x 12'-10"	1x 24'-10"	2x 16'-6"	3x 13'-7"	1x 22'-6"	2x 16'-0"	3x 12'-10"	1x 24'-10"	2x 16'-6"	3x 13'-7"
4.27 (14)	1x 12'-0"	2x 8'-4"	3x 6'-5"	1x 12'-10"	2x 8'-10"	3x 7'-0"	1x 16'-10"	2x 12'-0"	3x 9'-7"	1x 18'-5"	2x 12'-10"	3x 10'-0"	1x 22'-5"	2x 15'-6"	3x 12'-5"	1x 23'-0"	2x 16'-0"	3x 12'-10"	1x 23'-0"	2x 16'-0"	3x 12'-10"	1x 24'-10"	2x 16'-6"	3x 13'-7"	1x 23'-0"	2x 16'-0"	3x 12'-10"	1x 24'-10"	2x 16'-6"	3x 13'-7"	1x 23'-0"	2x 16'-0"	3x 12'-10"	1x 23'-0"	2x 16'-0"	3x 12'-10"
4.88 (16)	1x 12'-0"	2x 8'-4"	3x 6'-5"	1x 13'-7"	2x 9'-0"	3x 7'-2"	1x 16'-10"	2x 12'-0"	3x 9'-7"	1x 18'-5"	2x 12'-10"	3x 10'-0"	1x 22'-5"	2x 15'-6"	3x 12'-5"	1x 23'-0"	2x 16'-0"	3x 12'-10"	1x 23'-0"	2x 16'-0"	3x 12'-10"	1x 24'-10"	2x 16'-6"	3x 13'-7"	1x 23'-0"	2x 16										

**Table A.7.1600. Above Grade Shear Wall Length for Seismic Zone Classification,  $S_{a,ICF} \leq 0.16$  and Hourly Wind Pressure,  $q_{1/50} \leq 0.5kPa$  (in a Building With Walk Basement), where Building Area  $\leq 1600ft^2$**

Wall Height m (ft)	Seismic Zone Classification					
	$S_{a,ICF} \leq 0.07$		$S_{a,ICF} \leq 0.11$		$S_{a,ICF} \leq 0.16$	
<b>Second Floor Walls of Two Story ICF Structure Supporting Wood Frame Roof (TYPE E)</b>						
	6" & 8" Thick Wall		10" & 12" Thick Wall		6" & 8" Thick Wall	
	Number and length of shear walls provided					
2.44 (8)	1 x 6'-5"	2 x 3'-2" 3 x 2'-8"	1 x 6'-5"	2 x 3'-2" 3 x 2'-8"	1 x 6'-5"	2 x 3'-2" 3 x 2'-8"
2.75 (9)	1 x 6'-5"	2 x 3'-2" 3 x 2'-8"	1 x 6'-5"	2 x 3'-2" 3 x 2'-8"	1 x 6'-5"	2 x 3'-2" 3 x 2'-8"
3.05 (10)	1 x 6'-5"	2 x 3'-2" 3 x 2'-8"	1 x 6'-5"	2 x 3'-2" 3 x 2'-8"	1 x 6'-5"	2 x 3'-2" 3 x 2'-8"
3.66 (12)	1 x 6'-5"	2 x 3'-2" 3 x 2'-8"	1 x 6'-5"	2 x 3'-2" 3 x 2'-8"	1 x 6'-5"	2 x 3'-2" 3 x 2'-8"
4.27 (14)	1 x 6'-5"	2 x 3'-2" 3 x 2'-8"	1 x 6'-5"	2 x 3'-2" 3 x 2'-8"	1 x 6'-5"	2 x 3'-2" 3 x 2'-8"
4.88 (16)	1 x 6'-5"	2 x 3'-2" 3 x 2'-8"	1 x 6'-5"	2 x 3'-2" 3 x 2'-8"	1 x 6'-5"	2 x 3'-2" 3 x 2'-8"
<b>Main Floor Walls of One Story ICF Structure Supporting Wood Frame Roof (TYPE F)</b>						
	6" & 8" Thick Wall		10" & 12" Thick Wall		6" & 8" Thick Wall	
	Number and length of shear walls provided					
2.44 (8)	1 x 6'-5"	2 x 3'-2" 3 x 2'-8"	1 x 6'-5"	2 x 3'-2" 3 x 2'-8"	1 x 6'-5"	2 x 3'-2" 3 x 2'-8"
2.75 (9)	1 x 6'-5"	2 x 3'-2" 3 x 2'-8"	1 x 6'-5"	2 x 3'-2" 3 x 2'-8"	1 x 6'-5"	2 x 3'-2" 3 x 2'-8"
3.05 (10)	1 x 6'-5"	2 x 3'-2" 3 x 2'-8"	1 x 6'-5"	2 x 3'-2" 3 x 2'-8"	1 x 6'-5"	2 x 3'-2" 3 x 2'-8"
3.66 (12)	1 x 6'-5"	2 x 3'-2" 3 x 2'-8"	1 x 6'-5"	2 x 3'-2" 3 x 2'-8"	1 x 6'-5"	2 x 3'-2" 3 x 2'-8"
4.27 (14)	1 x 6'-5"	2 x 3'-2" 3 x 2'-8"	1 x 6'-5"	2 x 3'-2" 3 x 2'-8"	1 x 6'-5"	2 x 3'-2" 3 x 2'-8"
4.88 (16)	1 x 6'-5"	2 x 3'-2" 3 x 2'-8"	1 x 6'-5"	2 x 3'-2" 3 x 2'-8"	1 x 6'-5"	2 x 3'-2" 3 x 2'-8"
<b>Main Floor Walls of Two Story Structure Supporting 2nd Story Wood Framed Walls, Floor and Roof (TYPE G)</b>						
	6" & 8" Thick Wall		10" & 12" Thick Wall		6" & 8" Thick Wall	
	Number and length of shear walls provided					
2.44 (8)	1 x 6'-5"	2 x 4'-0" 3 x 3'-2"	1 x 6'-5"	2 x 4'-0" 3 x 3'-2"	1 x 6'-5"	2 x 4'-0" 3 x 3'-2"
2.75 (9)	1 x 6'-5"	2 x 4'-0" 3 x 3'-2"	1 x 6'-5"	2 x 4'-0" 3 x 3'-2"	1 x 6'-5"	2 x 4'-0" 3 x 3'-2"
3.05 (10)	1 x 6'-5"	2 x 4'-0" 3 x 3'-2"	1 x 6'-5"	2 x 4'-0" 3 x 3'-2"	1 x 6'-5"	2 x 4'-0" 3 x 3'-2"
3.66 (12)	1 x 6'-5"	2 x 4'-0" 3 x 3'-2"	1 x 6'-5"	2 x 4'-0" 3 x 3'-2"	1 x 6'-5"	2 x 4'-0" 3 x 3'-2"
4.27 (14)	1 x 6'-5"	2 x 4'-0" 3 x 3'-2"	1 x 6'-5"	2 x 4'-0" 3 x 3'-2"	1 x 6'-5"	2 x 4'-0" 3 x 3'-2"
4.88 (16)	1 x 6'-5"	2 x 4'-0" 3 x 3'-2"	1 x 6'-5"	2 x 4'-0" 3 x 3'-2"	1 x 6'-5"	2 x 4'-0" 3 x 3'-2"
<b>Main Floor Walls of Two Story ICF Structure Supporting Wood Frame Floors and Roof (TYPE H)</b>						
	6" & 8" Thick Wall		10" & 12" Thick Wall		6" & 8" Thick Wall	
	Number and length of shear walls provided					
2.44 (8)	1 x 7'-6"	2 x 4'-10" 3 x 3'-7"	1 x 8'-0"	2 x 5'-1" 3 x 4'-0"	1 x 8'-0"	2 x 5'-1" 3 x 4'-0"
2.75 (9)	1 x 7'-6"	2 x 4'-10" 3 x 3'-7"	1 x 8'-0"	2 x 5'-1" 3 x 4'-0"	1 x 8'-0"	2 x 5'-1" 3 x 4'-0"
3.05 (10)	1 x 7'-6"	2 x 4'-10" 3 x 3'-7"	1 x 8'-0"	2 x 5'-1" 3 x 4'-0"	1 x 8'-0"	2 x 5'-1" 3 x 4'-0"
3.66 (12)	1 x 7'-6"	2 x 4'-10" 3 x 3'-7"	1 x 8'-0"	2 x 5'-1" 3 x 4'-0"	1 x 8'-0"	2 x 5'-1" 3 x 4'-0"
4.27 (14)	1 x 7'-6"	2 x 4'-10" 3 x 3'-7"	1 x 8'-0"	2 x 5'-1" 3 x 4'-0"	1 x 8'-0"	2 x 5'-1" 3 x 4'-0"
4.88 (16)	1 x 7'-6"	2 x 4'-10" 3 x 3'-7"	1 x 8'-0"	2 x 5'-1" 3 x 4'-0"	1 x 8'-0"	2 x 5'-1" 3 x 4'-0"
Vertical Reinforcement	ICF with 6" Tie Spacing	As per table A.1.1.		As per table A.1.1.		As per table A.1.1.
Vertical Reinforcement	ICF with 8" Tie Spacing	As per table A.1.2.		As per table A.1.2.		As per table A.1.2.
Horizontal Reinforcement	Block Height of 12" and 18"	10 M @ 450 (18)		10 M @ 450 (18)		10 M @ 450 (18)
Horizontal Reinforcement	Block Height of 16"	10 M @ 400 (16)		10 M @ 400 (16)		10 M @ 400 (16)

**NOTES:**

1.  $S_{a,ICF}$  is equivalent spectral response acceleration for ICF walls as provided in Appendix A.
2. This table is to be used in conjunction with the "Design Limitations."
3. Provide two layers of the indicated horizontal and vertical distributed steel specified for 300mm (12") walls. Place each layer as shown in the rebar placement drawing.
4. All four sides of the building are to have a minimum number and length of shear walls that conforms to this table.
5. Use Table A.6 for buildings that do not meet the required wall length of this table.
6. Provide 2-15M concentrated reinforcement at each end of shear walls as shown in shear wall detail.
7. All concentrated reinforcement is to be continues to the bottom of the foundation wall. Provide lap splices as required.
8. Concentrated reinforcement is to be placed in accordance with Bar Placement Detail.

INSULATING CONCRETE FORMS MANUFACTURERS ASSOCIATION

**Table A.8.1600. Above Grade Shear Wall Length for Seismic Zone Classification,  $S_{a,ICF} \leq 0.16$  and Hourly Wind Pressure,  $0.5kPa < q1/50 \leq 0.75kPa$  (in a Building With Walkout Basement), where Building Area  $\leq 1600ft^2$**

Wall Height m (ft)	Seismic Zone Classification					
	$S_{a,ICF} \leq 0.07$		$S_{a,ICF} \leq 0.11$		$S_{a,ICF} \leq 0.16$	
<b>Second Floor Walls of Two Story ICF Structure Supporting Wood Frame Roof (TYPE E)</b>						
	6" & 8" Thick Wall		10" & 12" Thick Wall		10" & 12" Thick Wall	
	Number and length of shear walls provided					
2.44 (8)	1 x 6'-5"	2 x 3'-2"	3 x 2'-8"	1 x 6'-5"	2 x 3'-2"	3 x 2'-8"
2.75 (9)	1 x 6'-5"	2 x 3'-2"	3 x 2'-8"	1 x 6'-5"	2 x 3'-2"	3 x 2'-8"
3.05 (10)	1 x 6'-5"	2 x 3'-2"	3 x 2'-8"	1 x 6'-5"	2 x 4'-0"	3 x 3'-2"
<b>Main Floor Walls of One Story ICF Structure Supporting Wood Frame Roof (TYPE F)</b>						
	6" & 8" Thick Wall		10" & 12" Thick Wall		10" & 12" Thick Wall	
	Number and length of shear walls provided					
2.44 (8)	1 x 6'-5"	2 x 3'-2"	3 x 2'-8"	1 x 6'-5"	2 x 3'-2"	3 x 2'-8"
2.75 (9)	1 x 6'-5"	2 x 3'-2"	3 x 2'-8"	1 x 6'-5"	2 x 3'-2"	3 x 2'-8"
3.05 (10)	1 x 6'-5"	2 x 3'-2"	3 x 2'-8"	1 x 6'-5"	2 x 3'-7"	3 x 2'-10"
3.66 (12)	1 x 6'-5"	2 x 3'-2"	3 x 2'-8"	1 x 6'-5"	2 x 3'-6"	3 x 3'-6"
4.27 (14)	1 x 6'-5"	2 x 3'-7"	3 x 3'-2"	1 x 6'-5"	2 x 4'-0"	3 x 3'-2"
4.88 (16)	1 x 6'-5"	2 x 4'-0"	3 x 3'-2"	1 x 7'-2"	2 x 4'-5"	3 x 3'-7"
<b>Main Floor Walls of Two Story Structure Supporting 2nd Story Wood Framed Walls, Floor and Roof (TYPE G)</b>						
	6" & 8" Thick Wall		10" & 12" Thick Wall		10" & 12" Thick Wall	
	Number and length of shear walls provided					
2.44 (8)	1 x 6'-5"	2 x 4'-0"	3 x 3'-2"	1 x 8'-3"	2 x 5'-4"	3 x 4'-3"
2.75 (9)	1 x 6'-5"	2 x 4'-0"	3 x 3'-2"	1 x 8'-5"	2 x 5'-4"	3 x 4'-0"
3.05 (10)	1 x 6'-11"	2 x 4'-6"	3 x 3'-6"	1 x 9'-2"	2 x 6'-0"	3 x 4'-10"
3.66 (12)	1 x 7'-6"	2 x 5'-1"	3 x 4'-0"	1 x 9'-10"	2 x 6'-8"	3 x 5'-2"
4.27 (14)	1 x 7'-9"	2 x 5'-2"	3 x 4'-3"	1 x 10'-2"	2 x 6'-10"	3 x 5'-7"
4.88 (16)	1 x 8'-0"	2 x 5'-7"	3 x 4'-5"	1 x 10'-5"	2 x 7'-2"	3 x 6'-0"
<b>Main Floor Walls of Two Story ICF Structure Supporting Wood Frame Floors and Roof (TYPE H)</b>						
	6" & 8" Thick Wall		10" & 12" Thick Wall		10" & 12" Thick Wall	
	Number and length of shear walls provided					
2.44 (8)	1 x 7'-6"	2 x 4'-10"	3 x 3'-9"	1 x 8'-0"	2 x 5'-1"	3 x 4'-0"
2.75 (9)	1 x 7'-9"	2 x 5'-2"	3 x 3'-9"	1 x 8'-10"	2 x 5'-2"	3 x 4'-0"
3.05 (10)	1 x 8'-10"	2 x 5'-7"	3 x 4'-5"	1 x 11'-2"	2 x 7'-7"	3 x 5'-10"
3.66 (12)	1 x 9'-2"	2 x 6'-0"	3 x 4'-10"	1 x 11'-7"	2 x 8'-0"	3 x 6'-2"
4.27 (14)	1 x 9'-2"	2 x 6'-5"	3 x 5'-2"	1 x 12'-0"	2 x 8'-0"	3 x 6'-5"
4.88 (16)	1 x 9'-2"	2 x 6'-5"	3 x 5'-2"	1 x 10'-5"	2 x 7'-2"	3 x 5'-7"
<b>Vertical Reinforcement</b>						
	ICF with 6" Tie Spacing	As per table A.1.1.		As per table A.1.1.		As per table A.1.1.
	ICF with 8" Tie Spacing	As per table A.1.2.		As per table A.1.2.		As per table A.1.2.
<b>Horizontal Reinforcement</b>						
	Block Height of 12" and 18"	10 M @ 450 (18)		10 M @ 450 (18)		10 M @ 450 (18)
	Block Height of 16"	10 M @ 400 (16)		10 M @ 400 (16)		10 M @ 400 (16)

**NOTES:**

1.  $S_{a,ICF}$  is equivalent spectral response acceleration for ICF walls as provided in Appendix A.
2. This table is to be used in conjunction with the "Design Limitations."
3. Provide two layers of the indicated horizontal and vertical distributed steel specified for 300mm (12") walls. Place each layer as shown in the rebar placement drawing.
4. All four sides of the building are to have a minimum number and length of shear walls that conforms to this table.
5. Use Table A.6 for buildings that do not meet the required wall length of this table.
6. Provide 2-15M concentrated reinforcement at each end of shear walls as shown in shear wall detail.
7. All concentrated reinforcement is to be continues to the bottom of the foundation wall. Provide lap splices as required.
8. Concentrated reinforcement is to be placed in accordance with Bar Placement Detail.

INSULATING CONCRETE FORMS MANUFACTURERS ASSOCIATION

**Table A.9.1600. Above Grade Shear Wall Length for Seismic Zone Classification,  $S_{a,ICF} \leq 0.16$  and Hourly Wind Pressure,  $0.75kPa < q_{1/50} \leq 1.05kPa$  (in a Building With Walkout Basement), where Building Area  $\leq 1600ft^2$**

Wall Height m (ft)	Seismic Zone Classification					
	$S_{a,ICF} \leq 0.07$		$S_{a,ICF} \leq 0.11$		$S_{a,ICF} \leq 0.16$	
<b>Second Floor Walls of Two Story ICF Structure Supporting Wood Frame Roof (TYPE E)</b>						
	6" & 8" Thick Wall		10" & 12" Thick Wall		6" & 8" Thick Wall	
	Number and length of shear walls provided					
2.44 (8)	1 x 6'-5"	2 x 3'-2"	3 x 2'-8"	1 x 6'-5"	2 x 3'-2"	3 x 2'-8"
2.75 (9)	1 x 6'-5"	2 x 3'-2"	3 x 2'-8"	1 x 6'-5"	2 x 3'-6"	3 x 2'-8"
3.05 (10)	1 x 6'-5"	2 x 3'-2"	3 x 2'-8"	1 x 6'-5"	2 x 4'-0"	3 x 3'-2"
<b>Main Floor Walls of One Story ICF Structure Supporting Wood Frame Roof (TYPE F)</b>						
	6" & 8" Thick Wall		10" & 12" Thick Wall		6" & 8" Thick Wall	
	Number and length of shear walls provided					
2.44 (8)	1 x 6'-5"	2 x 3'-2"	3 x 2'-8"	1 x 6'-5"	2 x 3'-2"	3 x 2'-8"
2.75 (9)	1 x 6'-5"	2 x 3'-2"	3 x 2'-8"	1 x 6'-5"	2 x 3'-2"	3 x 2'-8"
3.05 (10)	1 x 6'-5"	2 x 3'-2"	3 x 2'-8"	1 x 6'-5"	2 x 3'-7"	3 x 2'-10"
3.66 (12)	1 x 6'-5"	2 x 3'-2"	3 x 2'-8"	1 x 6'-5"	2 x 3'-6"	3 x 2'-8"
4.27 (14)	1 x 6'-5"	2 x 3'-7"	3 x 3'-2"	1 x 6'-5"	2 x 4'-0"	3 x 3'-2"
4.88 (16)	1 x 6'-5"	2 x 4'-0"	3 x 3'-2"	1 x 7'-2"	2 x 4'-5"	3 x 3'-7"
<b>Main Floor Walls of Two Story Structure Supporting 2nd Story Wood Framed Walls, Floor and Roof (TYPE G)</b>						
	6" & 8" Thick Wall		10" & 12" Thick Wall		6" & 8" Thick Wall	
	Number and length of shear walls provided					
2.44 (8)	1 x 6'-5"	2 x 4'-0"	3 x 3'-2"	1 x 6'-5"	2 x 4'-0"	3 x 3'-2"
2.75 (9)	1 x 6'-5"	2 x 4'-0"	3 x 3'-2"	1 x 6'-8"	2 x 4'-3"	3 x 3'-2"
3.05 (10)	1 x 6'-11"	2 x 4'-6"	3 x 3'-6"	1 x 6'-10"	2 x 4'-5"	3 x 3'-6"
3.66 (12)	1 x 7'-6"	2 x 5'-1"	3 x 4'-0"	1 x 7'-6"	2 x 5'-1"	3 x 4'-0"
4.27 (14)	1 x 7'-9"	2 x 5'-2"	3 x 4'-3"	1 x 8'-3"	2 x 5'-4"	3 x 4'-3"
4.88 (16)	1 x 8'-0"	2 x 5'-7"	3 x 4'-5"	1 x 8'-10"	2 x 5'-7"	3 x 4'-5"
<b>Main Floor Walls of Two Story ICF Structure Supporting Wood Frame Floors and Roof (TYPE H)</b>						
	6" & 8" Thick Wall		10" & 12" Thick Wall		6" & 8" Thick Wall	
	Number and length of shear walls provided					
2.44 (8)	1 x 7'-6"	2 x 4'-10"	3 x 3'-9"	1 x 8'-0"	2 x 5'-1"	3 x 4'-0"
2.75 (9)	1 x 7'-9"	2 x 5'-2"	3 x 3'-9"	1 x 8'-10"	2 x 5'-7"	3 x 4'-3"
3.05 (10)	1 x 8'-10"	2 x 5'-7"	3 x 4'-5"	1 x 8'-5"	2 x 5'-4"	3 x 4'-0"
3.66 (12)	1 x 9'-2"	2 x 6'-0"	3 x 4'-10"	1 x 9'-2"	2 x 6'-8"	3 x 5'-2"
4.27 (14)	1 x 9'-2"	2 x 6'-5"	3 x 5'-2"	1 x 9'-10"	2 x 6'-8"	3 x 5'-2"
4.88 (16)	1 x 9'-2"	2 x 6'-5"	3 x 5'-2"	1 x 10'-0"	2 x 6'-10"	3 x 5'-7"
Vertical Reinforcement	ICF with 6" Tie Spacing	As per table A.1.1.		As per table A.1.1.		As per table A.1.1.
Vertical Reinforcement	ICF with 8" Tie Spacing	As per table A.1.2.		As per table A.1.2.		As per table A.1.2.
Horizontal Reinforcement	Block Height of 12" and 18"	10 M @ 450 (18)		10 M @ 450 (18)		10 M @ 450 (18)
Horizontal Reinforcement	Block Height of 16"	10 M @ 400 (16)		10 M @ 400 (16)		10 M @ 400 (16)

**NOTES:**

1.  $S_{a,ICF}$  is equivalent spectral response acceleration for ICF walls as provided in Appendix A.
2. This table is to be used in conjunction with the "Design Limitations."
3. Provide two layers of the indicated horizontal and vertical distributed steel specified for 300mm (12") walls. Place each layer as shown in the rebar placement drawing.
4. All four sides of the building are to have a minimum number and length of shear walls that conforms to this table.
5. Use Table A.6 for buildings that do not meet the required wall length of this table.
6. Provide 2-15M concentrated reinforcement at each end of shear walls as shown in shear wall detail.
7. All concentrated reinforcement is to be continues to the bottom of the foundation wall. Provide lap splices as required.
8. Concentrated reinforcement is to be placed in accordance with Bar Placement Detail.

INSULATING CONCRETE FORMS MANUFACTURERS ASSOCIATION

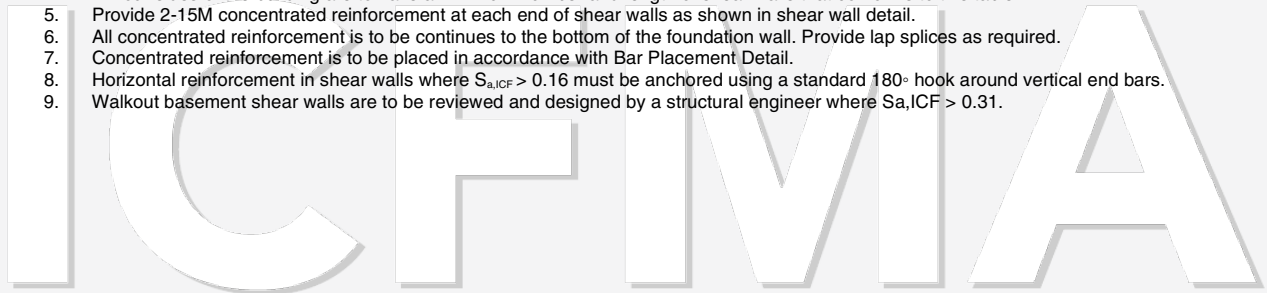

**Table A. 11.1600. – Above Grade Walkout Basement Shear Wall Length for Seismic Zone Classification,  $S_{a,ICF} \leq 0.31$  and Hourly Wind Pressure,  $q/50 \leq 1.05kPa$ , where Building Area  $\leq 1600ft^2$**

Wall Height m (ft)	Seismic Zone Classification							
	$S_{a,ICF} \leq 0.07$		$S_{a,ICF} \leq 0.11$		$S_{a,ICF} \leq 0.16$		$S_{a,ICF} \leq 0.31$	
Walkout Basement Wall of a Single Story ICF Structure Supporting Wood Framed Roof (TYPE W1)	6" & 8" Thick Wall	10" & 12" Thick Wall	6" & 8" Thick Wall	10" & 12" Thick Wall	6" & 8" Thick Wall	10" & 12" Thick Wall	6" & 8" Thick Wall	10" & 12" Thick Wall
		Number and length of shear walls provided						
2.44 (8)	1x 8'-0" 2x 4'-5" 3x 3'-7"	1x 6'-10" 2x 4'-10" 3x 3'-7"	1x 8'-3" 2x 5'-7" 3x 4'-5"	1x 8'-6" 2x 6'-0" 3x 4'-10"	1x 10'-0" 2x 6'-10" 3x 5'-7"	1x 10'-6" 2x 7'-2" 3x 5'-9"	1x 14'-5" 2x 9'-9" 3x 8'-0"	1x 15'-2" 2x 10'-5" 3x 8'-3"
2.75 (9)	1x 6'-6" 2x 4'-5" 3x 3'-7"	1x 7'-2" 2x 4'-10" 3x 4'-0"	1x 8'-5" 2x 5'-9" 3x 4'-10"	1x 8'-10" 2x 6'-0" 3x 4'-10"	1x 10'-3" 2x 7'-2" 3x 5'-7"	1x 10'-9" 2x 7'-4" 3x 5'-10"	1x 14'-6" 2x 10'-0" 3x 8'-3"	1x 15'-6" 2x 10'-8" 3x 8'-6"
3.05 (10)	1x 6'-10" 2x 4'-10" 3x 3'-7"	1x 7'-2" 2x 5'-2" 3x 4'-0"	1x 8'-8" 2x 6'-0" 3x 4'-10"	1x 9'-0" 2x 6'-3" 3x 5'-0"	1x 10'-6" 2x 7'-2" 3x 6'-0"	1x 11'-3" 2x 7'-7" 3x 6'-3"	1x 15'-0" 2x 10'-5" 3x 8'-5"	1x 15'-9" 2x 11'-0" 3x 8'-10"
3.66 (12)	1x 7'-2" 2x 5'-0" 3x 4'-0"	1x 8'-0" 2x 5'-2" 3x 4'-5"	1x 9'-3" 2x 6'-5" 3x 5'-2"	1x 9'-7" 2x 6'-6" 3x 5'-2"	1x 11'-3" 2x 7'-7" 3x 6'-5"	1x 11'-9" 2x 8'-0" 3x 6'-5"	1x 15'-9" 2x 11'-0" 3x 8'-10"	1x 16'-10" 2x 11'-6" 3x 9'-2"
Walkout Basement Walls of a Two Story Wood Framed Structure Supporting Wood Frame Floors and Roof (TYPE W2)	6" & 8" Thick Wall	10" & 12" Thick Wall	6" & 8" Thick Wall	10" & 12" Thick Wall	6" & 8" Thick Wall	10" & 12" Thick Wall	6" & 8" Thick Wall	10" & 12" Thick Wall
	Number and length of shear walls provided							
2.44 (8)	1x 8'-0" 2x 5'-6" 3x 4'-6"	1x 7'-7" 2x 5'-2" 3x 4'-6"	1x 8'-5" 2x 6'-0" 3x 4'-10"	1x 8'-5" 2x 6'-0" 3x 4'-10"	1x 10'-5" 2x 7'-2" 3x 5'-7"	1x 10'-5" 2x 7'-2" 3x 5'-7"	1x 14'-5" 2x 10'-0" 3x 8'-0"	1x 14'-5" 2x 10'-0" 3x 8'-0"
2.75 (9)	1x 8'-3" 2x 5'-8" 3x 4'-6"	1x 8'-0" 2x 5'-6" 3x 4'-6"	1x 8'-10" 2x 6'-5" 3x 4'-10"	1x 8'-10" 2x 6'-5" 3x 4'-10"	1x 10'-5" 2x 7'-6" 3x 5'-10"	1x 10'-5" 2x 7'-6" 3x 5'-10"	1x 14'-10" 2x 10'-5" 3x 8'-3"	1x 14'-10" 2x 10'-5" 3x 8'-3"
3.05 (10)	1x 8'-6" 2x 5'-9" 3x 4'-8"	1x 8'-0" 2x 5'-7" 3x 4'-8"	1x 8'-10" 2x 6'-5" 3x 4'-10"	1x 8'-10" 2x 6'-5" 3x 4'-10"	1x 10'-10" 2x 7'-6" 3x 5'-10"	1x 10'-10" 2x 7'-6" 3x 5'-10"	1x 15'-2" 2x 10'-8" 3x 8'-5"	1x 15'-2" 2x 10'-8" 3x 8'-5"
3.66 (12)	1x 9'-0" 2x 6'-3" 3x 5'-0"	1x 8'-6" 2x 6'-0" 3x 5'-0"	1x 9'-2" 2x 6'-5" 3x 5'-0"	1x 9'-2" 2x 6'-5" 3x 5'-0"	1x 11'-2" 2x 7'-7" 3x 6'-2"	1x 11'-2" 2x 7'-7" 3x 6'-2"	1x 15'-7" 2x 10'-10" 3x 8'-10"	1x 15'-7" 2x 10'-10" 3x 8'-10"
Walkout Basement Wall of a Two Story Building with Main Floor ICF Walls Supporting 2nd Story Wood Framed Walls, Floor and Roof (TYPE W3)	6" & 8" Thick Wall	10" & 12" Thick Wall	6" & 8" Thick Wall	10" & 12" Thick Wall	6" & 8" Thick Wall	10" & 12" Thick Wall	6" & 8" Thick Wall	10" & 12" Thick Wall
	Number and length of shear walls provided							
2.44 (8)	1x 8'-0" 2x 5'-7" 3x 4'-6"	1x 8'-0" 2x 5'-10" 3x 4'-6"	1x 10'-0" 2x 6'-10" 3x 5'-7"	1x 10'-0" 2x 6'-10" 3x 5'-7"	1x 12'-0" 2x 8'-5" 3x 6'-11"	1x 12'-5" 2x 8'-6" 3x 6'-11"	1x 17'-0" 2x 12'-0" 3x 9'-7"	1x 17'-7" 2x 12'-0" 3x 9'-9"
2.75 (9)	1x 8'-3" 2x 5'-10" 3x 4'-5"	1x 8'-3" 2x 5'-10" 3x 4'-6"	1x 10'-3" 2x 7'-2" 3x 5'-7"	1x 10'-5" 2x 7'-2" 3x 5'-9"	1x 12'-10" 2x 8'-6" 3x 6'-11"	1x 12'-10" 2x 8'-10" 3x 6'-11"	1x 17'-4" 2x 12'-3" 3x 9'-10"	1x 17'-9" 2x 12'-5" 3x 10'-0"
3.05 (10)	1x 8'-6" 2x 5'-10" 3x 4'-8"	1x 8'-6" 2x 5'-10" 3x 4'-6"	1x 10'-5" 2x 7'-2" 3x 5'-10"	1x 10'-6" 2x 7'-2" 3x 5'-10"	1x 12'-10" 2x 8'-10" 3x 6'-11"	1x 12'-10" 2x 9'-0" 3x 7'-2"	1x 17'-9" 2x 12'-5" 3x 10'-0"	1x 18'-3" 2x 12'-9" 3x 10'-3"
3.66 (12)	1x 9'-0" 2x 6'-3" 3x 5'-0"	1x 9'-0" 2x 6'-3" 3x 4'-10"	1x 10'-10" 2x 7'-7" 3x 6'-0"	1x 11'-0" 2x 7'-7" 3x 6'-0"	1x 13'-1" 2x 9'-1" 3x 7'-3"	1x 13'-4" 2x 9'-3" 3x 7'-6"	1x 18'-6" 2x 13'-0" 3x 10'-5"	1x 19'-0" 2x 13'-2" 3x 10'-8"
Walkout Basement Wall of Two Story ICF Structure Supporting Wood Frame Floors and Roof (TYPE W4)	6" & 8" Thick Wall	10" & 12" Thick Wall	6" & 8" Thick Wall	10" & 12" Thick Wall	6" & 8" Thick Wall	10" & 12" Thick Wall	6" & 8" Thick Wall	10" & 12" Thick Wall
	Number and length of shear walls provided							
2.44 (8)	1x 9'-0" 2x 6'-3" 3x 5'-1"	1x 9'-7" 2x 6'-5" 3x 5'-3"	1x 11'-4" 2x 8'-0" 3x 6'-6"	1x 12'-0" 2x 8'-3" 3x 6'-8"	1x 14'-0" 2x 9'-7" 3x 7'-9"	1x 14'-8" 2x 10'-0" 3x 8'-3"	1x 19'-8" 2x 13'-7" 3x 11'-0"	1x 20'-8" 2x 14'-5" 3x 11'-6"
2.75 (9)	1x 9'-2" 2x 6'-5" 3x 5'-3"	1x 9'-7" 2x 6'-4" 3x 5'-3"	1x 12'-0" 2x 8'-0" 3x 6'-6"	1x 12'-3" 2x 8'-5" 3x 6'-10"	1x 14'-5" 2x 9'-10" 3x 8'-0"	1x 15'-0" 2x 10'-3" 3x 8'-4"	1x 20'-0" 2x 14'-0" 3x 11'-2"	1x 21'-3" 2x 14'-8" 3x 11'-9"
3.05 (10)	1x 9'-4" 2x 6'-5" 3x 5'-3"	1x 9'-9" 2x 6'-8" 3x 5'-4"	1x 12'-0" 2x 8'-3" 3x 6'-10"	1x 12'-6" 2x 8'-6" 3x 7'-0"	1x 14'-5" 2x 10'-0" 3x 8'-3"	1x 15'-3" 2x 10'-6" 3x 8'-5"	1x 20'-6" 2x 14'-5" 3x 11'-6"	1x 21'-6" 2x 15'-0" 3x 12'-0"
3.66 (12)	1x 9'-9" 2x 6'-3" 3x 5'-4"	1x 10'-3" 2x 7'-0" 3x 5'-7"	1x 12'-4" 2x 8'-6" 3x 7'-0"	1x 13'-0" 2x 9'-0" 3x 7'-2"	1x 15'-0" 2x 10'-11" 3x 8'-10"	1x 15'-9" 2x 10'-11" 3x 8'-10"	1x 21'-3" 2x 14'-9" 3x 12'-0"	1x 22'-6" 2x 15'-6" 3x 12'-6"
Vertical Reinforcement	6", 8" and 10" thick wall	15 M @ 300 (12)	10 M @ 300 (12)	15 M @ 300 (12)	15 M @ 300 (12)	15 M @ 300 (12)	15 M @ 300 (12)	15 M @ 300 (12)
Horizontal Reinforcement	12" thick wall	10 M @ 300 (12)	10 M @ 300 (12)	10 M @ 300 (12)	10 M @ 300 (12)	10 M @ 300 (12)	10 M @ 300 (12)	10 M @ 300 (12)
Reinforcement	Block Height of 12" and 18"	10 M @ 450 (18)	10 M @ 450 (18)	10 M @ 450 (18)	10 M @ 450 (18)	10 M @ 450 (18)	10 M @ 450 (18)	10 M @ 450 (18)
Reinforcement	Block Height of 16"	10 M @ 400 (16)	10 M @ 400 (16)	10 M @ 400 (16)	10 M @ 400 (16)	10 M @ 400 (16)	10 M @ 400 (16)	10 M @ 400 (16)

**NOTES:**

1.  $S_{a,ICF}$  is equivalent spectral response acceleration for ICF walls as provided in Appendix A.
2. This table is to be used in conjunction with the "Design Limitations."
3. Provide two layers of the indicated horizontal and vertical distributed steel specified for 300mm (12") walls. Place each layer as shown in the rebar placement drawing.
4. All four sides of the building are to have a minimum number and length of shear walls that conforms to this table.
5. Provide 2-15M concentrated reinforcement at each end of shear walls as shown in shear wall detail.
6. All concentrated reinforcement is to be continues to the bottom of the foundation wall. Provide lap splices as required.
7. Concentrated reinforcement is to be placed in accordance with Bar Placement Detail.
8. Horizontal reinforcement in shear walls where  $S_{a,ICF} > 0.16$  must be anchored using a standard 180° hook around vertical end bars.
9. Walkout basement shear walls are to be reviewed and designed by a structural engineer where  $S_{a,ICF} > 0.31$ .



**INSULATING CONCRETE FORMS MANUFACTURERS ASSOCIATION**

**Table A.3.800. Above Grade Shear Wall Length for Seismic Zone Classification,  $S_{a,ICF} \leq 0.16$  and Hourly Wind Pressure,  $q_{1/50} \leq 0.5kPa$  (in a Building Without Walkout Basement), where Building Area  $\leq 800ft^2$**

Wall Height m (ft)	Seismic Zone Classification							
	$S_{a,ICF} \leq 0.07$		$S_{a,ICF} \leq 0.11$		$S_{a,ICF} \leq 0.16$			
<b>Second Floor Walls of Two Story ICF Structure Supporting Wood Frame Roof (TYPE A)</b>								
	6" & 8" Thick Wall		10" & 12" Thick Wall		6" & 8" Thick Wall		10" & 12" Thick Wall	
	Number and length of shear walls provided							
2.44 (8)	1 x 5'-2" 2 x 2'-8"	--	1 x 5'-2" 2 x 2'-8"	--	1 x 5'-2" 2 x 2'-8"	--	1 x 5'-2" 2 x 2'-8"	--
2.75 (9)	1 x 5'-2" 2 x 2'-8"	--	1 x 5'-2" 2 x 2'-8"	--	1 x 5'-2" 2 x 2'-8"	--	1 x 5'-2" 2 x 2'-11" 3 x 2'-8"	1 x 5'-2" 2 x 3'-3" 3 x 2'-8"
3.05 (10)	1 x 5'-2" 2 x 2'-8"	--	1 x 5'-2" 2 x 2'-8"	--	1 x 5'-2" 2 x 2'-11" 3 x 2'-8"	4 x 5'-6" 2 x 3'-7"	3 x 2'-8"	1 x 5'-10" 2 x 3'-7" 3 x 2'-8"
<b>Main Floor Walls of One Story ICF Structure Supporting Wood Frame Roof (TYPE B)</b>								
	6" & 8" Thick Wall		10" & 12" Thick Wall		6" & 8" Thick Wall		10" & 12" Thick Wall	
	Number and length of shear walls provided							
2.44 (8)	1 x 5'-2" 2 x 2'-8"	--	1 x 5'-2" 2 x 2'-8"	--	1 x 5'-2" 2 x 2'-8"	--	1 x 5'-2" 2 x 2'-8"	--
2.75 (9)	1 x 5'-2" 2 x 2'-8"	--	1 x 5'-2" 2 x 2'-8"	--	1 x 5'-2" 2 x 2'-8"	--	1 x 5'-2" 2 x 2'-8"	--
3.05 (10)	1 x 5'-2" 2 x 2'-8"	--	1 x 5'-2" 2 x 2'-8"	--	1 x 5'-2" 2 x 2'-8"	--	1 x 5'-2" 2 x 2'-11" 3 x 2'-8"	1 x 5'-2" 2 x 3'-3" 3 x 2'-8"
3.66 (12)	1 x 5'-2" 2 x 2'-8"	--	1 x 5'-2" 2 x 2'-8"	--	1 x 5'-2" 2 x 2'-11" 3 x 2'-8"	1 x 5'-2" 2 x 2'-11" 3 x 2'-8"	1 x 5'-10" 2 x 3'-11" 3 x 2'-11"	1 x 5'-10" 2 x 3'-7" 3 x 2'-11"
4.27 (14)	1 x 5'-2" 2 x 2'-8"	--	1 x 5'-2" 2 x 2'-8"	--	1 x 5'-2" 2 x 3'-3" 3 x 2'-8"	1 x 5'-2" 2 x 3'-7" 3 x 2'-8"	1 x 6'-1" 2 x 3'-11" 3 x 3'-3"	1 x 6'-6" 2 x 4'-7" 3 x 3'-7"
4.88 (16)	1 x 5'-2" 2 x 2'-8"	--	1 x 5'-2" 2 x 3'-3" 3 x 2'-8"	--	1 x 5'-2" 2 x 3'-3" 3 x 2'-8"	1 x 5'-10" 2 x 3'-11" 3 x 2'-11"	1 x 6'-6" 2 x 4'-3" 3 x 3'-3"	1 x 7'-2" 2 x 4'-11" 3 x 3'-11"
<b>Main Floor Walls of Two Story Structure Supporting 2nd Story Wood Framed Walls, Floor and Roof (TYPE C)</b>								
	6" & 8" Thick Wall		10" & 12" Thick Wall		6" & 8" Thick Wall		10" & 12" Thick Wall	
	Number and length of shear walls provided							
2.44 (8)	1 x 5'-2" 2 x 2'-8"	--	1 x 5'-2" 2 x 2'-8"	--	1 x 5'-10" 2 x 3'-11" 3 x 3'-3"	1 x 5'-10" 2 x 4'-3" 3 x 3'-3"	1 x 7'-2" 2 x 4'-7" 3 x 3'-7"	1 x 7'-6" 2 x 4'-7" 3 x 3'-7"
2.75 (9)	1 x 5'-2" 2 x 2'-11" 3 x 2'-8"	--	1 x 5'-2" 2 x 2'-11" 3 x 2'-8"	--	1 x 5'-10" 2 x 4'-3" 3 x 3'-3"	1 x 6'-6" 2 x 4'-7" 3 x 3'-3"	1 x 7'-10" 2 x 4'-11" 3 x 3'-11"	1 x 7'-10" 2 x 4'-11" 3 x 3'-11"
3.05 (10)	1 x 5'-2" 2 x 3'-3" 3 x 2'-8"	--	1 x 5'-2" 2 x 3'-3" 3 x 2'-8"	--	1 x 6'-2" 2 x 4'-9" 3 x 3'-11"	1 x 6'-6" 2 x 4'-9" 3 x 3'-11"	1 x 7'-10" 2 x 5'-2" 3 x 4'-3"	1 x 8'-2" 2 x 5'-2" 3 x 4'-3"
3.66 (12)	1 x 5'-6" 2 x 3'-7" 3 x 2'-8"	--	1 x 5'-6" 2 x 3'-7" 3 x 2'-8"	--	1 x 6'-10" 2 x 5'-5" 3 x 4'-3"	1 x 6'-10" 2 x 5'-5" 3 x 4'-3"	1 x 8'-5" 2 x 5'-10" 3 x 4'-7"	1 x 8'-5" 2 x 5'-10" 3 x 4'-7"
4.27 (14)	1 x 5'-6" 2 x 3'-7" 3 x 2'-11"	--	1 x 5'-6" 2 x 3'-11" 3 x 2'-11"	--	1 x 7'-2" 2 x 5'-6" 3 x 4'-7"	1 x 7'-6" 2 x 5'-10" 3 x 4'-7"	1 x 8'-5" 2 x 5'-10" 3 x 4'-7"	1 x 9'-1" 2 x 6'-6" 3 x 4'-11"
4.88 (16)	1 x 5'-6" 2 x 3'-7" 3 x 2'-11"	--	1 x 5'-10" 2 x 3'-11" 3 x 3'-3"	--	1 x 7'-2" 2 x 5'-10" 3 x 4'-11"	1 x 7'-10" 2 x 6'-2" 3 x 4'-11"	1 x 8'-5" 2 x 5'-10" 3 x 4'-11"	1 x 9'-5" 2 x 6'-6" 3 x 4'-11"
<b>Main Floor Walls of Two Story ICF Structure Supporting Wood Frame Floors and Roof (TYPE D)</b>								
	6" & 8" Thick Wall		10" & 12" Thick Wall		6" & 8" Thick Wall		10" & 12" Thick Wall	
	Number and length of shear walls provided							
2.44 (8)	1 x 5'-10" 2 x 3'-7" 3 x 2'-8"	--	1 x 5'-10" 2 x 3'-7" 3 x 2'-11"	--	1 x 7'-2" 2 x 4'-7" 3 x 3'-7"	1 x 7'-10" 2 x 5'-2" 3 x 3'-11"	1 x 9'-1" 2 x 5'-10" 3 x 4'-7"	1 x 10'-5" 2 x 6'-6" 3 x 5'-2"
2.75 (9)	1 x 5'-10" 2 x 3'-11" 3 x 2'-8"	--	1 x 6'-6" 2 x 3'-11" 3 x 3'-3"	--	1 x 7'-10" 2 x 4'-11" 3 x 3'-11"	1 x 8'-5" 2 x 5'-2" 3 x 3'-11"	1 x 9'-9" 2 x 6'-2" 3 x 5'-2"	1 x 10'-5" 2 x 7'-2" 3 x 5'-2"
3.05 (10)	1 x 6'-2" 2 x 3'-11" 3 x 2'-11"	--	1 x 6'-6" 2 x 4'-3" 3 x 3'-3"	--	1 x 8'-5" 2 x 5'-2" 3 x 3'-11"	1 x 8'-5" 2 x 5'-6" 3 x 4'-7"	1 x 10'-1" 2 x 6'-6" 3 x 5'-2"	1 x 11'-1" 2 x 7'-2" 3 x 5'-6"
3.66 (12)	1 x 6'-6" 2 x 4'-7" 3 x 3'-3"	--	1 x 6'-6" 2 x 4'-7" 3 x 3'-3"	--	1 x 8'-5" 2 x 5'-10" 3 x 4'-7"	1 x 8'-9" 2 x 5'-10" 3 x 4'-7"	1 x 10'-5" 2 x 7'-2" 3 x 5'-10"	1 x 11'-1" 2 x 7'-2" 3 x 5'-10"
4.27 (14)	1 x 6'-6" 2 x 4'-7" 3 x 3'-7"	--	1 x 7'-2" 2 x 4'-11" 3 x 3'-11"	--	1 x 8'-5" 2 x 5'-10" 3 x 4'-7"	1 x 8'-5" 2 x 5'-10" 3 x 4'-7"	1 x 10'-5" 2 x 7'-2" 3 x 5'-10"	1 x 11'-8" 2 x 7'-10" 3 x 6'-6"
4.88 (16)	1 x 6'-6" 2 x 4'-7" 3 x 3'-7"	--	1 x 7'-6" 2 x 4'-11" 3 x 3'-11"	--	1 x 8'-5" 2 x 5'-10" 3 x 4'-7"	1 x 8'-5" 2 x 5'-10" 3 x 4'-7"	1 x 10'-5" 2 x 7'-2" 3 x 5'-10"	1 x 11'-8" 2 x 8'-2" 3 x 6'-6"
Vertical Reinforcement	ICF with 6" Tie Spacing	As per table A.1.1.			As per table A.1.1.			As per table A.1.1.
Vertical Reinforcement	ICF with 8" Tie Spacing	As per table A.1.2.			As per table A.1.2.			As per table A.1.2.
Horizontal Reinforcement	Block Height of 12" and 18"	10 M @	450 (18)	10 M @	450 (18)	10 M @	450 (18)	
Horizontal Reinforcement	Block Height of 16"	10 M @	400 (16)	10 M @	400 (16)	10 M @	400 (16)	

**NOTES:**

1.  $S_{a,ICF}$  is equivalent spectral response acceleration for ICF walls as provided in Appendix A.
2. This table is to be used in conjunction with the "Design Limitations."
3. Provide two layers of the indicated horizontal and vertical distributed steel specified for 300mm (12") walls. Place each layer as shown in the rebar placement drawing.
4. All four sides of the building are to have a minimum number and length of shear walls that conforms to this table.
5. Use Table A.6 for buildings that do not meet the required wall length of this table.
6. Provide 2-15M concentrated reinforcement at each end of shear walls as shown in shear wall detail.
7. All concentrated reinforcement is to be continued to the bottom of the foundation wall. Provide lap splices as required.
8. Concentrated reinforcement is to be placed in accordance with Bar Placement Detail.

**INSULATING CONCRETE FORMS MANUFACTURERS ASSOCIATION**



**Table A.4.800. Above Grade Shear Wall Length for Seismic Zone Classification,  $S_{a,ICF} \leq 0.16$  and Hourly Wind Pressure,  $0.5kPa < q1/50 \leq 0.75kPa$  (in a Building Without Walkout Basement), where Building Area  $\leq 800ft^2$**

Wall Height m (ft)	Seismic Zone Classification					
	$S_{a,ICF} \leq 0.07$		$S_{a,ICF} \leq 0.11$		$S_{a,ICF} \leq 0.16$	
<b>Second Floor Walls of Two Story ICF Structure Supporting Wood Frame Roof (TYPE A)</b>						
	6" & 8" Thick Wall		10" & 12" Thick Wall		6" & 8" Thick Wall	
	Number and length of shear walls provided					
2.44 (8)	1 x 5'-2" 2 x 2'-8"	--	1 x 5'-2" 2 x 2'-8"	--	1 x 5'-2" 2 x 2'-8"	--
2.75 (9)	1 x 5'-2" 2 x 2'-8"	--	1 x 5'-2" 2 x 2'-8"	--	1 x 5'-2" 2 x 2'-8"	--
3.05 (10)	1 x 5'-2" 2 x 2'-8"	--	1 x 5'-2" 2 x 2'-8"	--	1 x 5'-2" 2 x 2'-8"	--
4.27 (14)	1 x 5'-2" 2 x 2'-8"	--	1 x 5'-2" 2 x 2'-8"	--	1 x 5'-2" 2 x 2'-8"	--
4.88 (16)	1 x 5'-2" 2 x 2'-8"	--	1 x 5'-2" 2 x 2'-8"	--	1 x 5'-2" 2 x 2'-8"	--
<b>Main Floor Walls of One Story ICF Structure Supporting Wood Frame Roof (TYPE B)</b>						
	6" & 8" Thick Wall		10" & 12" Thick Wall		6" & 8" Thick Wall	
	Number and length of shear walls provided					
2.44 (8)	1 x 5'-2" 2 x 2'-8"	--	1 x 5'-2" 2 x 2'-8"	--	1 x 5'-2" 2 x 2'-8"	--
2.75 (9)	1 x 5'-2" 2 x 2'-8"	--	1 x 5'-2" 2 x 2'-8"	--	1 x 5'-2" 2 x 2'-8"	--
3.05 (10)	1 x 5'-2" 2 x 2'-8"	--	1 x 5'-2" 2 x 2'-8"	--	1 x 5'-2" 2 x 2'-8"	--
3.66 (12)	1 x 5'-2" 2 x 2'-8"	--	1 x 5'-2" 2 x 2'-8"	--	1 x 5'-2" 2 x 2'-8"	--
4.27 (14)	1 x 5'-2" 2 x 2'-8"	--	1 x 5'-2" 2 x 2'-8"	--	1 x 5'-2" 2 x 2'-8"	--
4.88 (16)	1 x 5'-2" 2 x 2'-8"	--	1 x 5'-2" 2 x 2'-8"	--	1 x 5'-2" 2 x 2'-8"	--
<b>Main Floor Walls of Two Story Structure Supporting 2nd Story Wood Framed Walls, Floor and Roof (TYPE C)</b>						
	6" & 8" Thick Wall		10" & 12" Thick Wall		6" & 8" Thick Wall	
	Number and length of shear walls provided					
2.44 (8)	1 x 5'-2" 2 x 2'-11" 3 x 2'-8"	1 x 5'-2" 2 x 2'-8"	--	1 x 5'-10" 2 x 3'-11" 3 x 3'-3"	1 x 5'-10" 2 x 4'-3" 3 x 3'-3"	1 x 7'-6" 2 x 4'-11" 3 x 3'-11"
2.75 (9)	1 x 5'-2" 2 x 2'-11" 3 x 2'-8"	1 x 5'-2" 2 x 2'-11" 3 x 2'-8"	--	1 x 5'-10" 2 x 4'-3" 3 x 3'-3"	1 x 6'-6" 2 x 4'-7" 3 x 3'-3"	1 x 7'-10" 2 x 4'-11" 3 x 3'-11"
3.05 (10)	1 x 5'-2" 2 x 3'-3" 3 x 2'-8"	1 x 5'-2" 2 x 3'-3" 3 x 2'-8"	--	1 x 6'-6" 2 x 4'-9" 3 x 3'-11"	1 x 6'-6" 2 x 4'-9" 3 x 3'-11"	1 x 8'-2" 2 x 5'-2" 3 x 4'-3"
3.66 (12)	1 x 5'-6" 2 x 3'-7" 3 x 2'-8"	1 x 5'-6" 2 x 3'-7" 3 x 2'-8"	--	1 x 6'-10" 2 x 5'-5" 3 x 4'-3"	1 x 6'-10" 2 x 5'-5" 3 x 4'-3"	1 x 8'-5" 2 x 5'-10" 3 x 4'-7"
4.27 (14)	1 x 5'-6" 2 x 3'-7" 3 x 2'-11"	1 x 5'-6" 2 x 3'-11" 3 x 2'-11"	--	1 x 7'-2" 2 x 5'-6" 3 x 4'-7"	1 x 7'-6" 2 x 5'-10" 3 x 4'-7"	1 x 8'-5" 2 x 5'-10" 3 x 4'-7"
4.88 (16)	1 x 5'-6" 2 x 3'-7" 3 x 2'-11"	1 x 5'-10" 2 x 3'-11" 3 x 3'-3"	--	1 x 7'-2" 2 x 5'-10" 3 x 4'-11"	1 x 7'-10" 2 x 6'-2" 3 x 4'-11"	1 x 8'-5" 2 x 5'-10" 3 x 4'-11"
<b>Main Floor Walls of Two Story ICF Structure Supporting Wood Frame Floors and Roof (TYPE D)</b>						
	6" & 8" Thick Wall		10" & 12" Thick Wall		6" & 8" Thick Wall	
	Number and length of shear walls provided					
2.44 (8)	1 x 5'-10" 2 x 3'-7" 3 x 2'-11"	1 x 5'-10" 2 x 3'-7" 3 x 2'-11"	--	1 x 7'-2" 2 x 4'-7" 3 x 3'-7"	1 x 7'-10" 2 x 5'-2" 3 x 3'-11"	1 x 9'-9" 2 x 5'-10" 3 x 4'-7"
2.75 (9)	1 x 5'-10" 2 x 3'-11" 3 x 2'-11"	1 x 6'-6" 2 x 3'-11" 3 x 3'-3"	--	1 x 7'-10" 2 x 4'-11" 3 x 3'-11"	1 x 8'-5" 2 x 5'-2" 3 x 3'-11"	1 x 9'-9" 2 x 6'-2" 3 x 5'-2"
3.05 (10)	1 x 6'-2" 2 x 4'-3" 3 x 3'-3"	1 x 6'-6" 2 x 4'-3" 3 x 3'-3"	--	1 x 8'-5" 2 x 5'-6" 3 x 4'-3"	1 x 8'-5" 2 x 5'-6" 3 x 4'-7"	1 x 10'-1" 2 x 6'-10" 3 x 5'-2"
3.66 (12)	1 x 6'-6" 2 x 4'-7" 3 x 3'-3"	1 x 6'-10" 2 x 4'-7" 3 x 3'-7"	--	1 x 8'-5" 2 x 5'-10" 3 x 4'-7"	1 x 8'-9" 2 x 5'-10" 3 x 4'-7"	1 x 10'-5" 2 x 7'-2" 3 x 5'-10"
4.27 (14)	1 x 6'-6" 2 x 4'-7" 3 x 3'-7"	1 x 7'-2" 2 x 4'-11" 3 x 3'-11"	--	1 x 8'-5" 2 x 5'-10" 3 x 4'-7"	1 x 9'-5" 2 x 6'-2" 3 x 5'-2"	1 x 10'-5" 2 x 7'-2" 3 x 5'-10"
4.88 (16)	1 x 6'-6" 2 x 4'-7" 3 x 3'-7"	1 x 7'-6" 2 x 4'-11" 3 x 3'-11"	--	1 x 8'-5" 2 x 5'-10" 3 x 4'-7"	1 x 9'-5" 2 x 6'-6" 3 x 5'-2"	1 x 10'-5" 2 x 7'-2" 3 x 5'-10"
Vertical Reinforcement	ICF with 6" Tie Spacing	As per table A.1.1.		As per table A.1.1.		As per table A.1.1.
	ICF with 8" Tie Spacing	As per table A.1.2.		As per table A.1.2.		As per table A.1.2.
Horizontal Reinforcement	Block Height of 12" and 18"	10 M @ 450 (18)		10 M @ 450 (18)		10 M @ 450 (18)
	Block Height of 16"	10 M @ 400 (16)		10 M @ 400 (16)		10 M @ 400 (16)

**NOTES:**

1.  $S_{a,ICF}$  is equivalent spectral response acceleration for ICF walls as provided in Appendix A.
2. This table is to be used in conjunction with the "Design Limitations."
3. Provide two layers of the indicated horizontal and vertical distributed steel specified for 300mm (12") walls. Place each layer as shown in the rebar placement drawing.
4. All four sides of the building are to have a minimum number and length of shear walls that conforms to this table.
5. Use Table A.6 for buildings that do not meet the required wall length of this table.
6. Provide 2-15M concentrated reinforcement at each end of shear walls as shown in shear wall detail.
7. All concentrated reinforcement is to be continues to the bottom of the foundation wall. Provide lap splices as required.
8. Concentrated reinforcement is to be placed in accordance with Bar Placement Detail.

INSULATING CONCRETE FORMS MANUFACTURERS ASSOCIATION

**Table A.5.800. Above Grade Shear Wall Length for Seismic Zone Classification,  $S_{a,ICF} \leq 0.16$  and Hourly Wind Pressure,  $0.5kPa < q1/50 \leq 0.75kPa$  (in a Building Without Walkout Basement), where Building Area  $\leq 800ft^2$**

Wall Height m (ft)	Seismic Zone Classification					
	$S_{a,ICF} \leq 0.07$		$S_{a,ICF} \leq 0.11$		$S_{a,ICF} \leq 0.16$	
<b>Second Floor Walls of Two Story ICF Structure Supporting Wood Frame Roof (TYPE A)</b>						
	6" & 8" Thick Wall		10" & 12" Thick Wall		6" & 8" Thick Wall	
	Number and length of shear walls provided					
2.44 (8)	1 x 5'-2" 2 x 2'-8"	--	1 x 5'-2" 2 x 2'-8"	--	1 x 5'-2" 2 x 2'-8"	--
2.75 (9)	1 x 5'-2" 2 x 2'-8"	--	1 x 5'-2" 2 x 2'-8"	--	1 x 5'-2" 2 x 2'-8"	--
3.05 (10)	1 x 5'-2" 2 x 2'-8"	--	1 x 5'-2" 2 x 2'-8"	--	1 x 5'-2" 2 x 2'-8"	--
<b>Main Floor Walls of One Story ICF Structure Supporting Wood Frame Roof (TYPE B)</b>						
	6" & 8" Thick Wall		10" & 12" Thick Wall		6" & 8" Thick Wall	
	Number and length of shear walls provided					
2.44 (8)	1 x 5'-2" 2 x 2'-8"	--	1 x 5'-2" 2 x 2'-8"	--	1 x 5'-2" 2 x 2'-8"	--
2.75 (9)	1 x 5'-2" 2 x 2'-8"	--	1 x 5'-2" 2 x 2'-8"	--	1 x 5'-2" 2 x 2'-8"	--
3.05 (10)	1 x 5'-2" 2 x 2'-8"	--	1 x 5'-2" 2 x 2'-8"	--	1 x 5'-2" 2 x 2'-8"	--
3.66 (12)	1 x 5'-2" 2 x 2'-8"	--	1 x 5'-2" 2 x 2'-8"	--	1 x 5'-2" 2 x 2'-8"	--
4.27 (14)	1 x 5'-2" 2 x 2'-8"	--	1 x 5'-2" 2 x 2'-8"	--	1 x 5'-2" 2 x 2'-8"	--
4.88 (16)	1 x 5'-2" 2 x 2'-8"	--	1 x 5'-2" 2 x 2'-8"	--	1 x 5'-2" 2 x 2'-8"	--
<b>Main Floor Walls of Two Story Structure Supporting 2nd Story Wood Framed Walls, Floor and Roof (TYPE C)</b>						
	6" & 8" Thick Wall		10" & 12" Thick Wall		6" & 8" Thick Wall	
	Number and length of shear walls provided					
2.44 (8)	1 x 5'-2" 2 x 2'-11" 3 x 2'-8"	1 x 5'-2" 2 x 2'-8"	--	1 x 5'-10" 2 x 3'-11" 3 x 3'-3"	1 x 5'-10" 2 x 4'-3" 3 x 3'-3"	1 x 7'-6" 2 x 4'-11" 3 x 3'-11"
2.75 (9)	1 x 5'-2" 2 x 2'-11" 3 x 2'-8"	1 x 5'-2" 2 x 3'-3"	3 x 2'-8"	1 x 5'-10" 2 x 4'-3" 3 x 3'-3"	1 x 6'-6" 2 x 4'-7" 3 x 3'-3"	1 x 7'-10" 2 x 4'-11" 3 x 3'-11"
3.05 (10)	1 x 5'-2" 2 x 3'-3" 3 x 2'-8"	1 x 5'-2" 2 x 3'-3" 3 x 2'-8"	1 x 6'-6" 2 x 4'-9" 3 x 3'-11"	1 x 6'-6" 2 x 4'-9" 3 x 3'-11"	1 x 8'-2" 2 x 5'-6" 3 x 4'-3"	1 x 8'-2" 2 x 5'-2" 3 x 4'-3"
3.66 (12)	1 x 5'-6" 2 x 3'-7" 3 x 2'-8"	1 x 5'-6" 2 x 3'-7" 3 x 2'-8"	1 x 6'-10" 2 x 5'-5" 3 x 4'-3"	1 x 6'-10" 2 x 5'-5" 3 x 4'-3"	1 x 8'-5" 2 x 5'-10" 3 x 4'-7"	1 x 8'-5" 2 x 5'-10" 3 x 4'-7"
4.27 (14)	1 x 5'-6" 2 x 3'-7" 3 x 2'-11"	1 x 5'-6" 2 x 3'-11" 3 x 2'-11"	1 x 7'-2" 2 x 5'-6" 3 x 4'-7"	1 x 7'-2" 2 x 5'-6" 3 x 4'-7"	1 x 8'-5" 2 x 5'-10" 3 x 4'-7"	1 x 9'-1" 2 x 6'-6" 3 x 4'-11"
4.88 (16)	1 x 5'-6" 2 x 3'-7" 3 x 2'-11"	1 x 5'-10" 2 x 3'-11" 3 x 3'-3"	1 x 7'-2" 2 x 5'-10" 3 x 4'-11"	1 x 7'-10" 2 x 6'-2" 3 x 4'-11"	1 x 8'-5" 2 x 5'-10" 3 x 4'-11"	1 x 9'-5" 2 x 6'-6" 3 x 4'-11"
<b>Main Floor Walls of Two Story ICF Structure Supporting Wood Frame Floors and Roof (TYPE D)</b>						
	6" & 8" Thick Wall		10" & 12" Thick Wall		6" & 8" Thick Wall	
	Number and length of shear walls provided					
2.44 (8)	1 x 5'-10" 2 x 3'-7" 3 x 2'-11"	1 x 5'-10" 2 x 3'-7" 3 x 2'-11"	1 x 7'-2" 2 x 4'-11" 3 x 3'-11"	1 x 7'-10" 2 x 5'-2" 3 x 3'-11"	1 x 9'-1" 2 x 5'-10" 3 x 4'-7"	1 x 10'-5" 2 x 6'-6" 3 x 5'-2"
2.75 (9)	1 x 5'-10" 2 x 3'-11" 3 x 2'-11"	1 x 6'-6" 2 x 4'-3" 3 x 3'-3"	1 x 7'-10" 2 x 4'-11" 3 x 3'-11"	1 x 8'-5" 2 x 5'-6" 3 x 4'-3"	1 x 9'-9" 2 x 6'-2" 3 x 5'-2"	1 x 10'-5" 2 x 7'-2" 3 x 5'-2"
3.05 (10)	1 x 6'-2" 2 x 4'-3" 3 x 3'-3"	1 x 6'-6" 2 x 4'-3" 3 x 3'-3"	1 x 8'-5" 2 x 5'-6" 3 x 4'-3"	1 x 8'-5" 2 x 5'-6" 3 x 4'-7"	1 x 10'-1" 2 x 6'-10" 3 x 5'-2"	1 x 11'-1" 2 x 7'-2" 3 x 5'-6"
3.66 (12)	1 x 6'-6" 2 x 4'-7" 3 x 3'-3"	1 x 6'-10" 2 x 4'-7" 3 x 3'-7"	1 x 8'-5" 2 x 5'-10" 3 x 4'-7"	1 x 8'-9" 2 x 5'-10" 3 x 4'-7"	1 x 10'-5" 2 x 7'-2" 3 x 5'-10"	1 x 11'-1" 2 x 7'-2" 3 x 5'-10"
4.27 (14)	1 x 6'-6" 2 x 4'-7" 3 x 3'-7"	1 x 7'-2" 2 x 4'-11" 3 x 3'-11"	1 x 8'-5" 2 x 5'-10" 3 x 4'-7"	1 x 9'-5" 2 x 6'-2" 3 x 5'-2"	1 x 10'-5" 2 x 7'-2" 3 x 5'-10"	1 x 11'-8" 2 x 7'-10" 3 x 6'-6"
4.88 (16)	1 x 6'-6" 2 x 4'-7" 3 x 3'-7"	1 x 7'-6" 2 x 4'-11" 3 x 3'-11"	1 x 8'-5" 2 x 5'-10" 3 x 4'-7"	1 x 9'-5" 2 x 6'-6" 3 x 5'-2"	1 x 10'-5" 2 x 7'-2" 3 x 5'-10"	1 x 11'-8" 2 x 8'-2" 3 x 6'-6"
Vertical Reinforcement	ICF with 6" Tie Spacing	As per table A.1.1.		As per table A.1.1.		As per table A.1.1.
	ICF with 8" Tie Spacing	As per table A.1.2.		As per table A.1.2.		As per table A.1.2.
Horizontal Reinforcement	Block Height of 12" and 18"	10 M @ 450 (18)		10 M @ 450 (18)		10 M @ 450 (18)
	Block Height of 16"	10 M @ 400 (16)		10 M @ 400 (16)		10 M @ 400 (16)

**NOTES:**

1.  $S_{a,ICF}$  is equivalent spectral response acceleration for ICF walls as provided in Appendix A.
2. This table is to be used in conjunction with the "Design Limitations."
3. Provide two layers of the indicated horizontal and vertical distributed steel specified for 300mm (12") walls. Place each layer as shown in the rebar placement drawing.
4. All four sides of the building are to have a minimum number and length of shear walls that conforms to this table.
5. Use Table A.6 for buildings that do not meet the required wall length of this table.
6. Provide 2-15M concentrated reinforcement at each end of shear walls as shown in shear wall detail.
7. All concentrated reinforcement is to be continues to the bottom of the foundation wall. Provide lap splices as required.
8. Concentrated reinforcement is to be placed in accordance with Bar Placement Detail.

INSULATING CONCRETE FORMS MANUFACTURERS ASSOCIATION

**Table A.6.800. Above Grade Shear Wall Length for Seismic Zone Classification,  $S_{a,ICF} > 0.16$  and Hourly Wind Pressure,  $q_{1/50} \leq 1.05kPa$  (in a Building Without Walkout Basement), where Building Area  $\leq 800ft^2$**

Wall Height m (ft)	Seismic Zone Classification							
	$S_{a,ICF} \leq 0.16$		$S_{a,ICF} \leq 0.31$		$S_{a,ICF} \leq 0.53$		$S_{a,ICF} \leq 0.79$	
<b>Second Floor Walls of Two Story ICF Structure Supporting Wood Frame Roof (TYPE A)</b>								
	6" & 8" Thick Wall		10" & 12" Thick Wall		6" & 8" Thick Wall		10" & 12" Thick Wall	
	Number and length of shear walls provided							
2.44 (8)	1x 5'-2"	2x 2'-8"	1x 5'-2"	2x 2'-8"	1x 5'-2"	2x 4'-0"	1x 5'-2"	2x 4'-0"
2.75 (9)	1x 5'-2"	2x 2'-8"	1x 5'-2"	2x 2'-8"	1x 5'-2"	2x 4'-0"	1x 5'-2"	2x 4'-0"
3.05 (10)	1x 5'-2"	2x 3'-3"	1x 5'-2"	2x 3'-3"	1x 5'-2"	2x 5'-0"	1x 5'-2"	2x 5'-0"
3.66 (12)	1x 5'-2"	2x 3'-11"	1x 5'-2"	2x 3'-11"	1x 5'-2"	2x 6'-0"	1x 5'-2"	2x 6'-0"
4.27 (14)	1x 5'-2"	2x 3'-3"	1x 5'-2"	2x 3'-3"	1x 5'-2"	2x 7'-0"	1x 5'-2"	2x 7'-0"
4.88 (16)	1x 5'-2"	2x 3'-7"	1x 5'-2"	2x 3'-7"	1x 5'-2"	2x 8'-0"	1x 5'-2"	2x 8'-0"
<b>Main Floor Walls of One Story ICF Structure Supporting Wood Frame Roof (TYPE B)</b>								
	6" & 8" Thick Wall		10" & 12" Thick Wall		6" & 8" Thick Wall		10" & 12" Thick Wall	
	Number and length of shear walls provided							
2.44 (8)	1x 5'-2"	2x 2'-8"	1x 5'-2"	2x 2'-8"	1x 5'-2"	2x 4'-0"	1x 5'-2"	2x 4'-0"
2.75 (9)	1x 5'-2"	2x 2'-8"	1x 5'-2"	2x 2'-8"	1x 5'-2"	2x 4'-0"	1x 5'-2"	2x 4'-0"
3.05 (10)	1x 5'-2"	2x 3'-3"	1x 5'-2"	2x 3'-3"	1x 5'-2"	2x 5'-0"	1x 5'-2"	2x 5'-0"
3.66 (12)	1x 5'-2"	2x 3'-11"	1x 5'-2"	2x 3'-11"	1x 5'-2"	2x 6'-0"	1x 5'-2"	2x 6'-0"
4.27 (14)	1x 5'-2"	2x 3'-3"	1x 5'-2"	2x 3'-3"	1x 5'-2"	2x 7'-0"	1x 5'-2"	2x 7'-0"
4.88 (16)	1x 5'-2"	2x 3'-7"	1x 5'-2"	2x 3'-7"	1x 5'-2"	2x 8'-0"	1x 5'-2"	2x 8'-0"
<b>Main Floor Walls of Two Story Structure Supporting 2nd Story Wood Framed Walls, Floor and Roof (TYPE C)</b>								
	6" & 8" Thick Wall		10" & 12" Thick Wall		6" & 8" Thick Wall		10" & 12" Thick Wall	
	Number and length of shear walls provided							
2.44 (8)	1x 5'-10"	2x 3'-11"	1x 5'-10"	2x 3'-11"	1x 5'-10"	2x 5'-0"	1x 5'-10"	2x 5'-0"
2.75 (9)	1x 5'-10"	2x 3'-11"	1x 5'-10"	2x 3'-11"	1x 5'-10"	2x 5'-0"	1x 5'-10"	2x 5'-0"
3.05 (10)	1x 6'-6"	2x 4'-3"	1x 6'-6"	2x 4'-3"	1x 6'-6"	2x 6'-0"	1x 6'-6"	2x 6'-0"
3.66 (12)	1x 6'-6"	2x 4'-7"	1x 6'-6"	2x 4'-7"	1x 6'-6"	2x 6'-0"	1x 6'-6"	2x 6'-0"
4.27 (14)	1x 7'-2"	2x 4'-11"	1x 7'-2"	2x 4'-11"	1x 7'-2"	2x 7'-0"	1x 7'-2"	2x 7'-0"
4.88 (16)	1x 7'-2"	2x 4'-11"	1x 7'-2"	2x 4'-11"	1x 7'-2"	2x 8'-0"	1x 7'-2"	2x 8'-0"
<b>Main Floor Walls of Two Story ICF Structure Supporting Wood Frame Floors and Roof (TYPE D)</b>								
	6" & 8" Thick Wall		10" & 12" Thick Wall		6" & 8" Thick Wall		10" & 12" Thick Wall	
	Number and length of shear walls provided							
2.44 (8)	1x 7'-2"	2x 4'-11"	1x 7'-2"	2x 4'-11"	1x 7'-2"	2x 7'-0"	1x 7'-2"	2x 7'-0"
2.75 (9)	1x 7'-2"	2x 4'-11"	1x 7'-2"	2x 4'-11"	1x 7'-2"	2x 7'-0"	1x 7'-2"	2x 7'-0"
3.05 (10)	1x 7'-2"	2x 5'-2"	1x 7'-2"	2x 5'-2"	1x 7'-2"	2x 7'-0"	1x 7'-2"	2x 7'-0"
3.66 (12)	1x 7'-2"	2x 5'-6"	1x 7'-2"	2x 5'-6"	1x 7'-2"	2x 7'-0"	1x 7'-2"	2x 7'-0"
4.27 (14)	1x 8'-5"	2x 5'-10"	1x 8'-5"	2x 5'-10"	1x 8'-5"	2x 8'-0"	1x 8'-5"	2x 8'-0"
4.88 (16)	1x 8'-5"	2x 5'-10"	1x 8'-5"	2x 5'-10"	1x 8'-5"	2x 8'-0"	1x 8'-5"	2x 8'-0"
Vertical Reinforcement	ICF with 6" The Spec'ing	As per table A.2.1.	As per table A.2.1.	As per table A.2.1.	As per table A.2.1.	As per table A.2.1.	As per table A.2.1.	As per table A.2.1.
Horizontal Reinforcement	ICF with 8" The Spec'ing	As per table A.2.2.	As per table A.2.2.	As per table A.2.2.	As per table A.2.2.	As per table A.2.2.	As per table A.2.2.	As per table A.2.2.
Horizontal Reinforcement	Block Height of 12" and 18"	As per table A.2.1.	As per table A.2.1.	As per table A.2.1.	As per table A.2.1.	As per table A.2.1.	As per table A.2.1.	As per table A.2.1.
Horizontal Reinforcement	Block Height of 16"	As per table A.2.2.	As per table A.2.2.	As per table A.2.2.	As per table A.2.2.	As per table A.2.2.	As per table A.2.2.	As per table A.2.2.

**NOTES:**

1.  $S_{a,ICF}$  is equivalent spectral response acceleration for ICF walls as provided in Appendix A.
2. This table is to be used in conjunction with the "Design Limitations."
3. Provide two layers of the indicated horizontal and vertical distributed steel specified for 300mm (12") walls. Place each layer as shown in the rebar placement drawing.
4. All four sides of the building are to have a minimum number and length of shear walls that conforms to this table.
5. Provide 2-15M concentrated reinforcement at each end of shear walls as shown in shear wall detail.
6. All concentrated reinforcement is to be continues to the bottom of the foundation wall. Provide lap splices as required.
7. Concentrated reinforcement is to be placed in accordance with Bar Placement Detail.
8. Horizontal reinforcement in shear walls where  $S_{a,ICF} > 0.16$  must be anchored using a standard 180° hook around vertical end bars.
9. When using this table for  $S_{a,ICF} \leq 0.16$ , use the vertical and horizontal distributed steel in Tables A.2.1. or A.2.2.

INSULATING CONCRETE FORMS MANUFACTURERS ASSOCIATION

**Table A.7.800. Above Grade Shear Wall Length for Seismic Zone Classification,  $S_{a,ICF} \leq 0.16$  and Hourly Wind Pressure,  $q_{1/50} \leq 0.5kPa$  (in a Building With Walk Basement), where Building Area  $\leq 800ft^2$**

Wall Height m (ft)	Seismic Zone Classification																	
	$S_{a,ICF} \leq 0.07$		$S_{a,ICF} \leq 0.11$		$S_{a,ICF} \leq 0.16$													
<b>Second Floor Walls of Two Story ICF Structure Supporting Wood Frame Roof (TYPE E)</b>																		
	6" & 8" Thick Wall		10" & 12" Thick Wall		6" & 8" Thick Wall		10" & 12" Thick Wall											
	Number and length of shear walls provided																	
2.44 (8)	1 x 5'-2"	2 x 2'-8"	--	1 x 5'-2"	2 x 2'-8"	--	1 x 5'-2"	2 x 2'-8"	--	1 x 5'-2"	2 x 2'-11"	3 x 2'-8"	1 x 5'-2"	2 x 3'-3"	3 x 2'-8"			
2.75 (9)	1 x 5'-2"	2 x 2'-8"	--	1 x 5'-2"	2 x 2'-8"	--	1 x 5'-2"	2 x 2'-8"	--	1 x 5'-2"	2 x 2'-10"	3 x 2'-8"	1 x 5'-6"	2 x 3'-6"	3 x 2'-10"			
3.05 (10)	1 x 5'-2"	2 x 2'-8"	--	1 x 5'-2"	2 x 2'-8"	--	1 x 5'-2"	2 x 2'-11"	3 x 2'-8"	1 x 5'-2"	2 x 3'-7"	3 x 2'-10"	1 x 6'-2"	2 x 3'-8"	3 x 2'-10"			
3.66 (12)	1 x 5'-2"	2 x 2'-8"	--	1 x 5'-2"	2 x 2'-8"	--	1 x 5'-6"	2 x 3'-7"	3 x 2'-10"	1 x 5'-6"	2 x 3'-7"	3 x 2'-10"	1 x 6'-10"	2 x 4'-7"	3 x 3'-7"			
4.27 (14)	1 x 5'-2"	2 x 2'-11"	3 x 2'-8"	1 x 5'-2"	2 x 3'-3"	3 x 2'-8"	1 x 6'-6"	2 x 3'-11"	3 x 3'-0"	1 x 6'-10"	2 x 4'-7"	3 x 3'-6"	1 x 7'-6"	2 x 4'-11"	3 x 3'-11"			
4.88 (16)	1 x 5'-2"	2 x 3'-3"	3 x 2'-8"	1 x 5'-10"	2 x 3'-7"	3 x 2'-11"	1 x 6'-6"	2 x 4'-3"	3 x 3'-3"	1 x 7'-2"	2 x 4'-11"	3 x 3'-8"	1 x 7'-10"	2 x 5'-2"	3 x 4'-3"			
<b>Main Floor Walls of One Story ICF Structure Supporting Wood Frame Roof (TYPE F)</b>																		
	6" & 8" Thick Wall		10" & 12" Thick Wall		6" & 8" Thick Wall		10" & 12" Thick Wall											
	Number and length of shear walls provided																	
2.44 (8)	1 x 5'-2"	2 x 2'-8"	--	1 x 5'-2"	2 x 2'-8"	--	1 x 5'-2"	2 x 2'-8"	--	1 x 5'-2"	2 x 2'-8"	--	1 x 5'-2"	2 x 2'-11"	3 x 2'-8"			
2.75 (9)	1 x 5'-2"	2 x 2'-8"	--	1 x 5'-2"	2 x 2'-8"	--	1 x 5'-2"	2 x 2'-8"	--	1 x 5'-2"	2 x 2'-11"	3 x 2'-8"	1 x 5'-6"	2 x 3'-3"	3 x 2'-8"			
3.05 (10)	1 x 5'-2"	2 x 2'-8"	--	1 x 5'-2"	2 x 2'-8"	--	1 x 5'-2"	2 x 2'-11"	3 x 2'-8"	1 x 5'-2"	2 x 3'-7"	3 x 2'-10"	1 x 6'-2"	2 x 3'-8"	3 x 2'-10"			
3.66 (12)	1 x 5'-2"	2 x 2'-8"	--	1 x 5'-2"	2 x 2'-8"	--	1 x 5'-6"	2 x 3'-7"	3 x 2'-10"	1 x 5'-6"	2 x 3'-7"	3 x 2'-10"	1 x 6'-10"	2 x 4'-7"	3 x 3'-7"			
4.27 (14)	1 x 5'-2"	2 x 2'-11"	3 x 2'-8"	1 x 5'-2"	2 x 3'-3"	3 x 2'-8"	1 x 6'-6"	2 x 3'-11"	3 x 3'-0"	1 x 6'-10"	2 x 4'-7"	3 x 3'-6"	1 x 7'-6"	2 x 4'-11"	3 x 3'-11"			
4.88 (16)	1 x 5'-2"	2 x 3'-3"	3 x 2'-8"	1 x 5'-10"	2 x 3'-7"	3 x 2'-11"	1 x 6'-6"	2 x 4'-3"	3 x 3'-3"	1 x 7'-2"	2 x 4'-11"	3 x 3'-8"	1 x 7'-10"	2 x 5'-2"	3 x 4'-3"			
<b>Main Floor Walls of Two Story Structure Supporting 2nd Story Wood Framed Walls, Floor and Roof (TYPE G)</b>																		
	6" & 8" Thick Wall		10" & 12" Thick Wall		6" & 8" Thick Wall		10" & 12" Thick Wall											
	Number and length of shear walls provided																	
2.44 (8)	1 x 5'-2"	2 x 3'-3"	3 x 2'-8"	1 x 5'-2"	2 x 3'-3"	3 x 2'-8"	1 x 6'-6"	2 x 3'-11"	3 x 3'-3"	1 x 6'-6"	2 x 4'-3"	3 x 3'-3"	1 x 8'-2"	2 x 5'-2"	3 x 3'-11"	1 x 8'-5"	2 x 5'-2"	3 x 4'-3"
2.75 (9)	1 x 5'-2"	2 x 3'-3"	3 x 2'-8"	1 x 5'-2"	2 x 3'-3"	3 x 2'-8"	1 x 6'-10"	2 x 4'-3"	3 x 3'-3"	1 x 7'-2"	2 x 4'-7"	3 x 3'-3"	1 x 8'-9"	2 x 5'-6"	3 x 4'-3"	1 x 8'-11"	2 x 5'-10"	3 x 4'-7"
3.05 (10)	1 x 5'-6"	2 x 3'-7"	3 x 2'-10"	1 x 5'-6"	2 x 3'-7"	3 x 2'-10"	1 x 7'-6"	2 x 4'-9"	3 x 3'-11"	1 x 7'-6"	2 x 4'-9"	3 x 3'-11"	1 x 9'-1"	2 x 5'-10"	3 x 4'-7"	1 x 9'-5"	2 x 6'-1"	3 x 4'-9"
3.66 (12)	1 x 6'-1"	2 x 4'-1"	3 x 3'-3"	1 x 6'-1"	2 x 4'-1"	3 x 3'-3"	1 x 8'-0"	2 x 5'-5"	3 x 4'-3"	1 x 8'-0"	2 x 5'-5"	3 x 4'-3"	1 x 9'-9"	2 x 6'-9"	3 x 5'-2"	1 x 9'-9"	2 x 6'-9"	3 x 5'-2"
4.27 (14)	1 x 6'-3"	2 x 4'-3"	3 x 3'-6"	1 x 6'-9"	2 x 4'-7"	3 x 3'-6"	1 x 8'-3"	2 x 5'-6"	3 x 4'-7"	1 x 8'-9"	2 x 5'-10"	3 x 4'-7"	1 x 10'-1"	2 x 6'-10"	3 x 5'-6"	1 x 10'-7"	2 x 7'-4"	3 x 5'-10"
4.88 (16)	1 x 6'-6"	2 x 4'-7"	3 x 3'-7"	1 x 7'-2"	2 x 4'-9"	3 x 3'-8"	1 x 8'-5"	2 x 5'-10"	3 x 4'-11"	1 x 9'-1"	2 x 6'-2"	3 x 4'-11"	1 x 10'-1"	2 x 6'-10"	3 x 5'-6"	1 x 11'-1"	2 x 7'-6"	3 x 6'-1"
<b>Main Floor Walls of Two Story ICF Structure Supporting Wood Frame Floors and Roof (TYPE H)</b>																		
	6" & 8" Thick Wall		10" & 12" Thick Wall		6" & 8" Thick Wall		10" & 12" Thick Wall											
	Number and length of shear walls provided																	
2.44 (8)	1 x 6'-1"	2 x 3'-11"	3 x 2'-11"	1 x 6'-6"	2 x 4'-1"	3 x 3'-3"	1 x 8'-2"	2 x 5'-2"	3 x 3'-11"	1 x 8'-8"	2 x 5'-6"	3 x 4'-3"	1 x 10'-5"	2 x 6'-6"	3 x 5'-2"	1 x 10'-9"	2 x 7'-2"	3 x 5'-6"
2.75 (9)	1 x 6'-3"	2 x 4'-3"	3 x 3'-0"	1 x 7'-2"	2 x 4'-3"	3 x 3'-3"	1 x 8'-5"	2 x 5'-5"	3 x 4'-3"	1 x 9'-1"	2 x 5'-10"	3 x 4'-7"	1 x 10'-9"	2 x 7'-2"	3 x 5'-6"	1 x 11'-5"	2 x 7'-6"	3 x 5'-10"
3.05 (10)	1 x 6'-9"	2 x 4'-3"	3 x 3'-3"	1 x 7'-2"	2 x 4'-7"	3 x 3'-7"	1 x 8'-11"	2 x 5'-10"	3 x 4'-7"	1 x 9'-9"	2 x 6'-2"	3 x 4'-11"	1 x 11'-5"	2 x 7'-6"	3 x 5'-10"	1 x 12'-0"	2 x 7'-10"	3 x 6'-2"
3.66 (12)	1 x 7'-6"	2 x 4'-11"	3 x 3'-11"	1 x 7'-6"	2 x 4'-11"	3 x 3'-11"	1 x 9'-5"	2 x 6'-6"	3 x 4'-12"	1 x 9'-9"	2 x 6'-6"	3 x 4'-12"	1 x 11'-8"	2 x 8'-0"	3 x 6'-3"	1 x 12'-4"	2 x 8'-0"	3 x 6'-3"
4.27 (14)	1 x 7'-6"	2 x 5'-2"	3 x 4'-3"	1 x 8'-2"	2 x 5'-6"	3 x 4'-7"	1 x 9'-9"	2 x 6'-6"	3 x 5'-2"	1 x 10'-9"	2 x 7'-2"	3 x 5'-10"	1 x 11'-11"	2 x 8'-2"	3 x 6'-6"	1 x 13'-8"	2 x 8'-9"	3 x 7'-2"
4.88 (16)	1 x 7'-6"	2 x 5'-2"	3 x 4'-3"	1 x 8'-5"	2 x 5'-10"	3 x 4'-7"	1 x 9'-9"	2 x 6'-6"	3 x 5'-2"	1 x 11'-5"	2 x 7'-10"	3 x 5'-10"	1 x 11'-11"	2 x 8'-2"	3 x 6'-6"	1 x 13'-8"	2 x 9'-4"	3 x 7'-4"
Vertical Reinforcement	ICF with 6" Tie Spacing	As per table A.1.1.				As per table A.1.1.				As per table A.1.1.								
Vertical Reinforcement	ICF with 8" Tie Spacing	As per table A.1.2.				As per table A.1.2.				As per table A.1.2.								
Horizontal Reinforcement	Block Height of 12" and 18"	10 M @ 450 (18)		10 M @ 450 (18)		10 M @ 450 (18)		10 M @ 450 (18)		10 M @ 450 (18)		10 M @ 450 (18)						
Horizontal Reinforcement	Block Height of 16"	10 M @ 400 (16)		10 M @ 400 (16)		10 M @ 400 (16)		10 M @ 400 (16)		10 M @ 400 (16)		10 M @ 400 (16)						

**NOTES:**

1.  $S_{a,ICF}$  is equivalent spectral response acceleration for ICF walls as provided in Appendix A.
2. This table is to be used in conjunction with the "Design Limitations."
3. Provide two layers of the indicated horizontal and vertical distributed steel specified for 300mm (12") walls. Place each layer as shown in the rebar placement drawing.
4. All four sides of the building are to have a minimum number and length of shear walls that conforms to this table.
5. Use Table A.6 for buildings that do not meet the required wall length of this table.
6. Provide 2-15M concentrated reinforcement at each end of shear walls as shown in shear wall detail.
7. All concentrated reinforcement is to be continues to the bottom of the foundation wall. Provide lap splices as required.
8. Concentrated reinforcement is to be placed in accordance with Bar Placement Detail.

INSULATING CONCRETE FORMS MANUFACTURERS ASSOCIATION

**Table A.8.800. Above Grade Shear Wall Length for Seismic Zone Classification,  $S_{a,ICF} \leq 0.16$  and Hourly Wind Pressure,  $0.5kPa < q1/50 \leq 0.75kPa$  (in a Building With Walkout Basement), where Building Area  $\leq 800ft^2$**

Wall Height m (ft)	Seismic Zone Classification																	
	$S_{a,ICF} \leq 0.07$		$S_{a,ICF} \leq 0.11$		$S_{a,ICF} \leq 0.16$													
<b>Second Floor Walls of Two Story ICF Structure Supporting Wood Frame Roof (TYPE E)</b>																		
	6" & 8" Thick Wall		10" & 12" Thick Wall		6" & 8" Thick Wall		10" & 12" Thick Wall											
	Number and length of shear walls provided																	
2.44 (8)	1 x 5'-2"	2 x 2'-8"	--	1 x 5'-2"	2 x 2'-8"	--	1 x 5'-2"	2 x 2'-8"	--	1 x 5'-2"	2 x 2'-8"	--	1 x 5'-2"	2 x 3'-3"	3 x 2'-8"	1 x 5'-2"	2 x 3'-3"	3 x 2'-8"
2.75 (9)	1 x 5'-2"	2 x 2'-8"	--	1 x 5'-2"	2 x 2'-8"	--	1 x 5'-2"	2 x 2'-8"	--	1 x 5'-2"	2 x 2'-10"	3 x 2'-8"	1 x 5'-6"	2 x 3'-6"	3 x 2'-10"	1 x 6'-1"	2 x 3'-7"	3 x 2'-10"
3.05 (10)	1 x 5'-2"	2 x 2'-8"	--	1 x 5'-2"	2 x 2'-8"	--	1 x 5'-2"	2 x 2'-8"	--	1 x 5'-2"	2 x 3'-3"	3 x 2'-8"	1 x 5'-2"	2 x 3'-3"	3 x 2'-8"	1 x 6'-10"	2 x 4'-1"	3 x 3'-3"
<b>Main Floor Walls of One Story ICF Structure Supporting Wood Frame Roof (TYPE F)</b>																		
	6" & 8" Thick Wall		10" & 12" Thick Wall		6" & 8" Thick Wall		10" & 12" Thick Wall											
	Number and length of shear walls provided																	
2.44 (8)	1 x 5'-2"	2 x 2'-8"	--	1 x 5'-2"	2 x 2'-8"	--	1 x 5'-2"	2 x 2'-8"	--	1 x 5'-2"	2 x 2'-11"	3 x 2'-8"	1 x 5'-2"	2 x 2'-11"	3 x 2'-8"	1 x 5'-2"	2 x 3'-3"	3 x 2'-8"
2.75 (9)	1 x 5'-2"	2 x 2'-8"	--	1 x 5'-2"	2 x 2'-8"	--	1 x 5'-2"	2 x 2'-8"	--	1 x 5'-2"	2 x 2'-11"	3 x 2'-8"	1 x 5'-10"	2 x 3'-11"	3 x 2'-11"	1 x 6'-2"	2 x 3'-8"	3 x 2'-10"
3.05 (10)	1 x 5'-2"	2 x 2'-8"	--	1 x 5'-2"	2 x 2'-8"	--	1 x 5'-2"	2 x 2'-11"	3 x 2'-8"	1 x 5'-2"	2 x 2'-11"	3 x 2'-8"	1 x 5'-10"	2 x 3'-11"	3 x 2'-11"	1 x 6'-2"	2 x 3'-8"	3 x 2'-10"
3.66 (12)	1 x 5'-2"	2 x 2'-8"	--	1 x 5'-2"	2 x 2'-10"	3 x 2'-8"	1 x 5'-6"	2 x 3'-7"	3 x 2'-10"	1 x 5'-8"	2 x 3'-8"	3 x 2'-10"	1 x 6'-10"	2 x 4'-7"	3 x 3'-7"	1 x 7'-2"	2 x 4'-7"	3 x 3'-7"
4.27 (14)	1 x 5'-2"	2 x 2'-11"	3 x 2'-8"	1 x 5'-2"	2 x 3'-3"	3 x 2'-8"	1 x 6'-6"	2 x 3'-11"	3 x 3'-0"	1 x 6'-10"	2 x 4'-7"	3 x 3'-6"	1 x 7'-6"	2 x 4'-11"	3 x 3'-11"	1 x 8'-2"	2 x 5'-5"	3 x 4'-3"
4.88 (16)	1 x 5'-2"	2 x 3'-3"	3 x 2'-8"	1 x 5'-10"	2 x 3'-7"	3 x 2'-11"	1 x 6'-6"	2 x 4'-3"	3 x 3'-3"	1 x 7'-2"	2 x 4'-11"	3 x 3'-8"	1 x 7'-10"	2 x 5'-2"	3 x 4'-3"	1 x 9'-1"	2 x 6'-1"	3 x 4'-9"
<b>Main Floor Walls of Two Story Structure Supporting 2nd Story Wood Framed Walls, Floor and Roof (TYPE G)</b>																		
	6" & 8" Thick Wall		10" & 12" Thick Wall		6" & 8" Thick Wall		10" & 12" Thick Wall											
	Number and length of shear walls provided																	
2.44 (8)	1 x 5'-2"	2 x 3'-3"	3 x 2'-8"	1 x 5'-2"	2 x 3'-3"	3 x 2'-8"	1 x 6'-9"	2 x 4'-4"	3 x 3'-6"	1 x 6'-6"	2 x 4'-3"	3 x 3'-3"	1 x 8'-5"	2 x 5'-6"	3 x 4'-3"	1 x 8'-5"	2 x 5'-2"	3 x 4'-3"
2.75 (9)	1 x 5'-2"	2 x 3'-3"	3 x 2'-8"	1 x 5'-2"	2 x 3'-3"	3 x 2'-8"	1 x 6'-10"	2 x 4'-4"	3 x 3'-3"	1 x 7'-2"	2 x 4'-7"	3 x 3'-3"	1 x 8'-9"	2 x 5'-6"	3 x 4'-3"	1 x 8'-11"	2 x 5'-10"	3 x 4'-7"
3.05 (10)	1 x 5'-8"	2 x 3'-8"	3 x 2'-10"	1 x 5'-6"	2 x 3'-7"	3 x 2'-10"	1 x 7'-6"	2 x 4'-11"	3 x 3'-11"	1 x 7'-6"	2 x 4'-9"	3 x 3'-11"	1 x 9'-4"	2 x 6'-2"	3 x 4'-9"	1 x 9'-5"	2 x 6'-1"	3 x 4'-9"
3.66 (12)	1 x 6'-1"	2 x 4'-1"	3 x 3'-3"	1 x 6'-1"	2 x 4'-1"	3 x 3'-3"	1 x 8'-0"	2 x 5'-5"	3 x 4'-3"	1 x 8'-0"	2 x 5'-5"	3 x 4'-3"	1 x 9'-9"	2 x 6'-9"	3 x 5'-2"	1 x 9'-9"	2 x 6'-9"	3 x 5'-2"
4.27 (14)	1 x 6'-3"	2 x 4'-3"	3 x 3'-6"	1 x 6'-9"	2 x 4'-7"	3 x 3'-6"	1 x 8'-3"	2 x 5'-6"	3 x 4'-7"	1 x 8'-9"	2 x 5'-10"	3 x 4'-7"	1 x 10'-1"	2 x 6'-10"	3 x 5'-6"	1 x 10'-7"	2 x 7'-4"	3 x 5'-10"
4.88 (16)	1 x 6'-6"	2 x 4'-7"	3 x 3'-7"	1 x 7'-2"	2 x 4'-9"	3 x 3'-8"	1 x 8'-5"	2 x 5'-10"	3 x 4'-11"	1 x 9'-1"	2 x 6'-2"	3 x 4'-11"	1 x 10'-1"	2 x 6'-10"	3 x 5'-6"	1 x 11'-1"	2 x 7'-6"	3 x 6'-1"
<b>Main Floor Walls of Two Story ICF Structure Supporting Wood Frame Floors and Roof (TYPE H)</b>																		
	6" & 8" Thick Wall		10" & 12" Thick Wall		6" & 8" Thick Wall		10" & 12" Thick Wall											
	Number and length of shear walls provided																	
2.44 (8)	1 x 6'-1"	2 x 3'-11"	3 x 3'-0"	1 x 6'-6"	2 x 4'-1"	3 x 3'-3"	1 x 8'-2"	2 x 5'-2"	3 x 4'-1"	1 x 8'-8"	2 x 5'-6"	3 x 4'-3"	1 x 10'-5"	2 x 6'-6"	3 x 5'-2"	1 x 10'-9"	2 x 7'-2"	3 x 5'-6"
2.75 (9)	1 x 6'-3"	2 x 4'-3"	3 x 3'-0"	1 x 7'-2"	2 x 4'-3"	3 x 3'-3"	1 x 8'-5"	2 x 5'-5"	3 x 4'-3"	1 x 9'-1"	2 x 5'-10"	3 x 4'-7"	1 x 10'-9"	2 x 7'-2"	3 x 5'-6"	1 x 11'-5"	2 x 7'-6"	3 x 5'-10"
3.05 (10)	1 x 7'-2"	2 x 4'-7"	3 x 3'-7"	1 x 7'-2"	2 x 4'-7"	3 x 3'-7"	1 x 9'-1"	2 x 6'-2"	3 x 4'-9"	1 x 9'-9"	2 x 6'-2"	3 x 4'-11"	1 x 11'-5"	2 x 7'-6"	3 x 5'-10"	1 x 12'-0"	2 x 7'-10"	3 x 6'-2"
3.66 (12)	1 x 7'-6"	2 x 4'-11"	3 x 3'-11"	1 x 7'-6"	2 x 4'-12"	3 x 3'-11"	1 x 9'-5"	2 x 6'-6"	3 x 4'-12"	1 x 9'-9"	2 x 6'-6"	3 x 5'-2"	1 x 11'-8"	2 x 8'-0"	3 x 6'-3"	1 x 12'-4"	2 x 8'-2"	3 x 6'-6"
4.27 (14)	1 x 7'-6"	2 x 5'-2"	3 x 4'-3"	1 x 8'-2"	2 x 5'-6"	3 x 4'-7"	1 x 9'-9"	2 x 6'-6"	3 x 5'-2"	1 x 10'-9"	2 x 7'-2"	3 x 5'-10"	1 x 11'-11"	2 x 8'-2"	3 x 6'-6"	1 x 13'-8"	2 x 8'-9"	3 x 7'-2"
4.88 (16)	1 x 7'-6"	2 x 5'-2"	3 x 4'-3"	1 x 8'-5"	2 x 5'-10"	3 x 4'-7"	1 x 9'-9"	2 x 6'-6"	3 x 5'-2"	1 x 11'-5"	2 x 7'-10"	3 x 5'-10"	1 x 11'-11"	2 x 8'-2"	3 x 6'-6"	1 x 13'-8"	2 x 9'-4"	3 x 7'-4"
Vertical Reinforcement	ICF with 6" Tie Spacing		As per table A.1.1.				As per table A.1.1.				As per table A.1.1.							
Vertical Reinforcement	ICF with 8" Tie Spacing		As per table A.1.2.				As per table A.1.2.				As per table A.1.2.							
Horizontal Reinforcement	Block Height of 12" and 18"		10 M @ 450 (18)		10 M @ 450 (18)		10 M @ 450 (18)		10 M @ 450 (18)		10 M @ 450 (18)		10 M @ 450 (18)					
Horizontal Reinforcement	Block Height of 16"		10 M @ 400 (16)		10 M @ 400 (16)		10 M @ 400 (16)		10 M @ 400 (16)		10 M @ 400 (16)		10 M @ 400 (16)					

**NOTES:**

1.  $S_{a,ICF}$  is equivalent spectral response acceleration for ICF walls as provided in Appendix A.
2. This table is to be used in conjunction with the "Design Limitations."
3. Provide two layers of the indicated horizontal and vertical distributed steel specified for 300mm (12") walls. Place each layer as shown in the rebar placement drawing.
4. All four sides of the building are to have a minimum number and length of shear walls that conforms to this table.
5. Use Table A.6 for buildings that do not meet the required wall length of this table.
6. Provide 2-15M concentrated reinforcement at each end of shear walls as shown in shear wall detail.
7. All concentrated reinforcement is to be continues to the bottom of the foundation wall. Provide lap splices as required.
8. Concentrated reinforcement is to be placed in accordance with Bar Placement Detail.

INSULATING CONCRETE FORMS MANUFACTURERS ASSOCIATION

**Table A.9.800. Above Grade Shear Wall Length for Seismic Zone Classification,  $S_{a,ICF} \leq 0.16$  and Hourly Wind Pressure,  $0.75kPa < q_{1/50} \leq 1.05kPa$  (in a Building With Walkout Basement), where Building Area  $\leq 800ft^2$**

Wall Height m (ft)	Seismic Zone Classification					
	$S_{a,ICF} \leq 0.07$		$S_{a,ICF} \leq 0.11$		$S_{a,ICF} \leq 0.16$	
<b>Second Floor Walls of Two Story ICF Structure Supporting Wood Frame Roof (TYPE E)</b>						
	6" & 8" Thick Wall		10" & 12" Thick Wall		6" & 8" Thick Wall	
	Number and length of shear walls provided					
2.44 (8)	1 x 5'-2"	2 x 2'-8"	--	1 x 5'-2"	2 x 2'-8"	--
2.75 (9)	1 x 5'-2"	2 x 2'-8"	--	1 x 5'-2"	2 x 2'-8"	--
3.05 (10)	1 x 5'-2"	2 x 2'-8"	--	1 x 5'-2"	2 x 2'-8"	--
3.66 (12)	1 x 5'-2"	2 x 2'-8"	--	1 x 5'-2"	2 x 2'-8"	--
4.27 (14)	1 x 5'-2"	2 x 2'-11"	3 x 2'-8"	1 x 5'-2"	2 x 3'-3"	3 x 2'-8"
4.88 (16)	1 x 5'-2"	2 x 3'-3"	3 x 2'-8"	1 x 5'-2"	2 x 3'-3"	3 x 2'-8"
<b>Main Floor Walls of One Story ICF Structure Supporting Wood Frame Roof (TYPE F)</b>						
	6" & 8" Thick Wall		10" & 12" Thick Wall		6" & 8" Thick Wall	
	Number and length of shear walls provided					
2.44 (8)	1 x 5'-2"	2 x 2'-8"	--	1 x 5'-2"	2 x 2'-8"	--
2.75 (9)	1 x 5'-2"	2 x 2'-8"	--	1 x 5'-2"	2 x 2'-8"	--
3.05 (10)	1 x 5'-2"	2 x 2'-8"	--	1 x 5'-2"	2 x 2'-8"	--
3.66 (12)	1 x 5'-2"	2 x 2'-8"	--	1 x 5'-2"	2 x 2'-8"	--
4.27 (14)	1 x 5'-2"	2 x 2'-11"	3 x 2'-8"	1 x 5'-2"	2 x 3'-3"	3 x 2'-8"
4.88 (16)	1 x 5'-2"	2 x 3'-3"	3 x 2'-8"	1 x 5'-2"	2 x 3'-3"	3 x 2'-8"
<b>Main Floor Walls of Two Story Structure Supporting 2nd Story Wood Framed Walls, Floor and Roof (TYPE G)</b>						
	6" & 8" Thick Wall		10" & 12" Thick Wall		6" & 8" Thick Wall	
	Number and length of shear walls provided					
2.44 (8)	1 x 5'-2"	2 x 3'-3"	3 x 2'-8"	1 x 5'-2"	2 x 3'-3"	3 x 2'-8"
2.75 (9)	1 x 5'-2"	2 x 3'-3"	3 x 2'-8"	1 x 5'-2"	2 x 3'-3"	3 x 2'-8"
3.05 (10)	1 x 5'-2"	2 x 3'-3"	3 x 2'-8"	1 x 5'-2"	2 x 3'-3"	3 x 2'-8"
3.66 (12)	1 x 5'-2"	2 x 3'-3"	3 x 2'-8"	1 x 5'-2"	2 x 3'-3"	3 x 2'-8"
4.27 (14)	1 x 5'-2"	2 x 4'-1"	3 x 3'-3"	1 x 5'-2"	2 x 4'-1"	3 x 3'-3"
4.88 (16)	1 x 5'-2"	2 x 4'-7"	3 x 3'-7"	1 x 5'-2"	2 x 4'-7"	3 x 3'-7"
<b>Main Floor Walls of Two Story ICF Structure Supporting Wood Frame Floors and Roof (TYPE H)</b>						
	6" & 8" Thick Wall		10" & 12" Thick Wall		6" & 8" Thick Wall	
	Number and length of shear walls provided					
2.44 (8)	1 x 6'-1"	2 x 3'-11"	3 x 3'-0"	1 x 6'-1"	2 x 4'-1"	3 x 3'-3"
2.75 (9)	1 x 6'-1"	2 x 4'-3"	3 x 3'-0"	1 x 6'-1"	2 x 4'-7"	3 x 3'-6"
3.05 (10)	1 x 6'-1"	2 x 4'-7"	3 x 3'-7"	1 x 6'-1"	2 x 4'-7"	3 x 3'-7"
3.66 (12)	1 x 6'-1"	2 x 4'-11"	3 x 3'-11"	1 x 6'-1"	2 x 4'-11"	3 x 3'-11"
4.27 (14)	1 x 6'-1"	2 x 5'-2"	3 x 4'-3"	1 x 6'-1"	2 x 5'-5"	3 x 4'-3"
4.88 (16)	1 x 6'-1"	2 x 5'-2"	3 x 4'-3"	1 x 6'-1"	2 x 5'-5"	3 x 4'-3"
Vertical Reinforcement	ICF with 6" Tie Spacing	As per table A.1.1.			As per table A.1.1.	
Vertical Reinforcement	ICF with 8" Tie Spacing	As per table A.1.2.			As per table A.1.2.	
Horizontal Reinforcement	Block Height of 12" and 18"	10 M @ 450 (18)		10 M @ 450 (18)		
Horizontal Reinforcement	Block Height of 16"	10 M @ 400 (16)		10 M @ 400 (16)		

**NOTES:**

1.  $S_{a,ICF}$  is equivalent spectral response acceleration for ICF walls as provided in Appendix A.
2. This table is to be used in conjunction with the "Design Limitations."
3. Provide two layers of the indicated horizontal and vertical distributed steel specified for 300mm (12") walls. Place each layer as shown in the rebar placement drawing.
4. All four sides of the building are to have a minimum number and length of shear walls that conforms to this table.
5. Use Table A.6 for buildings that do not meet the required wall length of this table.
6. Provide 2-15M concentrated reinforcement at each end of shear walls as shown in shear wall detail.
7. All concentrated reinforcement is to be continues to the bottom of the foundation wall. Provide lap splices as required.
8. Concentrated reinforcement is to be placed in accordance with Bar Placement Detail.

INSULATING CONCRETE FORMS MANUFACTURERS ASSOCIATION

**Table A.10.800. Above Grade Shear Wall Length for Seismic Zone Classification,  $S_{a,ICF} > 0.16$  and Hourly Wind Pressure,  $q_{1/50} \leq 1.05kPa$  (in a Building With Walkout Basement), where Building Area  $\leq 800ft^2$**

Wall Height m (ft)	Seismic Zone Classification							
	$S_{a,ICF} \leq 0.16$		$S_{a,ICF} \leq 0.31$		$S_{a,ICF} \leq 0.53$		$S_{a,ICF} \leq 0.79$	
<b>Second Floor Walls of Two Story ICF Structure Supporting Wood Frame Roof (TYPE E)</b>								
	6" & 8" Thick Wall	10" & 12" Thick Wall	6" & 8" Thick Wall	10" & 12" Thick Wall	6" & 8" Thick Wall	10" & 12" Thick Wall	6" & 8" Thick Wall	10" & 12" Thick Wall
	Number and length of shear walls provided							
2.44 (8)	1x5'-2" 2x2'-8"	1x5'-2" 2x2'-8"	1x5'-10" 2x4'-0"	1x5'-10" 2x4'-0"	1x7'-2" 2x4'-11"	1x7'-6" 2x5'-2"	1x8'-2" 2x5'-6"	1x8'-2" 2x5'-10"
2.75 (9)	1x5'-2" 2x2'-11"	1x5'-2" 2x2'-11"	1x6'-6" 2x4'-7"	1x6'-6" 2x4'-7"	1x8'-2" 2x5'-6"	1x8'-2" 2x5'-10"	1x8'-9" 2x6'-2"	1x9'-1" 2x6'-6"
3.05 (10)	1x5'-2" 2x3'-3"	1x5'-2" 2x3'-3"	1x7'-2" 2x5'-0"	1x7'-6" 2x5'-0"	1x8'-9" 2x6'-2"	1x9'-1" 2x6'-2"	1x9'-9" 2x6'-10"	1x10'-1" 2x6'-10"
3.05 (10)	1x5'-2" 2x2'-8"	1x5'-2" 2x2'-8"	1x5'-10" 2x4'-0"	1x5'-10" 2x4'-0"	1x7'-2" 2x4'-11"	1x7'-6" 2x5'-2"	1x8'-2" 2x5'-6"	1x8'-2" 2x5'-10"
3.05 (10)	1x5'-2" 2x2'-11"	1x5'-2" 2x2'-11"	1x6'-6" 2x4'-7"	1x6'-6" 2x4'-7"	1x8'-2" 2x5'-6"	1x8'-2" 2x5'-10"	1x8'-9" 2x6'-2"	1x9'-1" 2x6'-6"
3.05 (10)	1x5'-2" 2x3'-3"	1x5'-2" 2x3'-3"	1x7'-2" 2x5'-0"	1x7'-6" 2x5'-0"	1x8'-9" 2x6'-2"	1x9'-1" 2x6'-2"	1x9'-9" 2x6'-10"	1x10'-1" 2x6'-10"
4.27 (14)	1x5'-10" 2x4'-1"	1x5'-10" 2x4'-1"	1x6'-2" 2x4'-3"	1x6'-2" 2x4'-3"	1x8'-5" 2x7'-0"	1x8'-5" 2x7'-0"	1x11'-8" 2x8'-2"	1x11'-8" 2x8'-2"
4.88 (16)	1x6'-2" 2x4'-3"	1x6'-2" 2x4'-3"	1x8'-9" 2x6'-0"	1x8'-9" 2x6'-0"	1x12'-4" 2x8'-2"	1x12'-4" 2x8'-2"	1x14'-11" 2x10'-5"	1x14'-11" 2x10'-5"
<b>Main Floor Walls of One Story ICF Structure Supporting Wood Frame Roof (TYPE F)</b>								
	6" & 8" Thick Wall	10" & 12" Thick Wall	6" & 8" Thick Wall	10" & 12" Thick Wall	6" & 8" Thick Wall	10" & 12" Thick Wall	6" & 8" Thick Wall	10" & 12" Thick Wall
	Number and length of shear walls provided							
2.44 (8)	1x5'-2" 2x2'-8"	1x5'-2" 2x2'-8"	1x5'-10" 2x4'-0"	1x5'-10" 2x4'-0"	1x7'-2" 2x4'-11"	1x7'-6" 2x5'-2"	1x8'-2" 2x5'-6"	1x8'-2" 2x5'-10"
2.75 (9)	1x5'-2" 2x2'-11"	1x5'-2" 2x2'-11"	1x6'-6" 2x4'-7"	1x6'-6" 2x4'-7"	1x8'-2" 2x5'-6"	1x8'-2" 2x5'-10"	1x8'-9" 2x6'-2"	1x9'-1" 2x6'-6"
3.05 (10)	1x5'-2" 2x3'-3"	1x5'-2" 2x3'-3"	1x7'-2" 2x5'-0"	1x7'-6" 2x5'-0"	1x8'-9" 2x6'-2"	1x9'-1" 2x6'-2"	1x9'-9" 2x6'-10"	1x10'-1" 2x6'-10"
3.05 (10)	1x5'-2" 2x2'-8"	1x5'-2" 2x2'-8"	1x5'-10" 2x4'-0"	1x5'-10" 2x4'-0"	1x7'-2" 2x4'-11"	1x7'-6" 2x5'-2"	1x8'-2" 2x5'-6"	1x8'-2" 2x5'-10"
3.05 (10)	1x5'-2" 2x2'-11"	1x5'-2" 2x2'-11"	1x6'-6" 2x4'-7"	1x6'-6" 2x4'-7"	1x8'-2" 2x5'-6"	1x8'-2" 2x5'-10"	1x8'-9" 2x6'-2"	1x9'-1" 2x6'-6"
3.05 (10)	1x5'-2" 2x3'-3"	1x5'-2" 2x3'-3"	1x7'-2" 2x5'-0"	1x7'-6" 2x5'-0"	1x8'-9" 2x6'-2"	1x9'-1" 2x6'-2"	1x9'-9" 2x6'-10"	1x10'-1" 2x6'-10"
4.27 (14)	1x5'-10" 2x4'-1"	1x5'-10" 2x4'-1"	1x6'-2" 2x4'-3"	1x6'-2" 2x4'-3"	1x8'-5" 2x7'-0"	1x8'-5" 2x7'-0"	1x11'-8" 2x8'-2"	1x11'-8" 2x8'-2"
4.88 (16)	1x6'-2" 2x4'-3"	1x6'-2" 2x4'-3"	1x8'-9" 2x6'-0"	1x8'-9" 2x6'-0"	1x12'-4" 2x8'-2"	1x12'-4" 2x8'-2"	1x14'-11" 2x10'-5"	1x14'-11" 2x10'-5"
<b>Main Floor Walls of Two Story Structure Supporting 2nd Story Wood Framed Walls, Floor and Roof (TYPE G)</b>								
	6" & 8" Thick Wall	10" & 12" Thick Wall	6" & 8" Thick Wall	10" & 12" Thick Wall	6" & 8" Thick Wall	10" & 12" Thick Wall	6" & 8" Thick Wall	10" & 12" Thick Wall
	Number and length of shear walls provided							
2.44 (8)	1x6'-6" 2x4'-3"	1x6'-6" 2x4'-3"	1x9'-1" 2x6'-2"	1x9'-1" 2x6'-2"	1x12'-4" 2x8'-5"	1x12'-4" 2x8'-5"	1x13'-0" 2x9'-1"	1x13'-0" 2x9'-1"
2.75 (9)	1x7'-2" 2x4'-7"	1x7'-2" 2x4'-7"	1x9'-9" 2x6'-6"	1x9'-9" 2x6'-6"	1x13'-4" 2x9'-1"	1x13'-4" 2x9'-1"	1x13'-0" 2x9'-1"	1x13'-0" 2x9'-1"
3.05 (10)	1x7'-2" 2x4'-11"	1x7'-2" 2x4'-11"	1x10'-5" 2x7'-2"	1x10'-5" 2x7'-2"	1x13'-12" 2x9'-5"	1x13'-12" 2x9'-5"	1x14'-4" 2x9'-9"	1x14'-4" 2x9'-9"
3.05 (10)	1x7'-6" 2x5'-2"	1x7'-6" 2x5'-2"	1x10'-5" 2x7'-6"	1x10'-5" 2x7'-6"	1x13'-12" 2x9'-9"	1x13'-12" 2x9'-9"	1x15'-7" 2x10'-9"	1x15'-7" 2x10'-9"
3.05 (10)	1x8'-2" 2x5'-6"	1x8'-2" 2x5'-6"	1x11'-5" 2x7'-10"	1x11'-5" 2x7'-10"	1x15'-7" 2x10'-9"	1x15'-7" 2x10'-9"	1x16'-11" 2x11'-8"	1x16'-11" 2x11'-8"
3.05 (10)	1x8'-2" 2x5'-10"	1x8'-2" 2x5'-10"	1x11'-5" 2x8'-0"	1x11'-5" 2x8'-0"	1x15'-7" 2x10'-9"	1x15'-7" 2x10'-9"	1x16'-11" 2x11'-8"	1x16'-11" 2x11'-8"
4.27 (14)	1x8'-2" 2x5'-6"	1x8'-2" 2x5'-6"	1x11'-5" 2x7'-10"	1x11'-5" 2x7'-10"	1x15'-7" 2x10'-9"	1x15'-7" 2x10'-9"	1x16'-11" 2x11'-8"	1x16'-11" 2x11'-8"
4.88 (16)	1x8'-2" 2x5'-10"	1x8'-2" 2x5'-10"	1x11'-5" 2x8'-0"	1x11'-5" 2x8'-0"	1x15'-7" 2x10'-9"	1x15'-7" 2x10'-9"	1x16'-11" 2x11'-8"	1x16'-11" 2x11'-8"
<b>Main Floor Walls of Two Story ICF Structure Supporting Wood Frame Floors and Roof (TYPE H)</b>								
	6" & 8" Thick Wall	10" & 12" Thick Wall	6" & 8" Thick Wall	10" & 12" Thick Wall	6" & 8" Thick Wall	10" & 12" Thick Wall	6" & 8" Thick Wall	10" & 12" Thick Wall
	Number and length of shear walls provided							
2.44 (8)	1x7'-10" 2x5'-2"	1x7'-10" 2x5'-2"	1x11'-1" 2x7'-10"	1x11'-1" 2x7'-10"	1x13'-8" 2x9'-9"	1x13'-8" 2x9'-9"	1x14'-4" 2x9'-9"	1x14'-4" 2x9'-9"
2.75 (9)	1x8'-5" 2x5'-10"	1x8'-5" 2x5'-10"	1x11'-8" 2x8'-5"	1x11'-8" 2x8'-5"	1x14'-4" 2x9'-9"	1x14'-4" 2x9'-9"	1x15'-7" 2x10'-5"	1x15'-7" 2x10'-5"
3.05 (10)	1x9'-1" 2x5'-10"	1x9'-1" 2x5'-10"	1x12'-4" 2x8'-5"	1x12'-4" 2x8'-5"	1x14'-11" 2x10'-5"	1x14'-11" 2x10'-5"	1x16'-11" 2x11'-8"	1x16'-11" 2x11'-8"
3.05 (10)	1x9'-1" 2x6'-2"	1x9'-1" 2x6'-2"	1x13'-0" 2x8'-5"	1x13'-0" 2x8'-5"	1x16'-3" 2x11'-8"	1x16'-3" 2x11'-8"	1x18'-2" 2x13'-0"	1x18'-2" 2x13'-0"
3.05 (10)	1x9'-1" 2x6'-6"	1x9'-1" 2x6'-6"	1x13'-8" 2x9'-9"	1x13'-8" 2x9'-9"	1x16'-3" 2x11'-8"	1x16'-3" 2x11'-8"	1x18'-2" 2x13'-0"	1x18'-2" 2x13'-0"
4.27 (14)	1x9'-9" 2x6'-6"	1x9'-9" 2x6'-6"	1x14'-11" 2x10'-5"	1x14'-11" 2x10'-5"	1x18'-2" 2x12'-4"	1x18'-2" 2x12'-4"	1x20'-2" 2x13'-8"	1x20'-2" 2x13'-8"
4.88 (16)	1x9'-9" 2x6'-6"	1x9'-9" 2x6'-6"	1x14'-11" 2x10'-5"	1x14'-11" 2x10'-5"	1x18'-2" 2x12'-4"	1x18'-2" 2x12'-4"	1x20'-2" 2x13'-8"	1x20'-2" 2x13'-8"
<b>Vertical Reinforcement</b>								
	ICF with 6" Tie Spacing	As per table A.2.1	As per table A.2.1	As per table A.2.1	As per table A.2.1	As per table A.2.1	As per table A.2.1	As per table A.2.1
	ICF with 8" Tie Spacing	As per table A.2.2	As per table A.2.2	As per table A.2.2	As per table A.2.2	As per table A.2.2	As per table A.2.2	As per table A.2.2
<b>Horizontal Reinforcement</b>								
	Block Height of 12" and 18"	As per table A.2.1	As per table A.2.1	As per table A.2.1	As per table A.2.1	As per table A.2.1	As per table A.2.1	As per table A.2.1
	Block Height of 10"	As per table A.2.2	As per table A.2.2	As per table A.2.2	As per table A.2.2	As per table A.2.2	As per table A.2.2	As per table A.2.2

**NOTES:**

1.  $S_{a,ICF}$  is equivalent spectral response acceleration for ICF walls as provided in Appendix A.
2. This table is to be used in conjunction with the "Design Limitations."
3. Provide two layers of the indicated horizontal and vertical distributed steel specified for 300mm (12") walls. Place each layer as shown in the rebar placement drawing.
4. All four sides of the building are to have a minimum number and length of shear walls that conforms to this table.
5. Provide 2-15M concentrated reinforcement at each end of shear walls as shown in shear wall detail.
6. All concentrated reinforcement is to be continues to the bottom of the foundation wall. Provide lap splices as required.
7. Concentrated reinforcement is to be placed in accordance with Bar Placement Detail.
8. Horizontal reinforcement in shear walls where  $S_{a,ICF} > 0.16$  must be anchored using a standard 180° hook around vertical end bars.
9. When using this table for  $S_{a,ICF} \leq 0.16$ , use the vertical and horizontal distributed steel in Tables A.2.1, or A.2.2.

**INSULATING CONCRETE FORMS MANUFACTURERS ASSOCIATION**

**Table A. 11.800. – Above Grade Walkout Basement Shear Wall Length for Seismic Zone Classification,  $S_{a,ICF} \leq 0.31$  and Hourly Wind Pressure,  $q/50 \leq 1.05kPa$ , where Building Area  $\leq 800ft^2$**

Wall Height m (ft)	Seismic Zone Classification							
	$S_{a,ICF} \leq 0.07$		$S_{a,ICF} \leq 0.11$		$S_{a,ICF} \leq 0.16$		$S_{a,ICF} \leq 0.31$	
	6" & 8" Thick Wall	10" & 12" Thick Wall	6" & 8" Thick Wall	10" & 12" Thick Wall	6" & 8" Thick Wall	10" & 12" Thick Wall	6" & 8" Thick Wall	10" & 12" Thick Wall
<b>Walkout Basement Wall of a Single Story ICF Structure Supporting Wood Framed Roof (TYPE W1)</b>								
	Number and length of shear walls provided							
2.44 (8)	1x5'-2" 2x3'-7" 3x2'-11"	1x5'-6" 2x3'-11" 3x2'-11"	1x6'-6" 2x4'-7" 3x3'-9"	1x6'-10" 2x4'-11" 3x3'-11"	1x8'-2" 2x5'-6" 3x4'-7"	1x8'-5" 2x5'-10" 3x4'-7"	1x11'-8" 2x7'-10" 3x6'-6"	1x12'-4" 2x8'-5" 3x6'-8"
2.75 (9)	1x5'-4" 2x3'-7" 3x2'-11"	1x5'-10" 2x3'-11" 3x3'-9"	1x6'-10" 2x4'-7" 3x3'-11"	1x7'-2" 2x4'-11" 3x3'-11"	1x8'-2" 2x5'-10" 3x4'-7"	1x8'-8" 2x5'-10" 3x4'-9"	1x11'-8" 2x8'-2" 3x6'-6"	1x12'-4" 2x8'-5" 3x6'-10"
3.05 (10)	1x5'-6" 2x3'-11" 3x2'-11"	1x5'-10" 2x4'-3" 3x3'-9"	1x6'-10" 2x4'-11" 3x3'-11"	1x7'-2" 2x4'-11" 3x3'-11"	1x8'-5" 2x5'-10" 3x4'-11"	1x9'-0" 2x6'-2" 3x4'-11"	1x12'-0" 2x8'-5" 3x6'-10"	1x12'-8" 2x8'-9" 3x7'-2"
3.66 (12)	1x6'-0" 2x4'-0" 3x3'-3"	1x6'-6" 2x4'-3" 3x3'-9"	1x7'-4" 2x5'-2" 3x4'-3"	1x7'-10" 2x5'-2" 3x4'-3"	1x8'-9" 2x6'-2" 3x5'-2"	1x9'-5" 2x6'-6" 3x5'-2"	1x12'-8" 2x8'-9" 3x7'-2"	1x13'-8" 2x9'-4" 3x7'-6"
<b>Walkout Basement Walls of a Two Story Wood Framed Structure Supporting Wood Frame Floors and Roof (TYPE W2)</b>								
	6" & 8" Thick Wall	10" & 12" Thick Wall	6" & 8" Thick Wall	10" & 12" Thick Wall	6" & 8" Thick Wall	10" & 12" Thick Wall	6" & 8" Thick Wall	10" & 12" Thick Wall
	Number and length of shear walls provided							
2.44 (8)	1x6'-8" 2x4'-7" 3x3'-8"	1x6'-8" 2x4'-6" 3x3'-8"	1x6'-10" 2x4'-11" 3x3'-11"	1x6'-10" 2x4'-11" 3x3'-11"	1x8'-5" 2x5'-10" 3x4'-7"	1x8'-5" 2x5'-10" 3x4'-7"	1x11'-8" 2x8'-2" 3x6'-6"	1x11'-8" 2x8'-2" 3x6'-6"
2.75 (9)	1x7'-0" 2x4'-8" 3x3'-8"	1x7'-0" 2x4'-8" 3x3'-8"	1x7'-2" 2x5'-2" 3x3'-11"	1x7'-2" 2x5'-2" 3x3'-11"	1x8'-5" 2x6'-1" 3x4'-9"	1x8'-5" 2x6'-1" 3x4'-9"	1x12'-0" 2x8'-5" 3x6'-9"	1x12'-0" 2x8'-5" 3x6'-9"
3.05 (10)	1x7'-0" 2x4'-9" 3x4'-0"	1x7'-0" 2x4'-9" 3x4'-0"	1x7'-2" 2x5'-2" 3x3'-11"	1x7'-2" 2x5'-2" 3x3'-11"	1x8'-9" 2x6'-1" 3x4'-9"	1x8'-9" 2x6'-1" 3x4'-9"	1x12'-4" 2x8'-8" 3x6'-10"	1x12'-4" 2x8'-8" 3x6'-10"
3.66 (12)	1x7'-4" 2x5'-0" 3x4'-0"	1x7'-4" 2x5'-0" 3x4'-0"	1x7'-6" 2x5'-2" 3x4'-3"	1x7'-6" 2x5'-2" 3x4'-3"	1x9'-1" 2x6'-2" 3x4'-12"	1x9'-1" 2x6'-2" 3x4'-12"	1x12'-8" 2x8'-9" 3x7'-2"	1x12'-8" 2x8'-9" 3x7'-2"
<b>Walkout Basement Wall of a Two Story Building with Main Floor ICF Walls Supporting 2nd Story Wood Framed Walls, Floor and Roof (TYPE W3)</b>								
	6" & 8" Thick Wall	10" & 12" Thick Wall	6" & 8" Thick Wall	10" & 12" Thick Wall	6" & 8" Thick Wall	10" & 12" Thick Wall	6" & 8" Thick Wall	10" & 12" Thick Wall
	Number and length of shear walls provided							
2.44 (8)	1x6'-8" 2x4'-7" 3x3'-8"	1x6'-6" 2x4'-9" 3x3'-8"	1x8'-2" 2x5'-6" 3x4'-7"	1x8'-2" 2x5'-10" 3x4'-7"	1x9'-9" 2x6'-10" 3x5'-8"	1x10'-1" 2x6'-10" 3x5'-8"	1x13'-8" 2x9'-9" 3x7'-10"	1x14'-4" 2x9'-9" 3x7'-10"
2.75 (9)	1x7'-0" 2x4'-9" 3x3'-8"	1x6'-6" 2x4'-9" 3x3'-8"	1x8'-2" 2x5'-10" 3x4'-7"	1x8'-5" 2x5'-10" 3x4'-7"	1x10'-5" 2x6'-10" 3x5'-8"	1x10'-5" 2x7'-2" 3x5'-8"	1x13'-12" 2x9'-9" 3x8'-0"	1x14'-4" 2x10'-1" 3x8'-0"
3.05 (10)	1x7'-0" 2x4'-9" 3x4'-0"	1x6'-10" 2x4'-9" 3x4'-0"	1x8'-5" 2x5'-10" 3x4'-7"	1x8'-5" 2x5'-10" 3x4'-7"	1x10'-5" 2x7'-2" 3x5'-8"	1x10'-5" 2x7'-2" 3x5'-8"	1x14'-4" 2x10'-1" 3x8'-0"	1x14'-8" 2x10'-1" 3x8'-0"
3.66 (12)	1x7'-4" 2x5'-0" 3x4'-0"	1x7'-2" 2x4'-9" 3x4'-0"	1x8'-9" 2x6'-2" 3x4'-11"	1x8'-9" 2x6'-2" 3x4'-11"	1x10'-7" 2x7'-4" 3x5'-10"	1x10'-9" 2x7'-6" 3x6'-1"	1x15'-3" 2x10'-5" 3x8'-5"	1x15'-3" 2x10'-5" 3x8'-5"
<b>Walkout Basement Wall of Two Story ICF Structure Supporting Wood Frame Floors and Roof (TYPE W4)</b>								
	6" & 8" Thick Wall	10" & 12" Thick Wall	6" & 8" Thick Wall	10" & 12" Thick Wall	6" & 8" Thick Wall	10" & 12" Thick Wall	6" & 8" Thick Wall	10" & 12" Thick Wall
	Number and length of shear walls provided							
2.44 (8)	1x7'-2" 2x4'-11" 3x4'-1"	1x7'-10" 2x5'-2" 3x4'-1"	1x9'-1" 2x6'-6" 3x5'-2"	1x9'-8" 2x6'-6" 3x5'-2"	1x11'-4" 2x7'-10" 3x6'-2"	1x11'-8" 2x8'-2" 3x6'-6"	1x15'-7" 2x11'-1" 3x8'-9"	1x16'-3" 2x11'-8" 3x9'-5"
2.75 (9)	1x7'-6" 2x5'-2" 3x4'-1"	1x7'-10" 2x5'-2" 3x4'-1"	1x9'-9" 2x6'-6" 3x5'-2"	1x9'-9" 2x6'-10" 3x5'-6"	1x11'-8" 2x7'-10" 3x6'-6"	1x12'-0" 2x8'-4" 3x6'-8"	1x16'-3" 2x11'-1" 3x9'-1"	1x16'-11" 2x11'-8" 3x9'-5"
3.05 (10)	1x7'-6" 2x5'-2" 3x4'-1"	1x7'-10" 2x5'-5" 3x4'-3"	1x9'-9" 2x6'-6" 3x5'-6"	1x10'-0" 2x6'-10" 3x5'-6"	1x11'-8" 2x8'-2" 3x6'-6"	1x12'-4" 2x8'-5" 3x6'-10"	1x16'-3" 2x11'-8" 3x9'-1"	1x16'-11" 2x11'-8" 3x9'-9"
3.66 (12)	1x7'-10" 2x5'-0" 3x4'-4"	1x8'-2" 2x5'-6" 3x4'-7"	1x10'-5" 2x7'-2" 3x5'-10"	1x10'-5" 2x7'-2" 3x5'-10"	1x12'-0" 2x8'-5" 3x6'-10"	1x13'-0" 2x8'-9" 3x7'-2"	1x16'-11" 2x11'-8" 3x9'-5"	1x17'-7" 2x12'-4" 3x10'-1"
Vertical Reinforcement	6", 8" and 10" thick wall	15 M @ 300 (12)	15 M @ 300 (12)	15 M @ 300 (12)	15 M @ 300 (12)	15 M @ 300 (12)	15 M @ 300 (12)	15 M @ 300 (12)
Horizontal Reinforcement	12" thick wall	10 M @ 300 (12)	10 M @ 300 (12)	10 M @ 300 (12)	10 M @ 300 (12)	10 M @ 300 (12)	10 M @ 300 (12)	10 M @ 300 (12)
	Block Height of 12" and 18"	10 M @ 450 (16)	10 M @ 450 (16)	10 M @ 450 (16)	10 M @ 450 (16)	10 M @ 450 (16)	10 M @ 450 (16)	10 M @ 450 (16)
	Block Height of 16"	10 M @ 400 (16)	10 M @ 400 (16)	10 M @ 400 (16)	10 M @ 400 (16)	10 M @ 400 (16)	10 M @ 400 (16)	10 M @ 400 (16)

**NOTES:**

1.  $S_{a,ICF}$  is equivalent spectral response acceleration for ICF walls as provided in Appendix A.
2. This table is to be used in conjunction with the "Design Limitations."
3. Provide two layers of the indicated horizontal and vertical distributed steel specified for 300mm (12") walls. Place each layer as shown in the rebar placement drawing.
4. All four sides of the building are to have a minimum number and length of shear walls that conforms to this table.
5. Provide 2-15M concentrated reinforcement at each end of shear walls as shown in shear wall detail.
6. All concentrated reinforcement is to be continues to the bottom of the foundation wall. Provide lap splices as required.
7. Concentrated reinforcement is to be placed in accordance with Bar Placement Detail.
8. Horizontal reinforcement in shear walls where  $S_{a,ICF} > 0.16$  must be anchored using a standard 180° hook around vertical end bars.
9. Walkout basement shear walls are to be reviewed and designed by a structural engineer where  $S_{a,ICF} > 0.31$ .

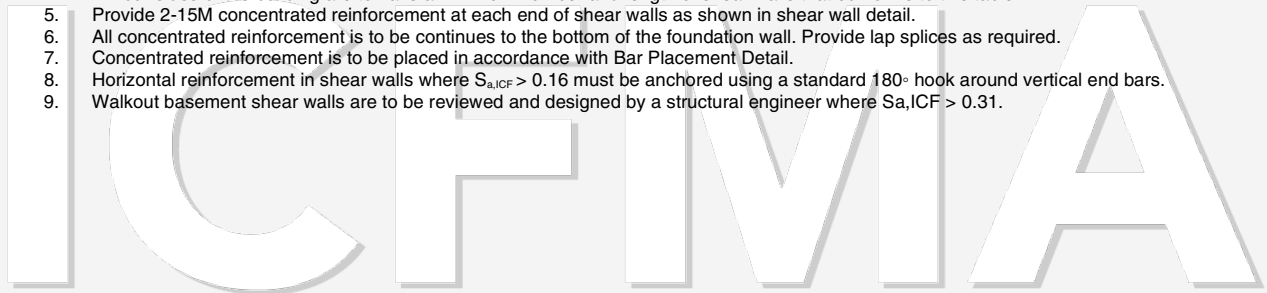

**INSULATING CONCRETE FORMS MANUFACTURERS ASSOCIATION**



# Lintel Details and Tables

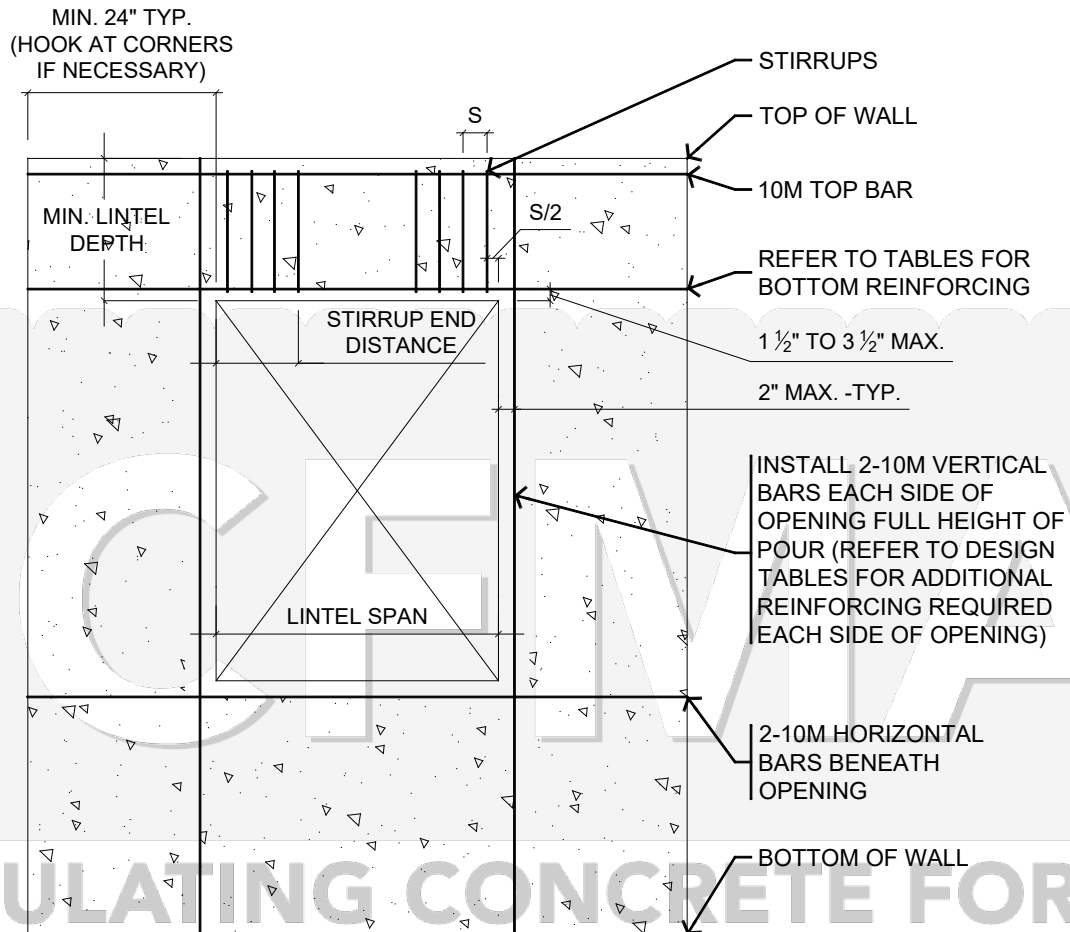

**Detail L. 1. Reinforcing Around Openings.**

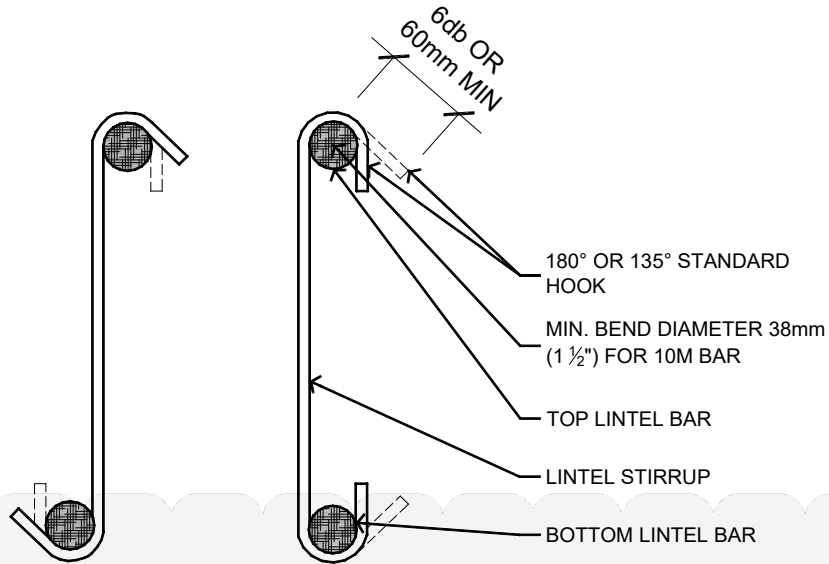

STIRRUP HOOKS IN  
OPPOSITE DIRECTION

STIRRUP HOOKS IN  
SAME DIRECTION

**Detail L. 2. Lintel Stirrup Detail.**

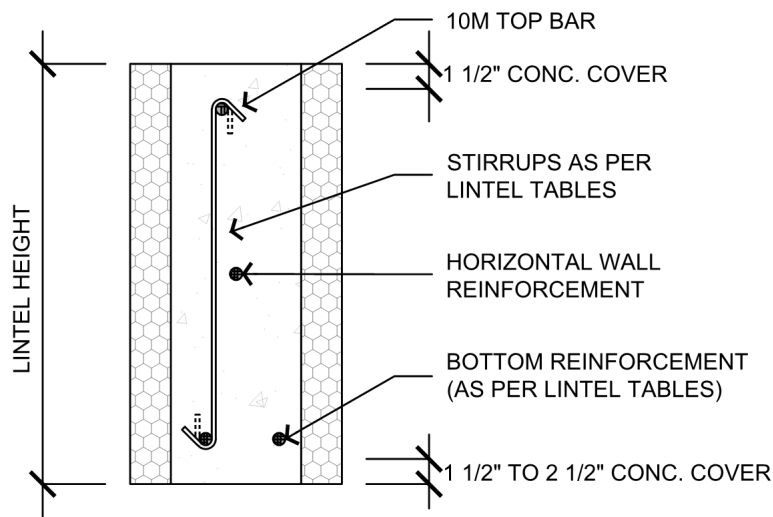

**Detail L. 3. Lintel Section**

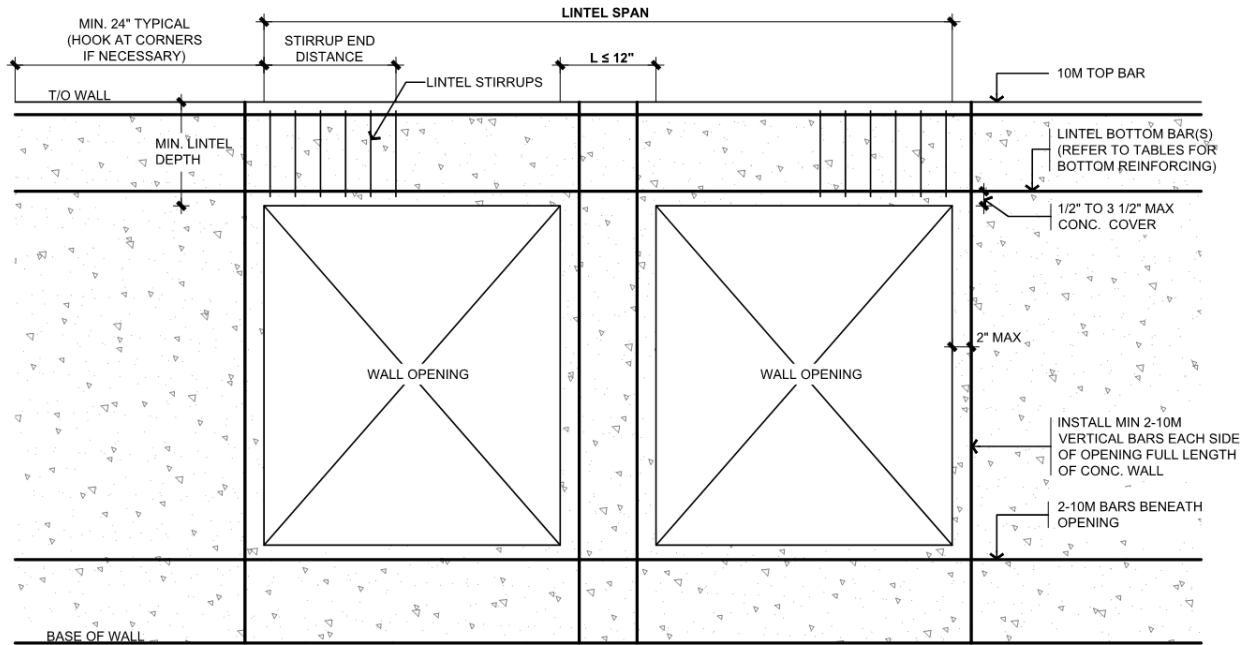

**Detail L. 4. Lintel Span with Less Than 305mm (12") of Wall Between Openings.**

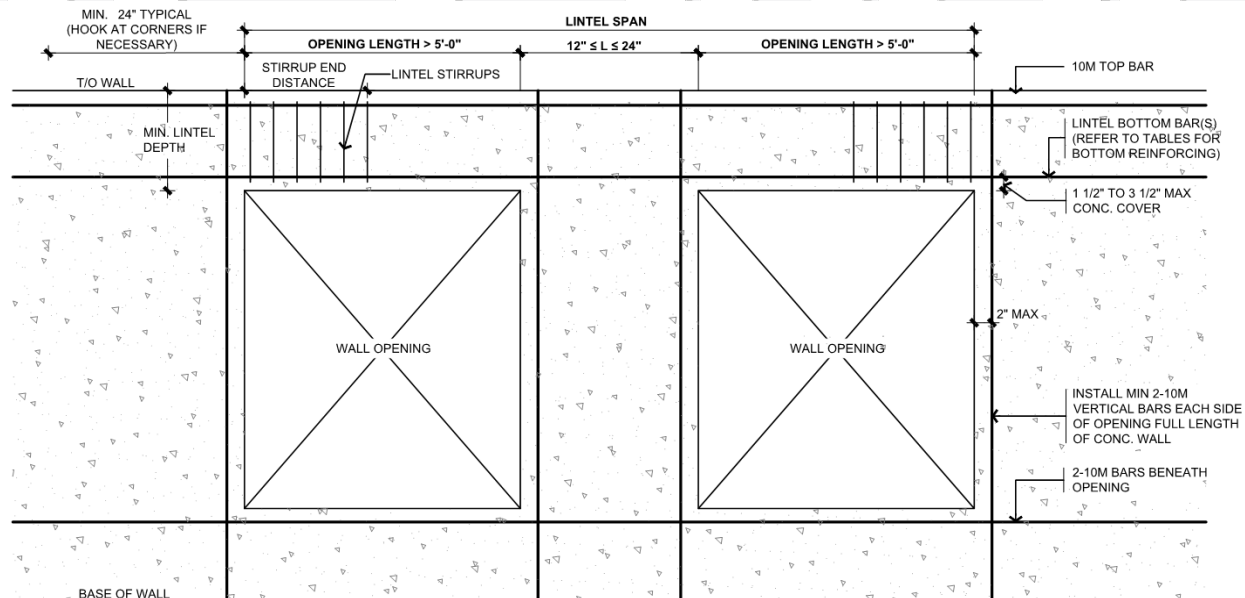

**Detail L. 5. Lintel Span with Less Than 610mm (24") of Wall Between Openings, and Openings Are Greater Than 1.53m (5'-0") in Length.**

**Table L. 1. 6" Lintel Reinforcement with Uniformly Distributed Load**

Lintel Span, mm (ft)	Lintel - 6" Thick x 8" Deep (150mm Thick x 200mm Deep), s = 3" (75mm)																	
	Uniformly Distributed Load																	
	7.5 kN/m		11 kN/m		14.5 kN/m		18 kN/m		21.5 kN/m		25.5 kN/m		29 kN/m		33 kN/m		36.5 kN/m	
	500 lb/ft		750 lb/ft		1000 lb/ft		1250 lb/ft		1500 lb/ft		1750 lb/ft		2000 lb/ft		2250 lb/ft		2500 lb/ft	
	Bottom Reinf. Steel	Stirrup End Dist.	Bottom Reinf. Steel	Stirrup End Dist.	Bottom Reinf. Steel	Stirrup End Dist.	Bottom Reinf. Steel	Stirrup End Dist.	Bottom Reinf. Steel	Stirrup End Dist.	Bottom Reinf. Steel	Stirrup End Dist.	Bottom Reinf. Steel	Stirrup End Dist.	Bottom Reinf. Steel	Stirrup End Dist.	Bottom Reinf. Steel	Stirrup End Dist.
900 (3)	1-10M	0	1-10M	0	1-10M	0	1-10M	0	1-15M	150 (6)	1-15M	150 (6)	1-15M	225 (9)	1-15M	225 (9)	1-15M	300 (12)
1200 (4)	1-10M	0	1-15M	0	1-15M	150 (6)	1-15M	225 (9)	1-20M	225 (9)	1-20M	300 (12)						
1500 (5)	1-15M	0	1-15M	150 (6)	1-20M	225 (9)												
1800 (6)	1-15M	0	1-20M	225 (9)														
2400 (8)																		
3000 (10)																		
3600 (12)																		
4200 (14)																		
4800 (16)																		
5400 (18)																		
6000 (20)																		

NOTES:

1. Stirrup spacing (s) and end distance are given in "mm" and "inch"
2. Do not install more than 1-20M bottom bar or equivalent combination of smaller bars.
3. Bottom reinforcement located 89mm (3.5") from bottom of lintel.
4. This table to be used in conjunction with the "Lintel Design Limitations" & "Lintel Drawing".
5. Cells with zero end distance do not require stirrups, except provide a minimum of three stirrups at each end of the lintel where  $S_{a,ICF} > 0.16$ .

Lintel Span, mm (ft)	Lintel - 6" Thick x 12" Deep (150mm Thick x 300mm Deep), s = 6" (150mm)																	
	Uniformly Distributed Load																	
	7.5 kN/m		11 kN/m		14.5 kN/m		18 kN/m		21.5 kN/m		25.5 kN/m		29 kN/m		33 kN/m		36.5 kN/m	
	500 lb/ft		750 lb/ft		1000 lb/ft		1250 lb/ft		1500 lb/ft		1750 lb/ft		2000 lb/ft		2250 lb/ft		2500 lb/ft	
	Bottom Reinf. Steel	Stirrup End Dist.	Bottom Reinf. Steel	Stirrup End Dist.	Bottom Reinf. Steel	Stirrup End Dist.	Bottom Reinf. Steel	Stirrup End Dist.	Bottom Reinf. Steel	Stirrup End Dist.	Bottom Reinf. Steel	Stirrup End Dist.	Bottom Reinf. Steel	Stirrup End Dist.	Bottom Reinf. Steel	Stirrup End Dist.	Bottom Reinf. Steel	Stirrup End Dist.
900 (3)	1-10M	0	1-10M	0	1-10M	0	1-10M	0	1-10M	0	1-10M	0	1-10M	300 (12)	1-15M	300 (12)	1-15M	300 (12)
1200 (4)	1-10M	0	1-10M	0	1-10M	0	1-15M	0	1-15M	300 (12)	1-15M	300 (12)	1-15M	300 (12)	1-15M	300 (12)	1-15M	450 (18)
1500 (5)	1-10M	0	1-15M	0	1-15M	0	1-15M	300 (12)	1-15M	300 (12)	1-15M	450 (18)	1-20M	450 (18)	1-20M	450 (18)	1-20M	600 (24)
1800 (6)	1-15M	0	1-15M	0	1-15M	300 (12)	1-15M	300 (12)	1-20M	450 (18)	1-20M	600 (24)	2-15M	600 (24)	2-15M	600 (24)	1-15M + 1-20M	750 (30)
2400 (8)	1-15M	0	1-20M	300 (12)	2-15M	600 (24)	2-15M	600 (24)	1-15M + 1-20M	750 (30)								
3000 (10)	1-20M	300 (12)	2-15M	600 (24)														
3600 (12)	1-15M + 1-20M	600 (24)																
4200 (14)																		
4800 (16)																		
5400 (18)																		
6000 (20)																		

NOTES:

1. Stirrup spacing (s) and end distance are given in "mm" and "inch"
2. Do not install more than 1-15M + 1-20M bottom bar or equivalent combination of smaller bars.
3. Bottom reinforcement located 89mm (3.5") from bottom of lintel.
4. This table to be used in conjunction with the "Lintel Design Limitations" & "Lintel Drawing".
5. Cells with zero end distance do not require stirrups, except provide a minimum of three stirrups at each end of the lintel where  $S_{a,ICF} > 0.16$ .

Lintel Span, mm (ft)	Lintel - 6" Thick x 16" Deep (150mm Thick x 400mm Deep), s = 8" (200mm)																	
	Uniformly Distributed Load																	
	7.5 kN/m 500 lb/ft		11 kN/m 750 lb/ft		14.5 kN/m 1000 lb/ft		18 kN/m 1250 lb/ft		21.5 kN/m 1500 lb/ft		25.5 kN/m 1750 lb/ft		29 kN/m 2000 lb/ft		36.5 kN/m 2500 lb/ft		43.5 kN/m 3000 lb/ft	
	Bottom Reinf. Steel	Stirrup End Dist.	Bottom Reinf. Steel	Stirrup End Dist.	Bottom Reinf. Steel	Stirrup End Dist.	Bottom Reinf. Steel	Stirrup End Dist.	Bottom Reinf. Steel	Stirrup End Dist.	Bottom Reinf. Steel	Stirrup End Dist.	Bottom Reinf. Steel	Stirrup End Dist.	Bottom Reinf. Steel	Stirrup End Dist.	Bottom Reinf. Steel	Stirrup End Dist.
900 (3)	1-10M	0	1-10M	0	1-10M	0	1-10M	0	1-10M	0	1-10M	0	1-10M	0	1-10M	0	1-10M	400 (16)
1200 (4)	1-10M	0	1-10M	0	1-10M	0	1-10M	0	1-10M	0	1-10M	0	1-15M	400 (16)	1-15M	400 (16)	1-15M	400 (16)
1500 (5)	1-10M	0	1-10M	0	1-10M	0	1-15M	0	1-15M	400 (16)	1-15M	400 (16)	1-15M	400 (16)	1-15M	600 (24)	1-15M	600 (24)
1800 (6)	1-10M	0	1-15M	0	1-15M	0	1-15M	400 (16)	1-15M	400 (16)	1-15M	400 (16)	1-15M	600 (24)	1-20M	600 (24)	2-20M	800 (32)
2400 (8)	1-15M	0	1-15M	0	1-15M	400 (16)	1-20M	600 (24)	1-20M	600 (24)	2-15M	800 (32)	2-15M	800 (32)	1-15M + 1-20M	1000 (40)		
3000 (10)	1-15M	0	1-20M	400 (16)	2-15M	600 (24)	2-15M	800 (32)	1-15M + 1-20M	1000 (40)	2-20M	1000 (40)	1-10M + 2-20M	1200 (48)				
3600 (12)	1-20M	400 (16)	2-15M	800 (32)	1-15M + 1-20M	1000 (40)	1-10M + 2-20M	1200 (48)	1-15M + 2-20M	1200 (48)								
4200 (14)	2-15M	600 (24)	2-20M	1000 (40)	1-15M + 2-20M	1200 (48)												
4800 (16)	2-20M	800 (32)	1-15M + 2-20M	1400 (56)														
5400 (18)	1-15M + 2-20M	1200 (48)																
6000 (20)																		

NOTES:

1. Stirrup spacing (s) and end distance are given in "mm" and "inch"
2. Do not install more than 1-15M + 2-20M bottom bar or equivalent combination of smaller bars.
3. Bottom reinforcement located 89mm (3.5") from bottom of lintel.
4. This table to be used in conjunction with the "Lintel Design Limitations" & "Lintel Drawing".
5. Cells with zero end distance do not require stirrups, except provide a minimum of three stirrups at each end of the lintel where  $S_a(0.2) > 0.16$ .

Lintel Span, mm (ft)	Lintel - 6" Thick x 24" Deep (150mm Thick x 600mm Deep), s = 12" (300mm)																	
	Uniformly Distributed Load																	
	7.5 kN/m 500 lb/ft		11 kN/m 750 lb/ft		14.5 kN/m 1000 lb/ft		18 kN/m 1250 lb/ft		21.5 kN/m 1500 lb/ft		29 kN/m 2000 lb/ft		36.5 kN/m 2500 lb/ft		43.5 kN/m 3000 lb/ft		51 kN/m 3500 lb/ft	
	Bottom Reinf. Steel	Stirrup End Dist.	Bottom Reinf. Steel	Stirrup End Dist.	Bottom Reinf. Steel	Stirrup End Dist.	Bottom Reinf. Steel	Stirrup End Dist.	Bottom Reinf. Steel	Stirrup End Dist.	Bottom Reinf. Steel	Stirrup End Dist.	Bottom Reinf. Steel	Stirrup End Dist.	Bottom Reinf. Steel	Stirrup End Dist.	Bottom Reinf. Steel	Stirrup End Dist.
900 (3)	1-10M	0	1-10M	0	1-10M	0	1-10M	0	1-10M	0	1-10M	0	1-10M	0	1-10M	0	1-10M	0
1200 (4)	1-10M	0	1-10M	0	1-10M	0	1-10M	0	1-10M	0	1-10M	0	1-10M	0	1-10M	600 (24)	1-15M	600 (24)
1500 (5)	1-10M	0	1-10M	0	1-10M	0	1-10M	0	1-10M	0	1-15M	0	1-15M	600 (24)	1-15M	600 (24)	1-15M	600 (24)
1800 (6)	1-10M	0	1-10M	0	1-10M	0	1-15M	0	1-15M	0	1-15M	600 (24)	1-15M	600 (24)	1-15M	600 (24)	1-15M	600 (24)
2400 (8)	1-10M	0	1-15M	0	1-15M	0	1-15M	600 (24)	1-15M	600 (24)	1-20M	600 (24)	1-20M	900 (36)	2-15M	900 (36)	2-15M	900 (36)
3000 (10)	1-15M	0	1-15M	0	1-15M	600 (24)	1-20M	600 (24)	1-20M	900 (36)	2-15M	900 (36)	1-15M + 1-20M	1200 (48)	2-20M	1200 (48)		
3600 (12)	1-15M	0	1-20M	600 (24)	1-20M	600 (24)	2-15M	900 (36)	2-15M	1200 (48)	2-20M	1200 (48)	1-10M + 2-20M	1500 (60)				
4200 (14)	1-20M	0	1-20M	600 (24)	2-15M	900 (36)	1-15M + 1-20M	1200 (48)	2-20M	1500 (60)	1-15M + 2-20M	1500 (60)						
4800 (16)	1-20M	600 (24)	2-15M	900 (36)	1-15M + 1-20M	1200 (48)	1-10M + 2-20M	1500 (60)	1-15M + 2-20M	1800 (72)	1-15M + 3-20M	1800 (72)						
5400 (18)	2-15M	600 (24)	2-20M	1200 (48)	1-10M + 2-20M	1500 (60)	3-20M	1800 (72)	1-15M + 3-20M	2100 (84)								
6000 (20)	1-15M + 1-20M	900 (36)	1-10M + 2-20M	1500 (60)	3-20M	1800 (72)	3-20M	2100 (84)										

NOTES:

1. Stirrup spacing (s) and end distance are given in "mm" and "inch"
2. Do not install more than 4-20M bottom bar or equivalent combination of smaller bars.
3. Bottom reinforcement located 89mm (3.5") from bottom of lintel.
4. This table to be used in conjunction with the "Lintel Design Limitations" & "Lintel Drawing".
5. Cells with zero end distance do not require stirrups, except provide a minimum of three stirrups at each end of the lintel where  $S_{a,ICF} > 0.16$ .

Lintel Span, mm (ft)	Lintel - 6" Thick x 32" Deep (150mm Thick x 800mm Deep), s = 16" (400mm)																	
	Uniformly Distributed Load																	
	7.5 kN/m 500 lb/ft		11 kN/m 750 lb/ft		14.5 kN/m 1000 lb/ft		18 kN/m 1250 lb/ft		21.5 kN/m 1500 lb/ft		29 kN/m 2000 lb/ft		36.5 kN/m 2500 lb/ft		43.5 kN/m 3000 lb/ft		51 kN/m 3500 lb/ft	
	Bottom Reinf. Steel	Stirrup End Dist.	Bottom Reinf. Steel	Stirrup End Dist.	Bottom Reinf. Steel	Stirrup End Dist.	Bottom Reinf. Steel	Stirrup End Dist.	Bottom Reinf. Steel	Stirrup End Dist.	Bottom Reinf. Steel	Stirrup End Dist.	Bottom Reinf. Steel	Stirrup End Dist.	Bottom Reinf. Steel	Stirrup End Dist.	Bottom Reinf. Steel	Stirrup End Dist.
900 (3)	1-10M	0	1-10M	0	1-10M	0	1-10M	0	1-10M	0	1-10M	0	1-10M	0	1-10M	0	1-10M	0
1200 (4)	1-10M	0	1-10M	0	1-10M	0	1-10M	0	1-10M	0	1-10M	0	1-10M	0	1-10M	0	1-10M	400 (16)
1500 (5)	1-10M	0	1-10M	0	1-10M	0	1-10M	0	1-10M	0	1-10M	0	1-10M	0	1-15M	400 (16)	1-15M	400 (16)
1800 (6)	1-10M	0	1-10M	0	1-10M	0	1-10M	0	1-10M	0	1-15M	0	1-15M	800 (32)	1-15M	800 (32)	1-15M	800 (32)
2400 (8)	1-10M	0	1-10M	0	1-15M	0	1-15M	0	1-15M	0	1-20M	800 (32)	1-20M	800 (32)	1-20M	800 (32)	1-20M	1200 (48)
3000 (10)	1-15M	0	1-15M	0	1-15M	0	1-20M	800 (32)	1-20M	800 (32)	1-20M	800 (32)	2-15M	1200 (48)	2-15M	1200 (48)	1-15M+	1200 (48)
3600 (12)	1-15M	0	1-20M	0	1-20M	800 (32)	1-20M	800 (32)	1-20M	800 (32)	2-15M	1200 (48)	1-15M+	1600 (64)				
4200 (14)	1-20M	0	1-20M	0	1-20M	800 (32)	2-15M	1200 (48)	2-15M	1200 (48)	1-15M+	1600 (64)	1-20M	2000 (80)				
4800 (16)	1-20M	0	1-20M	800 (32)	2-15M	1200 (48)	1-15M+	1200 (48)	1-15M+	1600 (64)	1-10M+	2000 (80)	2-20M	2000 (80)				
5400 (18)	1-20M	0	2-15M	800 (32)	1-15M+	1200 (48)	2-20M	1600 (64)	2-20M	2000 (80)								
6000 (20)	2-15M	800 (32)	1-15M+	1200 (48)	2-20M	1600 (64)	1-10M+	2000 (80)	3-20M	2000 (80)								

NOTES:

1. Stirrup spacing (s) and end distance are given in "mm" and "inch"
2. Do not install more than 4-20M bottom bar or equivalent combination of smaller bars.
3. Bottom reinforcement located 89mm (3.5") from bottom of lintel.
4. This table to be used in conjunction with the "Lintel Design Limitations" & "Lintel Drawing".
5. Cells with zero end distance do not require stirrups, except provide a minimum of three stirrups at each end of the lintel where  $S_{a,ICF} > 0.16$ .

# ICFMA

## INSULATING CONCRETE FORMS MANUFACTURERS ASSOCIATION

**Table L. 2. 8" Lintel Reinforcement with Uniformly Distributed Load**

Lintel Span, mm (ft)	Lintel - 8" Thick x 8" Deep (200mm Thick x 200mm Deep), s = 3" (75mm)																	
	Uniformly Distributed Load																	
	7.5 kN/m		11 kN/m		14.5 kN/m		18 kN/m		21.5 kN/m		25.5 kN/m		29 kN/m		33 kN/m		36.5 kN/m	
	500 lb/ft		750 lb/ft		1000 lb/ft		1250 lb/ft		1500 lb/ft		1750 lb/ft		2000 lb/ft		2250 lb/ft		2500 lb/ft	
	Bottom Reinf. Steel	Stirrup End Dist.	Bottom Reinf. Steel	Stirrup End Dist.	Bottom Reinf. Steel	Stirrup End Dist.	Bottom Reinf. Steel	Stirrup End Dist.	Bottom Reinf. Steel	Stirrup End Dist.	Bottom Reinf. Steel	Stirrup End Dist.	Bottom Reinf. Steel	Stirrup End Dist.	Bottom Reinf. Steel	Stirrup End Dist.	Bottom Reinf. Steel	Stirrup End Dist.
900 (3)	1-10M	0	1-10M	0	1-10M	0	1-15M	0	1-15M	0	1-15M	150 (6)	1-15M	150 (6)	1-15M	225 (9)	1-15M	225 (9)
1200 (4)	1-15M	0	1-15M	0	1-15M	0	1-15M	150 (6)	1-15M	150 (6)	1-20M	225 (9)	1-20M	300 (12)				
1500 (5)	1-15M	0	1-15M	0	1-20M	150 (6)	1-20M	225 (9)										
1800 (6)	1-15M	0	1-20M	150 (6)														
2400 (8)																		
3000 (10)																		
3600 (12)																		
4200 (14)																		
4800 (16)																		
5400 (18)																		
6000 (20)																		

NOTES:

1. Stirrup spacing (s) and end distance are given in "mm" and "inch"
2. Do not install more than 1-20M bottom bar or equivalent combination of smaller bars.
3. Bottom reinforcement located 89mm (3.5") from bottom of lintel.
4. This table to be used in conjunction with the "Lintel Design Limitations" & "Lintel Drawing".
5. Cells with zero end distance do not require stirrups, except provide a minimum of three stirrups at each end of the lintel where  $S_{a,ICF} > 0.16$ .

Lintel Span, mm (ft)	Lintel - 8" Thick x 12" Deep (200mm Thick x 300mm Deep), s = 6" (150mm)																	
	Uniformly Distributed Load																	
	7.5 kN/m		11 kN/m		14.5 kN/m		18 kN/m		21.5 kN/m		25.5 kN/m		29 kN/m		33 kN/m		36.5 kN/m	
	500 lb/ft		750 lb/ft		1000 lb/ft		1250 lb/ft		1500 lb/ft		1750 lb/ft		2000 lb/ft		2250 lb/ft		2500 lb/ft	
	Bottom Reinf. Steel	Stirrup End Dist.	Bottom Reinf. Steel	Stirrup End Dist.	Bottom Reinf. Steel	Stirrup End Dist.	Bottom Reinf. Steel	Stirrup End Dist.	Bottom Reinf. Steel	Stirrup End Dist.	Bottom Reinf. Steel	Stirrup End Dist.	Bottom Reinf. Steel	Stirrup End Dist.	Bottom Reinf. Steel	Stirrup End Dist.	Bottom Reinf. Steel	Stirrup End Dist.
900 (3)	1-10M	0	1-10M	0	1-10M	0	1-10M	0	1-10M	0	1-10M	0	1-10M	0	1-15M	0	1-15M	300 (12)
1200 (4)	1-10M	0	1-10M	0	1-10M	0	1-15M	0	1-15M	0	1-15M	300 (12)	1-15M	300 (12)	1-15M	300 (12)	1-15M	300 (12)
1500 (5)	1-10M	0	1-15M	0	1-15M	0	1-15M	0	1-15M	300 (12)	1-15M	300 (12)	1-15M	300 (12)	1-20M	450 (18)	1-20M	450 (18)
1800 (6)	1-15M	0	1-15M	0	1-15M	0	1-15M	300 (12)	1-20M	300 (12)	1-20M	450 (18)	2-15M	600 (24)	2-15M	600 (24)	2-15M	600 (24)
2400 (8)	1-15M	0	1-20M	0	1-20M	450 (18)	2-15M	600 (24)	1-15M+1-20M	600 (24)	2-20M	750 (30)						
3000 (10)	1-20M	0	2-15M	450 (18)	2-20M	750 (30)												
3600 (12)	1-15M+1-20M	300 (12)																
4200 (14)																		
4800 (16)																		
5400 (18)																		
6000 (20)																		

NOTES:

1. Stirrup spacing (s) and end distance are given in "mm" and "inch"
2. Do not install more than 2-20M bottom bar or equivalent combination of smaller bars.
3. Bottom reinforcement located 89mm (3.5") from bottom of lintel.
4. This table to be used in conjunction with the "Lintel Design Limitations" & "Lintel Drawing".
5. Cells with zero end distance do not require stirrups, except provide a minimum of three stirrups at each end of the lintel where  $S_{a,ICF} > 0.16$ .

Lintel Span, mm (ft)	Lintel - 8" Thick x 16" Deep (200mm Thick x 400mm Deep), s = 8" (200mm)																	
	Uniformly Distributed Load																	
	7.5 kN/m		11 kN/m		14.5 kN/m		18 kN/m		21.5 kN/m		25.5 kN/m		29 kN/m		36.5 kN/m		43.5 kN/m	
	500 lb/ft		750 lb/ft		1000 lb/ft		1250 lb/ft		1500 lb/ft		1750 lb/ft		2000 lb/ft		2500 lb/ft		3000 lb/ft	
	Bottom Reinf. Steel	Stirrup End Dist.	Bottom Reinf. Steel	Stirrup End Dist.	Bottom Reinf. Steel	Stirrup End Dist.	Bottom Reinf. Steel	Stirrup End Dist.	Bottom Reinf. Steel	Stirrup End Dist.	Bottom Reinf. Steel	Stirrup End Dist.	Bottom Reinf. Steel	Stirrup End Dist.	Bottom Reinf. Steel	Stirrup End Dist.	Bottom Reinf. Steel	Stirrup End Dist.
900 (3)	1-10M	0	1-10M	0	1-10M	0	1-10M	0	1-10M	0	1-10M	0	1-10M	0	1-10M	0	1-10M	0
1200 (4)	1-10M	0	1-10M	0	1-10M	0	1-10M	0	1-10M	0	1-10M	0	1-15M	0	1-15M	400 (16)	1-15M	400 (16)
1500 (5)	1-10M	0	1-10M	0	1-10M	0	1-15M	0	1-15M	0	1-15M	400 (16)	1-15M	400 (16)	1-15M	400 (16)	1-15M	400 (16)
1800 (6)	1-10M	0	1-15M	0	1-15M	0	1-15M	0	1-15M	400 (16)	1-15M	400 (16)	1-15M	400 (16)	1-20M	600 (24)	1-20M	600 (24)
2400 (8)	1-15M	0	1-15M	0	1-15M	0	1-20M	400 (16)	1-20M	600 (24)	2-15M	600 (24)	2-15M	800 (32)	1-15M + 1-20M	800 (32)	2-20M	1000 (40)
3000 (10)	1-15M	0	1-20M	0	2-15M	400 (16)	2-15M	800 (32)	1-15M + 1-20M	800 (32)	2-20M	1000 (40)	1-10M + 2-20M	1000 (40)				
3600 (12)	1-20M	0	2-15M	600 (24)	1-15M + 1-20M	800 (32)	2-20M	1000 (40)	1-10M + 2-20M	1200 (48)	3-20M	1200 (48)						
4200 (14)	2-15M	400 (16)	2-20M	800 (32)	1-10M + 2-20M	1200 (48)	3-20M	1400 (56)										
4800 (16)	2-20M	600 (24)	1-15M + 2-20M	1200 (48)														
5400 (18)	1-10M + 2-20M	1000 (40)																
6000 (20)	3-20M	1200 (48)																

NOTES:

1. Stirrup spacing (s) and end distance are given in "mm" and "inch"
2. Do not install more than 3-20M bottom bar or equivalent combination of smaller bars.
3. Bottom reinforcement located 89mm (3.5") from bottom of lintel.
4. This table to be used in conjunction with the "Lintel Design Limitations" & "Lintel Drawing".
5. Cells with zero end distance do not require stirrups, except provide a minimum of three stirrups at each end of the lintel where  $S_{a,ICF} > 0.16$ .

Lintel Span, mm (ft)	Lintel - 8" Thick x 24" Deep (200mm Thick x 600mm Deep), s = 12" (300mm)																	
	Uniformly Distributed Load																	
	7.5 kN/m		11 kN/m		14.5 kN/m		18 kN/m		21.5 kN/m		29 kN/m		36.5 kN/m		43.5 kN/m		51 kN/m	
	500 lb/ft		750 lb/ft		1000 lb/ft		1250 lb/ft		1500 lb/ft		2000 lb/ft		2500 lb/ft		3000 lb/ft		3500 lb/ft	
	Bottom Reinf. Steel	Stirrup End Dist.	Bottom Reinf. Steel	Stirrup End Dist.	Bottom Reinf. Steel	Stirrup End Dist.	Bottom Reinf. Steel	Stirrup End Dist.	Bottom Reinf. Steel	Stirrup End Dist.	Bottom Reinf. Steel	Stirrup End Dist.	Bottom Reinf. Steel	Stirrup End Dist.	Bottom Reinf. Steel	Stirrup End Dist.	Bottom Reinf. Steel	Stirrup End Dist.
900 (3)	1-10M	0	1-10M	0	1-10M	0	1-10M	0	1-10M	0	1-10M	0	1-10M	0	1-10M	0	1-10M	0
1200 (4)	1-10M	0	1-10M	0	1-10M	0	1-10M	0	1-10M	0	1-10M	0	1-10M	0	1-10M	0	1-15M	600 (24)
1500 (5)	1-10M	0	1-10M	0	1-10M	0	1-10M	0	1-10M	0	1-15M	0	1-15M	0	1-15M	600 (24)	1-15M	600 (24)
1800 (6)	1-10M	0	1-10M	0	1-10M	0	1-15M	0	1-15M	0	1-15M	0	1-15M	600 (24)	1-20M	600 (24)	1-20M	600 (24)
2400 (8)	1-10M	0	1-15M	0	1-15M	0	1-15M	0	1-20M	600 (24)	1-20M	600 (24)	1-20M	900 (36)	2-15M	900 (36)	2-15M	900 (36)
3000 (10)	1-15M	0	1-20M	0	1-20M	0	1-20M	600 (24)	1-20M	600 (24)	2-15M	900 (36)	1-15M + 1-20M	1200 (48)	1-15M + 1-20M	1200 (48)	2-20M	1200 (48)
3600 (12)	1-20M	0	1-20M	0	1-20M	600 (24)	2-15M	600 (24)	2-15M	900 (36)	1-15M + 1-20M	1200 (48)	1-10M + 2-20M	1500 (60)				
4200 (14)	1-20M	0	2-15M	600 (24)	2-15M	900 (36)	1-15M + 1-20M	900 (36)	2-20M	1200 (48)	1-15M + 2-20M	1500 (60)	1-10M + 3-20M	1800 (72)				
4800 (16)	2-15M	0	2-15M	600 (24)	2-20M	1200 (48)	1-10M + 2-20M	1200 (48)	1-15M + 2-20M	1500 (60)	1-10M + 3-20M	1800 (72)						
5400 (18)	2-15M	600 (24)	2-20M	900 (36)	1-10M + 2-20M	1500 (60)	1-15M + 2-20M	1500 (60)	1-10M + 3-20M	1800 (72)								
6000 (20)	1-15M + 1-20M	600 (24)	1-10M + 2-20M	1200 (48)	3-20M	1800 (72)	3-20M	1800 (72)										

NOTES:

1. Stirrup spacing (s) and end distance are given in "mm" and "inch"
2. Do not install more than 4-20M bottom bar or equivalent combination of smaller bars.
3. Bottom reinforcement located 89mm (3.5") from bottom of lintel.
4. This table to be used in conjunction with the "Lintel Design Limitations" & "Lintel Drawing".
5. Cells with zero end distance do not require stirrups, except provide a minimum of three stirrups at each end of the lintel where  $S_{a,ICF} > 0.16$ .



Lintel Span, mm (ft)	Lintel - 8" Thick x 32" Deep (200mm Thick x 800mm Deep), s = 16" (400mm)																	
	Uniformly Distributed Load																	
	7.5 kN/m 500 lb/ft		11 kN/m 750 lb/ft		14.5 kN/m 1000 lb/ft		18 kN/m 1250 lb/ft		21.5 kN/m 1500 lb/ft		29 kN/m 2000 lb/ft		36.5 kN/m 2500 lb/ft		43.5 kN/m 3000 lb/ft		51 kN/m 3500 lb/ft	
	Bottom Reinf. Steel	Stirrup End Dist.	Bottom Reinf. Steel	Stirrup End Dist.	Bottom Reinf. Steel	Stirrup End Dist.	Bottom Reinf. Steel	Stirrup End Dist.	Bottom Reinf. Steel	Stirrup End Dist.	Bottom Reinf. Steel	Stirrup End Dist.	Bottom Reinf. Steel	Stirrup End Dist.	Bottom Reinf. Steel	Stirrup End Dist.	Bottom Reinf. Steel	Stirrup End Dist.
900 (3)	1-10M	0	1-10M	0	1-10M	0	1-10M	0	1-10M	0	1-10M	0	1-10M	0	1-10M	0	1-10M	0
1200 (4)	1-10M	0	1-10M	0	1-10M	0	1-10M	0	1-10M	0	1-10M	0	1-10M	0	1-10M	0	1-10M	0
1500 (5)	1-10M	0	1-10M	0	1-10M	0	1-10M	0	1-10M	0	1-10M	0	1-10M	0	1-15M	0	1-15M	400 (16)
1800 (6)	1-10M	0	1-10M	0	1-10M	0	1-10M	0	1-10M	0	1-15M	0	1-15M	0	1-15M	800 (32)	1-15M	800 (32)
2400 (8)	1-10M	0	1-10M	0	1-15M	0	1-15M	0	1-15M	0	1-20M	800 (32)	1-20M	800 (32)	2-15M	800 (32)	2-15M	800 (32)
3000 (10)	1-15M	0	1-15M	0	1-15M	0	1-20M	0	1-20M	800 (32)	2-15M	800 (32)	2-15M	800 (32)	2-15M	1200 (48)	2-15M	1200 (48)
3600 (12)	1-15M	0	1-20M	0	1-20M	0	2-15M	800 (32)	2-15M	800 (32)	2-15M	1200 (48)	1-15M+ 1-20M	1200 (48)	2-20M	1600 (64)		
4200 (14)	1-20M	0	2-15M	0	2-15M	800 (32)	2-15M	800 (32)	2-15M	1200 (48)	1-15M+ 1-20M	1200 (48)	1-10M+ 2-20M	1600 (64)				
4800 (16)	2-15M	0	2-15M	0	2-15M	800 (32)	1-15M+ 1-20M	1200 (48)	2-20M	1200 (48)	1-10M+ 2-20M	1600 (64)						
5400 (18)	2-15M	0	2-15M	800 (32)	1-15M+ 1-20M	1200 (48)	2-20M	1600 (64)	1-10M+ 2-20M	1600 (64)	3-20M	2000 (80)						
6000 (20)	2-15M	0	1-15M+ 1-20M	800 (32)	2-20M	1600 (64)	1-10M+ 2-20M	1600 (64)	3-20M	2000 (80)								

NOTES:

1. Stirrup spacing (s) and end distance are given in "mm" and "inch"
2. Do not install more than 4-20M bottom bar or equivalent combination of smaller bars.
3. Bottom reinforcement located 89mm (3.5") from bottom of lintel.
4. This table to be used in conjunction with the "Lintel Design Limitations" & "Lintel Drawing".
5. Cells with zero end distance do not require stirrups, except provide a minimum of three stirrups at each end of the lintel where  $S_{a,ICF} > 0.16$ .

# ICFMA

## INSULATING CONCRETE FORMS MANUFACTURERS ASSOCIATION

**Table L. 3. 10" Lintel Reinforcement with Uniformly Distributed Load**

Lintel Span, mm (ft)	<b>Lintel - 10" Thick x 8" Deep (250mm Thick x 200mm Deep), s = 3" (75mm)</b>																	
	Uniformly Distributed Load																	
	7.5 kN/m		11 kN/m		14.5 kN/m		18 kN/m		21.5 kN/m		25.5 kN/m		29 kN/m		33 kN/m		36.5 kN/m	
	500 lb/ft		750 lb/ft		1000 lb/ft		1250 lb/ft		1500 lb/ft		1750 lb/ft		2000 lb/ft		2250 lb/ft		2500 lb/ft	
	Bottom Reinf. Steel	Stirrup End Dist.	Bottom Reinf. Steel	Stirrup End Dist.	Bottom Reinf. Steel	Stirrup End Dist.	Bottom Reinf. Steel	Stirrup End Dist.	Bottom Reinf. Steel	Stirrup End Dist.	Bottom Reinf. Steel	Stirrup End Dist.	Bottom Reinf. Steel	Stirrup End Dist.	Bottom Reinf. Steel	Stirrup End Dist.	Bottom Reinf. Steel	Stirrup End Dist.
900 (3)	1-10M	0	1-10M	0	1-10M	0	1-15M	0	1-15M	0	1-15M	0	1-15M	0	2-15M	150 (6)	2-15M	150 (6)
1200 (4)	1-15M	0	1-15M	0	1-15M	0	1-15M	0	1-15M	0	1-20M	150 (6)	2-15M	225 (9)				
1500 (5)	1-15M	0	1-15M	0	1-20M	0	1-20M	150 (6)	2-15M	225 (9)								
1800 (6)	1-15M	0	1-20M	0	2-15M	150 (6)												
2400 (8)	2-15M	0																
3000 (10)																		
3600 (12)																		
4200 (14)																		
4800 (16)																		
5400 (18)																		
6000 (20)																		

NOTES:

1. Stirrup spacing (s) and end distance are given in "mm" and "inch"
2. Do not install more than 2-15M bottom bar or equivalent combination of smaller bars.
3. Bottom reinforcement located 89mm (3.5") from bottom of lintel.
4. This table to be used in conjunction with the "Lintel Design Limitations" & "Lintel Drawing".
5. Cells with zero end distance do not require stirrups, except provide a minimum of three stirrups at each end of the lintel where  $S_{a,ICF} > 0.16$ .

Lintel Span, mm (ft)	<b>Lintel - 10" Thick x 12" Deep (250mm Thick x 300mm Deep), s = 6" (150mm)</b>																	
	Uniformly Distributed Load																	
	7.5 kN/m		11 kN/m		14.5 kN/m		18 kN/m		21.5 kN/m		25.5 kN/m		29 kN/m		33 kN/m		36.5 kN/m	
	500 lb/ft		750 lb/ft		1000 lb/ft		1250 lb/ft		1500 lb/ft		1750 lb/ft		2000 lb/ft		2250 lb/ft		2500 lb/ft	
	Bottom Reinf. Steel	Stirrup End Dist.	Bottom Reinf. Steel	Stirrup End Dist.	Bottom Reinf. Steel	Stirrup End Dist.	Bottom Reinf. Steel	Stirrup End Dist.	Bottom Reinf. Steel	Stirrup End Dist.	Bottom Reinf. Steel	Stirrup End Dist.	Bottom Reinf. Steel	Stirrup End Dist.	Bottom Reinf. Steel	Stirrup End Dist.	Bottom Reinf. Steel	Stirrup End Dist.
900 (3)	1-10M	0	1-10M	0	1-10M	0	1-10M	0	1-10M	0	1-10M	0	1-10M	0	1-15M	0	1-15M	0
1200 (4)	1-10M	0	1-10M	0	1-10M	0	1-15M	0	1-15M	0	1-15M	0	1-15M	0	1-15M	300 (12)	1-15M	300 (12)
1500 (5)	1-10M	0	1-15M	0	1-15M	0	1-15M	0	1-15M	0	1-15M	300 (12)	1-15M	300 (12)	1-20M	300 (12)	1-20M	300 (12)
1800 (6)	1-15M	0	1-15M	0	1-15M	0	1-15M	0	1-20M	300 (12)	1-20M	300 (12)	2-15M	450 (18)	2-15M	450 (18)	2-15M	450 (18)
2400 (8)	1-15M	0	1-20M	0	1-20M	0	2-15M	300 (12)	1-15M + 1-20M	450 (18)	2-20M	600 (24)	2-20M	750 (30)	1-10M + 2-20M	750 (30)		
3000 (10)	1-20M	0	2-15M	0	1-15M + 1-20M	450 (18)	1-10M + 2-20M	600 (24)										
3600 (12)	1-15M + 1-20M	0	2-20M	450 (18)														
4200 (14)	1-10M + 2-20M	300 (12)																
4800 (16)																		
5400 (18)																		
6000 (20)																		

NOTES:

1. Stirrup spacing (s) and end distance are given in "mm" and "inch"
2. Do not install more than 1-10M + 2-20M bottom bar or equivalent combination of smaller bars.
3. Bottom reinforcement located 89mm (3.5") from bottom of lintel.
4. This table to be used in conjunction with the "Lintel Design Limitations" & "Lintel Drawing".
5. Cells with zero end distance do not require stirrups, except provide a minimum of three stirrups at each end of the lintel where  $S_{a,ICF} > 0.16$ .

Lintel Span, mm (ft)	Lintel - 10" Thick x 16" Deep (250mm Thick x 400mm Deep), s = 8" (200mm)																	
	Uniformly Distributed Load																	
	7.5 kN/m 500 lb/ft		11 kN/m 750 lb/ft		14.5 kN/m 1000 lb/ft		18 kN/m 1250 lb/ft		21.5 kN/m 1500 lb/ft		25 kN/m 1750 lb/ft		29 kN/m 2000 lb/ft		36.5 kN/m 2500 lb/ft		43.5 kN/m 3000 lb/ft	
	Bottom Reinf. Steel	Stirrup End Dist.	Bottom Reinf. Steel	Stirrup End Dist.	Bottom Reinf. Steel	Stirrup End Dist.	Bottom Reinf. Steel	Stirrup End Dist.	Bottom Reinf. Steel	Stirrup End Dist.	Bottom Reinf. Steel	Stirrup End Dist.	Bottom Reinf. Steel	Stirrup End Dist.	Bottom Reinf. Steel	Stirrup End Dist.	Bottom Reinf. Steel	Stirrup End Dist.
900 (3)	1-10M	0	1-10M	0	1-10M	0	1-10M	0	1-10M	0	1-10M	0	1-10M	0	1-10M	0	1-10M	0
1200 (4)	1-10M	0	1-10M	0	1-10M	0	1-10M	0	1-10M	0	1-10M	0	1-15M	0	1-15M	0	1-15M	400 (16)
1500 (5)	1-10M	0	1-10M	0	1-10M	0	1-15M	0	1-15M	0	1-15M	0	1-15M	0	1-20M	400 (16)	1-20M	400 (16)
1800 (6)	1-10M	0	1-15M	0	1-15M	0	1-15M	0	1-20M	0	1-20M	0	1-20M	400 (16)	1-20M	400 (16)	1-20M	600 (24)
2400 (8)	1-15M	0	1-20M	0	1-20M	0	1-20M	0	1-20M	400 (16)	2-15M	400 (16)	2-15M	600 (24)	1-15M + 1-20M	800 (32)	2-20M	800 (32)
3000 (10)	1-20M	0	1-20M	0	2-15M	400 (16)	2-15M	400 (16)	1-15M + 1-20M	600 (24)	2-20M	800 (32)	1-10M + 2-20M	800 (32)	1-15M + 2-20M	1000 (40)	1-10M + 3-20M	1200 (48)
3600 (12)	1-20M	0	2-15M	0	1-15M + 1-20M	600 (24)	2-20M	800 (32)	1-10M + 2-20M	1000 (40)	3-20M	1000 (40)	1-10M + 3-20M	1200 (48)				
4200 (14)	2-15M	0	2-20M	400 (16)	1-10M + 2-20M	800 (32)	3-20M	1000 (40)	1-10M + 3-20M	1200 (48)								
4800 (16)	2-20M	0	1-10M + 2-20M	800 (32)	1-10M + 3-20M	1200 (48)												
5400 (18)	1-10M + 2-20M	400 (16)	1-10M + 3-20M	1000 (40)														
6000 (20)	3-20M	800 (32)																

NOTES:

1. Stirrup spacing (s) and end distance are given in "mm" and "inch"
2. Do not install more than 1-10M + 3-20M bottom bar or equivalent combination of smaller bars.
3. Bottom reinforcement located 89mm (3.5") from bottom of lintel.
4. This table to be used in conjunction with the "Lintel Design Limitations" & "Lintel Drawing".
5. Cells with zero end distance do not require stirrups, except provide a minimum of three stirrups at each end of the lintel where  $S_{a,ICF} > 0.16$ .

Lintel Span, mm (ft)	Lintel - 10" Thick x 24" Deep (250mm Thick x 600mm Deep), s = 12" (300mm)																	
	Uniformly Distributed Load																	
	7.5 kN/m 500 lb/ft		11 kN/m 750 lb/ft		14.5 kN/m 1000 lb/ft		18 kN/m 1250 lb/ft		21.5 kN/m 1500 lb/ft		29 kN/m 2000 lb/ft		36.5 kN/m 2500 lb/ft		43.5 kN/m 3000 lb/ft		51 kN/m 3500 lb/ft	
	Bottom Reinf. Steel	Stirrup End Dist.	Bottom Reinf. Steel	Stirrup End Dist.	Bottom Reinf. Steel	Stirrup End Dist.	Bottom Reinf. Steel	Stirrup End Dist.	Bottom Reinf. Steel	Stirrup End Dist.	Bottom Reinf. Steel	Stirrup End Dist.	Bottom Reinf. Steel	Stirrup End Dist.	Bottom Reinf. Steel	Stirrup End Dist.	Bottom Reinf. Steel	Stirrup End Dist.
900 (3)	1-10M	0	1-10M	0	1-10M	0	1-10M	0	1-10M	0	1-10M	0	1-10M	0	1-10M	0	1-10M	0
1200 (4)	1-10M	0	1-10M	0	1-10M	0	1-10M	0	1-10M	0	1-10M	0	1-10M	0	1-10M	0	1-15M	0
1500 (5)	1-10M	0	1-10M	0	1-10M	0	1-10M	0	1-10M	0	1-15M	0	1-15M	0	1-15M	0	1-15M	600 (24)
1800 (6)	1-10M	0	1-10M	0	1-10M	0	1-15M	0	1-15M	0	1-15M	0	1-15M	0	1-20M	600 (24)	1-20M	600 (24)
2400 (8)	1-15M	0	1-15M	0	1-15M	0	1-15M	0	1-20M	0	1-20M	600 (24)	2-15M	600 (24)	2-15M	600 (24)	2-15M	900 (36)
3000 (10)	1-15M	0	1-20M	0	1-20M	0	2-15M	0	2-15M	600 (24)	2-15M	600 (24)	1-15M + 1-20M	900 (36)	1-15M + 1-20M	900 (36)	2-20M	1200 (48)
3600 (12)	1-20M	0	2-15M	0	2-15M	0	2-15M	600 (24)	2-15M	600 (24)	2-20M	900 (36)	1-10M + 2-20M	1200 (48)	1-15M + 2-20M	1200 (48)		
4200 (14)	2-15M	0	2-15M	0	2-15M	600 (24)	1-15M + 1-20M	600 (24)	2-20M	900 (36)	1-10M + 2-20M	1200 (48)	3-20M	1500 (60)				
4800 (16)	2-15M	0	1-15M + 1-20M	0	2-20M	600 (24)	1-10M + 2-20M	900 (36)	1-15M + 2-20M	1200 (48)	1-10M + 3-20M	1500 (60)						
5400 (18)	1-15M + 1-20M	0	2-20M	600 (24)	1-10M + 2-20M	900 (36)	1-15M + 2-20M	1200 (48)	1-10M + 3-20M	1500 (60)								
6000 (20)	2-20M	0	1-10M + 2-20M	900 (36)	3-20M	1200 (48)	1-15M + 3-20M	1500 (60)										

NOTES:

1. Stirrup spacing (s) and end distance are given in "mm" and "inch"
2. Do not install more than 4-20M bottom bar or equivalent combination of smaller bars.
3. Bottom reinforcement located 89mm (3.5") from bottom of lintel.
4. This table to be used in conjunction with the "Lintel Design Limitations" & "Lintel Drawing".
5. Cells with zero end distance do not require stirrups, except provide a minimum of three stirrups at each end of the lintel where  $S_{a,ICF} > 0.16$ .

Lintel Span, mm (ft)	Lintel - 10" Thick x 32" Deep (250mm Thick x 800mm Deep), s = 16" (400mm)																	
	Uniformly Distributed Load																	
	7.5 kN/m 500 lb/ft		11 kN/m 750 lb/ft		14.5 kN/m 1000 lb/ft		18 kN/m 1250 lb/ft		21.5 kN/m 1500 lb/ft		29 kN/m 2000 lb/ft		36.5 kN/m 2500 lb/ft		43.5 kN/m 3000 lb/ft		51 kN/m 3500 lb/ft	
	Bottom Reinf. Steel	Stirrup End Dist.	Bottom Reinf. Steel	Stirrup End Dist.	Bottom Reinf. Steel	Stirrup End Dist.	Bottom Reinf. Steel	Stirrup End Dist.	Bottom Reinf. Steel	Stirrup End Dist.	Bottom Reinf. Steel	Stirrup End Dist.	Bottom Reinf. Steel	Stirrup End Dist.	Bottom Reinf. Steel	Stirrup End Dist.	Bottom Reinf. Steel	Stirrup End Dist.
900 (3)	1-10M	0	1-10M	0	1-10M	0	1-10M	0	1-10M	0	1-10M	0	1-10M	0	1-10M	0	1-10M	0
1200 (4)	1-10M	0	1-10M	0	1-10M	0	1-10M	0	1-10M	0	1-10M	0	1-10M	0	1-10M	0	1-10M	0
1500 (5)	1-10M	0	1-10M	0	1-10M	0	1-10M	0	1-10M	0	1-10M	0	1-15M	0	1-15M	0	1-15M	0
1800 (6)	1-10M	0	1-10M	0	1-10M	0	1-10M	0	1-10M	0	1-15M	0	1-15M	0	1-15M	0	1-15M	800 (32)
2400 (8)	1-10M	0	1-10M	0	1-15M	0	1-15M	0	1-15M	0	1-20M	0	2-15M	800 (32)	2-15M	800 (32)	2-15M	800 (32)
3000 (10)	1-15M	0	1-15M	0	1-15M	0	1-20M	0	1-20M	0	2-15M	800 (32)	2-15M	800 (32)	2-15M	800 (32)	1-15M + 1-20M	1200 (48)
3600 (12)	1-15M	0	1-20M	0	1-20M	0	2-15M	0	2-15M	800 (32)	2-15M	800 (32)	2-20M	1200 (48)	2-20M	1200 (48)	1-10M + 2-20M	1200 (48)
4200 (14)	1-20M	0	2-15M	0	2-15M	0	2-15M	800 (32)	2-15M	800 (32)	1-15M + 1-20M	1200 (48)	1-10M + 2-20M	1600 (64)				
4800 (16)	2-15M	0	2-15M	0	2-15M	800 (32)	1-15M + 1-20M	800 (32)	2-20M	1200 (48)	1-10M + 2-20M	1200 (48)	3-20M	1600 (64)				
5400 (18)	2-15M	0	2-15M	0	1-15M + 1-20M	800 (32)	2-20M	1200 (48)	1-10M + 2-20M	1200 (48)	3-20M	1600 (64)						
6000 (20)	2-15M	0	1-15M + 1-20M	800 (32)	1-10M + 2-20M	1200 (48)	1-15M + 2-20M	1200 (48)	3-20M	1600 (64)	1-15M + 3-20M	2000 (80)						

NOTES:

1. Stirrup spacing (s) and end distance are given in "mm" and "inch"
2. Do not install more than 4-20M bottom bar or equivalent combination of smaller bars.
3. Bottom reinforcement located 89mm (3.5") from bottom of lintel.
4. This table to be used in conjunction with the "Lintel Design Limitations" & "Lintel Drawing".
5. Cells with zero end distance do not require stirrups, except provide a minimum of three stirrups at each end of the lintel where  $S_{a,ICF} > 0.16$ .

# ICFMA

## INSULATING CONCRETE FORMS MANUFACTURERS ASSOCIATION

**Table L. 4. 12" Lintel Reinforcement with Uniformly Distributed Load**

Lintel Span, mm (ft)	Lintel - 12" Thick x 8" Deep (300mm Thick x 200mm Deep), s = 3" (75mm)																	
	Uniformly Distributed Load																	
	7.5 kN/m 500 lb/ft		11 kN/m 750 lb/ft		14.5 kN/m 1000 lb/ft		18 kN/m 1250 lb/ft		21.5 kN/m 1500 lb/ft		25.5 kN/m 1750 lb/ft		29 kN/m 2000 lb/ft		33 kN/m 2250 lb/ft		36.5 kN/m 2500 lb/ft	
	Bottom Reinf. Steel	Stirrup End Dist.	Bottom Reinf. Steel	Stirrup End Dist.	Bottom Reinf. Steel	Stirrup End Dist.	Bottom Reinf. Steel	Stirrup End Dist.	Bottom Reinf. Steel	Stirrup End Dist.	Bottom Reinf. Steel	Stirrup End Dist.	Bottom Reinf. Steel	Stirrup End Dist.	Bottom Reinf. Steel	Stirrup End Dist.	Bottom Reinf. Steel	Stirrup End Dist.
900 (3)	1-10M	0	1-10M	0	1-10M	0	1-15M	0	1-15M	0	1-15M	0	1-15M	0	1-15M	0	1-15M	0
1200 (4)	1-15M	0	1-15M	0	1-15M	0	1-15M	0	1-15M	0	1-20M	0	1-20M	150 (6)	2-15M	150 (6)	2-15M	225 (9)
1500 (5)	1-15M	0	1-15M	0	1-20M	0	1-20M	0	2-15M	150 (6)	2-15M	225 (9)	1-15M+ 1-20M	225 (9)				
1800 (6)	1-15M	0	1-20M	0	2-15M	0	2-15M	150 (6)										
2400 (8)	2-15M	0																
3000 (10)																		
3600 (12)																		
4200 (14)																		
4800 (16)																		
5400 (18)																		
6000 (20)																		

NOTES:

1. Stirrup spacing (s) and end distance are given in "mm" and "inch"
2. Do not install more than 1-15M + 1-20M bottom bar or equivalent combination of smaller bars.
3. Bottom reinforcement located 89mm (3.5") from bottom of lintel.
4. This table to be used in conjunction with the "Lintel Design Limitations" & "Lintel Drawing".
5. Cells with zero end distance do not require stirrups, except provide a minimum of three stirrups at each end of the lintel where  $S_{a,ICF} > 0.16$ .

Lintel Span, mm (ft)	Lintel - 12" Thick x 12" Deep (300mm Thick x 300mm Deep), s = 6" (150mm)																	
	Uniformly Distributed Load																	
	7.5 kN/m 500 lb/ft		11 kN/m 750 lb/ft		14.5 kN/m 1000 lb/ft		18 kN/m 1250 lb/ft		21.5 kN/m 1500 lb/ft		25.5 kN/m 1750 lb/ft		29 kN/m 2000 lb/ft		33 kN/m 2250 lb/ft		36.5 kN/m 2500 lb/ft	
	Bottom Reinf. Steel	Stirrup End Dist.	Bottom Reinf. Steel	Stirrup End Dist.	Bottom Reinf. Steel	Stirrup End Dist.	Bottom Reinf. Steel	Stirrup End Dist.	Bottom Reinf. Steel	Stirrup End Dist.	Bottom Reinf. Steel	Stirrup End Dist.	Bottom Reinf. Steel	Stirrup End Dist.	Bottom Reinf. Steel	Stirrup End Dist.	Bottom Reinf. Steel	Stirrup End Dist.
900 (3)	1-10M	0	1-10M	0	1-10M	0	1-10M	0	1-10M	0	1-10M	0	1-10M	0	1-15M	0	1-15M	0
1200 (4)	1-10M	0	1-10M	0	1-10M	0	1-15M	0	1-15M	0	1-15M	0	1-15M	0	1-15M	0	1-20M	0
1500 (5)	1-10M	0	1-15M	0	1-15M	0	1-15M	0	1-15M	0	1-20M	0	1-20M	0	1-20M	300 (12)	1-20M	300 (12)
1800 (6)	1-15M	0	1-15M	0	1-20M	0	1-20M	0	1-20M	0	1-20M	300 (12)	2-15M	300 (12)	2-15M	300 (12)	2-15M	450 (18)
2400 (8)	1-20M	0	1-20M	0	1-20M	0	2-15M	300 (12)	1-15M+ 1-20M	300 (12)	1-15M+ 1-20M	450 (18)	2-20M	600 (24)	1-10M+ 2-20M	600 (24)	1-15M+ 2-20M	750 (30)
3000 (10)	1-20M	0	2-15M	0	1-15M+ 1-20M	300 (12)	2-20M	450 (18)	1-15M+ 2-20M	600 (24)	3-20M	750 (30)						
3600 (12)	2-15M	0	2-20M	300 (12)	1-15M+ 2-20M	600 (24)												
4200 (14)	2-20M	0	3-20M	450 (18)														
4800 (16)																		
5400 (18)																		
6000 (20)																		

NOTES:

1. Stirrup spacing (s) and end distance are given in "mm" and "inch"
2. Do not install more than 3-20M bottom bar or equivalent combination of smaller bars.
3. Bottom reinforcement located 89mm (3.5") from bottom of lintel.
4. This table to be used in conjunction with the "Lintel Design Limitations" & "Lintel Drawing".
5. Cells with zero end distance do not require stirrups, except provide a minimum of three stirrups at each end of the lintel where  $S_{a,ICF} > 0.16$ .

Lintel Span, mm (ft)	Lintel - 12" Thick x 16" Deep (300mm Thick x 400mm Deep), s = 8" (200mm)																	
	Uniformly Distributed Load																	
	7.5 kN/m 500 lb/ft		11 kN/m 750 lb/ft		14.5 kN/m 1000 lb/ft		18 kN/m 1250 lb/ft		21.5 kN/m 1500 lb/ft		25.5 kN/m 1750 lb/ft		29 kN/m 2000 lb/ft		36.5 kN/m 2500 lb/ft		43.5 kN/m 3000 lb/ft	
	Bottom Reinf. Steel	Stirrup End Dist.	Bottom Reinf. Steel	Stirrup End Dist.	Bottom Reinf. Steel	Stirrup End Dist.	Bottom Reinf. Steel	Stirrup End Dist.	Bottom Reinf. Steel	Stirrup End Dist.	Bottom Reinf. Steel	Stirrup End Dist.	Bottom Reinf. Steel	Stirrup End Dist.	Bottom Reinf. Steel	Stirrup End Dist.	Bottom Reinf. Steel	Stirrup End Dist.
900 (3)	1-10M	0	1-10M	0	1-10M	0	1-10M	0	1-10M	0	1-10M	0	1-10M	0	1-10M	0	1-10M	0
1200 (4)	1-10M	0	1-10M	0	1-10M	0	1-10M	0	1-10M	0	1-10M	0	1-15M	0	1-15M	0	1-15M	0
1500 (5)	1-10M	0	1-10M	0	1-10M	0	1-15M	0	1-15M	0	1-15M	0	1-15M	0	1-20M	0	1-20M	400 (16)
1800 (6)	1-10M	0	1-15M	0	1-15M	0	1-15M	0	1-20M	0	1-20M	0	1-20M	0	1-20M	400 (16)	1-20M	400 (16)
2400 (8)	1-15M	0	1-20M	0	1-20M	0	1-20M	0	1-20M	0	2-15M	400 (16)	2-15M	400 (16)	1-15M + 1-20M	600 (24)	2-20M	800 (32)
3000 (10)	1-20M	0	1-20M	0	2-15M	0	2-15M	400 (16)	1-15M + 1-20M	400 (16)	2-20M	600 (24)	2-20M	800 (32)	1-15M + 2-20M	1000 (40)	1-10M + 3-20M	1000 (40)
3600 (12)	1-20M	0	2-15M	0	1-15M + 1-20M	400 (16)	2-20M	600 (24)	1-10M + 2-20M	800 (32)	1-15M + 2-20M	1000 (40)	1-10M + 3-20M	1000 (40)	4-20M	1200 (48)		
4200 (14)	2-15M	0	2-20M	0	1-10M + 2-20M	600 (24)	1-15M + 2-20M	800 (32)	1-10M + 3-20M	1000 (40)	4-20M	1200 (48)						
4800 (16)	2-20M	0	1-10M + 2-20M	400 (16)	1-10M + 3-20M	800 (32)	4-20M	1200 (48)										
5400 (18)	1-10M + 2-20M	0	1-10M + 3-20M	800 (32)														
6000 (20)	3-20M	400 (16)																

NOTES:

1. Stirrup spacing (s) and end distance are given in "mm" and "inch"
2. Do not install more than 4-20M bottom bar or equivalent combination of smaller bars.
3. Bottom reinforcement located 89mm (3.5") from bottom of lintel.
4. This table to be used in conjunction with the "Lintel Design Limitations" & "Lintel Drawing".
5. Cells with zero end distance do not require stirrups, except provide a minimum of three stirrups at each end of the lintel where  $S_{a,ICF} > 0.16$ .

Lintel Span, mm (ft)	Lintel - 12" Thick x 24" Deep (300mm Thick x 600mm Deep), s = 12" (300mm)																	
	Uniformly Distributed Load																	
	7.5 kN/m 500 lb/ft		11 kN/m 750 lb/ft		14.5 kN/m 1000 lb/ft		18 kN/m 1250 lb/ft		21.5 kN/m 1500 lb/ft		29 kN/m 2000 lb/ft		36.5 kN/m 2500 lb/ft		43.5 kN/m 3000 lb/ft		51 kN/m 3500 lb/ft	
	Bottom Reinf. Steel	Stirrup End Dist.	Bottom Reinf. Steel	Stirrup End Dist.	Bottom Reinf. Steel	Stirrup End Dist.	Bottom Reinf. Steel	Stirrup End Dist.	Bottom Reinf. Steel	Stirrup End Dist.	Bottom Reinf. Steel	Stirrup End Dist.	Bottom Reinf. Steel	Stirrup End Dist.	Bottom Reinf. Steel	Stirrup End Dist.	Bottom Reinf. Steel	Stirrup End Dist.
900 (3)	1-10M	0	1-10M	0	1-10M	0	1-10M	0	1-10M	0	1-10M	0	1-10M	0	1-10M	0	1-10M	0
1200 (4)	1-10M	0	1-10M	0	1-10M	0	1-10M	0	1-10M	0	1-10M	0	1-10M	0	1-10M	0	1-15M	0
1500 (5)	1-10M	0	1-10M	0	1-10M	0	1-10M	0	1-10M	0	1-15M	0	1-15M	0	1-15M	0	1-15M	0
1800 (6)	1-10M	0	1-10M	0	1-10M	0	1-15M	0	1-15M	0	1-15M	0	1-15M	0	1-20M	0	1-20M	600 (24)
2400 (8)	1-15M	0	1-15M	0	1-15M	0	1-15M	0	1-20M	0	1-20M	0	2-15M	600 (24)	2-15M	600 (24)	2-15M	600 (24)
3000 (10)	1-15M	0	1-20M	0	1-20M	0	2-15M	0	2-15M	0	2-15M	600 (24)	1-15M + 1-20M	600 (24)	1-15M + 1-20M	900 (36)	2-20M	900 (36)
3600 (12)	1-20M	0	2-15M	0	2-15M	0	2-15M	0	2-15M	600 (24)	2-20M	900 (36)	1-10M + 2-20M	900 (36)	1-15M + 2-20M	1200 (48)	3-20M	1200 (48)
4200 (14)	2-15M	0	2-15M	0	2-15M	0	1-15M + 1-20M	600 (24)	2-20M	600 (24)	1-10M + 2-20M	1200 (48)	3-20M	1200 (48)	1-15M + 3-20M	1500 (60)		
4800 (16)	2-15M	0	1-15M + 1-20M	0	2-20M	600 (24)	1-10M + 2-20M	600 (24)	1-15M + 2-20M	900 (36)	1-10M + 3-20M	1500 (60)						
5400 (18)	1-15M + 1-20M	0	2-20M	0	1-10M + 2-20M	600 (24)	3-20M	900 (36)	1-10M + 3-20M	1200 (48)								
6000 (20)	2-20M	0	1-10M + 2-20M	600 (24)	3-20M	900 (36)	1-15M + 3-20M	1200 (48)										

NOTES:

1. Stirrup spacing (s) and end distance are given in "mm" and "inch"
2. Do not install more than 4-20M bottom bar or equivalent combination of smaller bars.
3. Bottom reinforcement located 89mm (3.5") from bottom of lintel.
4. This table to be used in conjunction with the "Lintel Design Limitations" & "Lintel Drawing".
5. Cells with zero end distance do not require stirrups, except provide a minimum of three stirrups at each end of the lintel where  $S_{a,ICF} > 0.16$ .

Lintel Span, mm (ft)	Lintel - 12" Thick x 32" Deep (300mm Thick x 800mm Deep), s = 16" (400mm)																	
	Uniformly Distributed Load																	
	7.5 kN/m		11 kN/m		14.5 kN/m		18 kN/m		21.5 kN/m		29 kN/m		36.5 kN/m		43.5 kN/m		51 kN/m	
	500 lb/ft		750 lb/ft		1000 lb/ft		1250 lb/ft		1500 lb/ft		2000 lb/ft		2500 lb/ft		3000 lb/ft		3500 lb/ft	
	Bottom Reinf. Steel	Stirrup End Dist.	Bottom Reinf. Steel	Stirrup End Dist.	Bottom Reinf. Steel	Stirrup End Dist.	Bottom Reinf. Steel	Stirrup End Dist.	Bottom Reinf. Steel	Stirrup End Dist.	Bottom Reinf. Steel	Stirrup End Dist.	Bottom Reinf. Steel	Stirrup End Dist.	Bottom Reinf. Steel	Stirrup End Dist.	Bottom Reinf. Steel	Stirrup End Dist.
900 (3)	1-10M	0	1-10M	0	1-10M	0	1-10M	0	1-10M	0	1-10M	0	1-10M	0	1-10M	0	1-10M	0
1200 (4)	1-10M	0	1-10M	0	1-10M	0	1-10M	0	1-10M	0	1-10M	0	1-10M	0	1-10M	0	1-10M	0
1500 (5)	1-10M	0	1-10M	0	1-10M	0	1-10M	0	1-10M	0	1-10M	0	1-10M	0	1-15M	0	1-15M	0
1800 (6)	1-10M	0	1-10M	0	1-10M	0	1-10M	0	1-10M	0	1-15M	0	1-15M	0	1-15M	0	1-15M	0
2400 (8)	1-10M	0	1-15M	0	1-15M	0	1-15M	0	1-15M	0	1-20M	0	1-20M	0	2-15M	800 (32)	2-15M	800 (32)
3000 (10)	1-15M	0	1-15M	0	1-15M	0	1-20M	0	1-20M	0	2-15M	0	2-15M	800 (32)	1-15M + 1-20M	800 (32)	1-15M + 1-20M	800 (32)
3600 (12)	1-15M	0	1-20M	0	1-20M	0	2-15M	0	2-15M	0	1-15M + 1-20M	800 (32)	1-15M + 1-20M	800 (32)	2-20M	1200 (48)	1-10M + 2-20M	1200 (48)
4200 (14)	1-20M	0	2-15M	0	2-15M	0	1-15M + 1-20M	0	1-15M + 1-20M	800 (32)	2-20M	800 (32)	1-10M + 2-20M	1200 (48)	1-10M + 2-20M	1200 (48)		
4800 (16)	2-15M	0	1-15M + 1-20M	0	1-15M + 1-20M	0	1-15M + 1-20M	800 (32)	2-20M	800 (32)	1-10M + 2-20M	1200 (48)	3-20M	1600 (64)				
5400 (18)	1-15M + 1-20M	0	1-15M + 1-20M	0	1-15M + 1-20M	0	2-20M	800 (32)	1-10M + 2-20M	1200 (48)	3-20M	1600 (64)	1-15M + 3-20M	1600 (64)				
6000 (20)	1-15M + 1-20M	0	2-20M	0	1-10M + 2-20M	800 (32)	1-15M + 2-20M	1200 (48)	3-20M	1200 (48)	1-15M + 3-20M	1600 (64)						

NOTES:

1. Stirrup spacing (s) and end distance are given in "mm" and "inch"
2. Do not install more than 4-20M bottom bar or equivalent combination of smaller bars.
3. Bottom reinforcement located 89mm (3.5") from bottom of lintel.
4. This table to be used in conjunction with the "Lintel Design Limitations" & "Lintel Drawing".
5. Cells with zero end distance do not require stirrups, except provide a minimum of three stirrups at each end of the lintel where  $S_{a,ICF} > 0.16$ .



# INSULATING CONCRETE FORMS MANUFACTURERS ASSOCIATION

**Table L. 5. 6" Lintel Reinforcement with Concentrated Load**

Lintel Span, mm (ft)	Lintel - 6" Thick x 8" Deep (150mm Thick x 200mm Deep), s = 3" (75mm)																	
	Unfactored Point Load																	
	4 kN 800 lb		6 kN 1300 lb		8 kN 1700 lb		10 kN 2200 lb		12 kN 2600 lb		14 kN 3100 lb		16 kN 3500 lb		18 kN 4000 lb		20 kN 4400 lb	
	Bottom Reinf. Steel	Stirrups Required ?	Bottom Reinf. Steel	Stirrups Required ?	Bottom Reinf. Steel	Stirrups Required ?	Bottom Reinf. Steel	Stirrups Required ?	Bottom Reinf. Steel	Stirrups Required ?	Bottom Reinf. Steel	Stirrups Required ?	Bottom Reinf. Steel	Stirrups Required ?	Bottom Reinf. Steel	Stirrups Required ?	Bottom Reinf. Steel	Stirrups Required ?
900 (3)	1-10M	NO	1-10M	NO	1-10M	YES	1-15M	YES	1-15M	YES	1-15M	YES	1-15M	YES	1-20M	YES	1-20M	YES
1200 (4)	1-10M	NO	1-10M	NO	1-15M	YES	1-15M	YES	1-20M	YES	1-20M	YES						
1500 (5)	1-15M	NO	1-15M	NO	1-20M	YES												
1800 (6)	1-15M	NO																
2400 (8)																		
3000 (10)																		
3600 (12)																		
4200 (14)																		
4800 (16)																		
5400 (18)																		
6000 (20)																		

NOTES:

1. Stirrup spacing (s) is given in "inch" and "mm"
2. Do not install more than 1-20M bottom bar or equivalent combination of smaller bars.
3. Bottom reinforcement located 89mm (3.5") from bottom of lintel.
4. This table to be used in conjunction with the "Lintel Design Limitations" & "Lintel Drawing".
5. Beams with "NO Stirrups Required" do not require stirrups, except provide a minimum of three stirrups at each end of the lintel where  $S_{a,ICF} > 0.16$ .

Lintel Span, mm (ft)	Lintel - 6" Thick x 12" Deep (150mm Thick x 300mm Deep), s = 6" (150mm)																	
	Unfactored Point Load																	
	4 kN 800 lb		6.5 kN 1400 lb		9 kN 2000 lb		11.5 kN 2500 lb		14 kN 3100 lb		16.5 kN 3700 lb		19 kN 4200 lb		21.5 kN 4800 lb		24 kN 5300 lb	
	Bottom Reinf. Steel	Stirrups Required ?	Bottom Reinf. Steel	Stirrups Required ?	Bottom Reinf. Steel	Stirrups Required ?	Bottom Reinf. Steel	Stirrups Required ?	Bottom Reinf. Steel	Stirrups Required ?	Bottom Reinf. Steel	Stirrups Required ?	Bottom Reinf. Steel	Stirrups Required ?	Bottom Reinf. Steel	Stirrups Required ?	Bottom Reinf. Steel	Stirrups Required ?
900 (3)	1-10M	NO	1-10M	NO	1-10M	NO	1-10M	YES	1-15M	YES	1-15M	YES	1-15M	YES	1-15M	YES	1-15M	YES
1200 (4)	1-10M	NO	1-10M	NO	1-10M	NO	1-15M	YES	1-15M	YES	1-15M	YES	1-15M	YES	1-15M	YES	1-15M	YES
1500 (5)	1-10M	NO	1-15M	NO	1-15M	NO	1-15M	YES	1-15M	YES	1-15M	YES	1-20M	YES	1-20M	YES	2-15M	YES
1800 (6)	1-15M	NO	1-15M	NO	1-15M	NO	1-15M	YES	1-20M	YES	1-20M	YES	2-15M	YES				
2400 (8)	1-15M	NO	1-15M	NO	2-15M	NO	2-15M	YES	1-15M + 1-20M	YES								
3000 (10)	1-20M	NO	2-15M	NO														
3600 (12)	1-15M + 1-20M	NO																
4200 (14)																		
4800 (16)																		
5400 (18)																		
6000 (20)																		

NOTES:

1. Stirrup spacing (s) is given in "inch" and "mm"
2. Do not install more than 1-15M + 1-20M bottom bar or equivalent combination of smaller bars.
3. Bottom reinforcement located 89mm (3.5") from bottom of lintel.
4. This table to be used in conjunction with the "Lintel Design Limitations" & "Lintel Drawing".
5. Beams with "NO Stirrups Required" do not require stirrups, except provide a minimum of three stirrups at each end of the lintel where  $S_{a,ICF} > 0.16$ .



Lintel Span, mm (ft)	Lintel - 6" Thick x 16" Deep (150mm Thick x 400mm Deep), s = 8" (200mm)																	
	Unfactored Point Load																	
	4 kN 800 lb		7 kN 1500 lb		10 kN 2200 lb		13 kN 2900 lb		16 kN 3500 lb		19 kN 4200 lb		21 kN 4700 lb		24 kN 5300 lb		27 kN 6000 lb	
	Bottom Reinf. Steel	Stirrups Required ?	Bottom Reinf. Steel	Stirrups Required ?	Bottom Reinf. Steel	Stirrups Required ?	Bottom Reinf. Steel	Stirrups Required ?	Bottom Reinf. Steel	Stirrups Required ?	Bottom Reinf. Steel	Stirrups Required ?	Bottom Reinf. Steel	Stirrups Required ?	Bottom Reinf. Steel	Stirrups Required ?	Bottom Reinf. Steel	Stirrups Required ?
900 (3)	1-10M	NO	1-10M	NO	1-10M	NO	1-10M	NO	1-10M	YES	1-10M	YES	1-10M	YES	1-15M	YES	1-15M	YES
1200 (4)	1-10M	NO	1-10M	NO	1-10M	NO	1-10M	NO	1-15M	YES	1-15M	YES	1-15M	YES	1-15M	YES	1-15M	YES
1500 (5)	1-10M	NO	1-10M	NO	1-10M	NO	1-15M	YES	1-15M	YES	1-15M	YES	1-15M	YES	1-15M	YES	1-20M	YES
1800 (6)	1-10M	NO	1-15M	NO	1-15M	NO	1-15M	YES	1-15M	YES	1-15M	YES	1-20M	YES	2-15M	YES		
2400 (8)	1-15M	NO	1-15M	NO	1-15M	NO	1-20M	YES	1-20M	YES	2-15M	YES	2-20M	YES				
3000 (10)	1-15M	NO	1-20M	NO	2-15M	NO	2-15M	YES	1-15M + 1-20M	YES								
3600 (12)	1-20M	NO	2-15M	NO	1-15M + 1-20M	NO	1-10M + 2-20M	YES	1-15M + 2-20M	YES								
4200 (14)	2-15M	NO	2-20M	NO	1-15M + 2-20M	YES												
4800 (16)	2-20M	NO	1-15M + 2-20M	NO														
5400 (18)	1-15M + 2-20M	NO																
6000 (20)																		

NOTES:

1. Stirrup spacing (s) is given in "inch" and "mm"
2. Do not install more than 1-15M + 2-20M bottom bar or equivalent combination of smaller bars.
3. Bottom reinforcement located 89mm (3.5") from bottom of lintel.
4. This table to be used in conjunction with the "Lintel Design Limitations" & "Lintel Drawing".
5. Beams with "NO Stirrups Required" do not require stirrups, except provide a minimum of three stirrups at each end of the lintel where  $S_{a,ICF} > 0.16$ .

Lintel Span, mm (ft)	Lintel - 6" Thick x 24" Deep (150mm Thick x 600mm Deep), s = 12" (300mm)																	
	Unfactored Point Load																	
	4 kN 800 lb		8 kN 1700 lb		12 kN 2600 lb		16 kN 3500 lb		20 kN 4400 lb		24 kN 5300 lb		28 kN 6200 lb		32 kN 7100 lb		36 kN 8000 lb	
	Bottom Reinf. Steel	Stirrups Required ?	Bottom Reinf. Steel	Stirrups Required ?	Bottom Reinf. Steel	Stirrups Required ?	Bottom Reinf. Steel	Stirrups Required ?	Bottom Reinf. Steel	Stirrups Required ?	Bottom Reinf. Steel	Stirrups Required ?	Bottom Reinf. Steel	Stirrups Required ?	Bottom Reinf. Steel	Stirrups Required ?	Bottom Reinf. Steel	Stirrups Required ?
900 (3)	1-10M	NO	1-10M	NO	1-10M	NO	1-10M	NO	1-10M	YES	1-10M	YES	1-10M	YES	1-10M	YES	1-15M	YES
1200 (4)	1-10M	NO	1-10M	NO	1-10M	NO	1-10M	NO	1-10M	YES	1-10M	YES	1-15M	YES	1-15M	YES	1-15M	YES
1500 (5)	1-10M	NO	1-10M	NO	1-10M	NO	1-10M	NO	1-15M	YES	1-15M	YES	1-15M	YES	1-15M	YES	1-15M	YES
1800 (6)	1-10M	NO	1-10M	NO	1-10M	NO	1-15M	NO	1-15M	YES	1-15M	YES	1-15M	YES	1-15M	YES	1-20M	YES
2400 (8)	1-10M	NO	1-15M	NO	1-15M	NO	1-15M	NO	1-15M	YES	1-15M	YES	1-20M	YES	2-15M	YES	2-15M	YES
3000 (10)	1-15M	NO	1-15M	NO	1-15M	NO	1-20M	YES	1-20M	YES	2-15M	YES	1-15M + 1-20M	YES	2-20M	YES		
3600 (12)	1-15M	NO	1-15M	NO	1-20M	NO	2-15M	YES	2-15M	YES	2-20M	YES	1-10M + 2-20M	YES				
4200 (14)	1-20M	NO	1-20M	NO	2-15M	NO	1-15M + 1-20M	YES	2-20M	YES	1-15M + 2-20M	YES						
4800 (16)	1-20M	NO	2-15M	NO	1-15M + 1-20M	NO	1-10M + 2-20M	YES	1-15M + 2-20M	YES	1-15M + 3-20M	YES						
5400 (18)	2-15M	NO	2-20M	NO	1-10M + 2-20M	YES	3-20M	YES	1-15M + 3-20M	YES								
6000 (20)	1-15M + 1-20M	NO	1-10M + 2-20M	NO	3-20M	YES	1-15M + 3-20M	YES										

NOTES:

1. Stirrup spacing (s) is given in "inch" and "mm"
2. Do not install more than 4-20M bottom bar or equivalent combination of smaller bars.
3. Bottom reinforcement located 89mm (3.5") from bottom of lintel.
4. This table to be used in conjunction with the "Lintel Design Limitations" & "Lintel Drawing".
5. Beams with "NO Stirrups Required" do not require stirrups, except provide a minimum of three stirrups at each end of the lintel where  $S_{a,ICF} > 0.16$ .

Lintel Span, mm (ft)	Lintel - 6" Thick x 32" Deep (150mm Thick x 800mm Deep), s = 16" (400mm)																	
	Unfactored Point Load																	
	4 kN 800 lb		9 kN 2000 lb		14 kN 3100 lb		19 kN 4200 lb		24 kN 5300 lb		29 kN 6500 lb		34 kN 7600 lb		39 kN 8700 lb		44 kN 9800 lb	
	Bottom Reinf. Steel	Stirrups Required ?	Bottom Reinf. Steel	Stirrups Required ?	Bottom Reinf. Steel	Stirrups Required ?	Bottom Reinf. Steel	Stirrups Required ?	Bottom Reinf. Steel	Stirrups Required ?	Bottom Reinf. Steel	Stirrups Required ?	Bottom Reinf. Steel	Stirrups Required ?	Bottom Reinf. Steel	Stirrups Required ?	Bottom Reinf. Steel	Stirrups Required ?
900 (3)	1-10M	NO	1-10M	NO	1-10M	NO	1-10M	NO	1-10M	YES	1-10M	YES	1-10M	YES	1-10M	YES	1-10M	YES
1200 (4)	1-10M	NO	1-10M	NO	1-10M	NO	1-10M	NO	1-10M	YES	1-10M	YES	1-10M	YES	1-15M	YES	1-15M	YES
1500 (5)	1-10M	NO	1-10M	NO	1-10M	NO	1-10M	NO	1-10M	YES	1-15M	YES	1-15M	YES	1-15M	YES	1-15M	YES
1800 (6)	1-10M	NO	1-10M	NO	1-10M	NO	1-10M	NO	1-15M	YES	1-15M	YES	1-15M	YES	1-15M	YES	1-20M	YES
2400 (8)	1-10M	NO	1-10M	NO	1-15M	NO	1-15M	NO	1-15M	YES	1-20M	YES	1-20M	YES	1-20M	YES	1-15M + 1-20M	YES
3000 (10)	1-15M	NO	1-15M	NO	1-15M	NO	1-20M	YES	1-20M	YES	1-20M	YES	2-15M	YES				
3600 (12)	1-15M	NO	1-20M	NO	1-20M	NO	1-20M	YES	2-15M	YES	1-15M + 1-20M	YES						
4200 (14)	1-20M	NO	1-20M	NO	1-20M	NO	2-15M	YES	1-15M + 1-20M	YES								
4800 (16)	1-20M	NO	1-20M	NO	2-15M	NO	1-15M + 1-20M	YES	1-10M + 2-20M	YES								
5400 (18)	1-20M	NO	2-15M	NO	1-15M + 1-20M	NO	2-20M	YES										
6000 (20)	2-15M	NO	1-15M + 1-20M	NO	2-20M	YES	1-10M + 2-20M	YES										

NOTES:

1. Stirrup spacing (s) is given in "inch" and "mm"
2. Do not install more than 4-20M bottom bar or equivalent combination of smaller bars.
3. Bottom reinforcement located 89mm (3.5") from bottom of lintel.
4. This table to be used in conjunction with the "Lintel Design Limitations" & "Lintel Drawing".
5. Beams with "NO Stirrups Required" do not require stirrups, except provide a minimum of three stirrups at each end of the lintel where  $S_{a,ICF} > 0.16$ .

# ICFMA

## INSULATING CONCRETE FORMS MANUFACTURERS ASSOCIATION

**Table L. 6. 8" Lintel Reinforcement with Concentrated Load**

Lintel Span, mm (ft)	<b>Lintel - 8" Thick x 8" Deep (200mm Thick x 200mm Deep), s = 3" (75mm)</b>																	
	Unfactored Point Load																	
	4 kN		6 kN		8 kN		10 kN		12 kN		14 kN		16 kN		18 kN		20 kN	
	800 lb		1300 lb		1700 lb		2200 lb		2600 lb		3100 lb		3500 lb		4000 lb		4400 lb	
	Bottom Reinf. Steel	Stirrups Required ?	Bottom Reinf. Steel	Stirrups Required ?	Bottom Reinf. Steel	Stirrups Required ?	Bottom Reinf. Steel	Stirrups Required ?	Bottom Reinf. Steel	Stirrups Required ?	Bottom Reinf. Steel	Stirrups Required ?	Bottom Reinf. Steel	Stirrups Required ?	Bottom Reinf. Steel	Stirrups Required ?	Bottom Reinf. Steel	Stirrups Required ?
900 (3)	1-10M	NO	1-10M	NO	1-10M	NO	1-15M	YES	1-15M	YES	1-15M	YES	1-15M	YES	1-20M	YES	1-20M	YES
1200 (4)	1-15M	NO	1-15M	NO	1-15M	NO	1-15M	YES	1-20M	YES	1-20M	YES						
1500 (5)	1-15M	NO	1-15M	NO	1-20M	NO	1-20M	YES										
1800 (6)	1-15M	NO	1-20M	NO														
2400 (8)																		
3000 (10)																		
3600 (12)																		
4200 (14)																		
4800 (16)																		
5400 (18)																		
6000 (20)																		

**NOTES:**

1. Stirrup spacing (s) is given in "inch" and "mm"
2. Do not install more than 1-20M bottom bar or equivalent combination of smaller bars.
3. Bottom reinforcement located 89mm (3.5") from bottom of lintel.
4. This table to be used in conjunction with the "Lintel Design Limitations" & "Lintel Drawing".
5. Beams with "NO Stirrups Required" do not require stirrups, except provide a minimum of three stirrups at each end of the lintel where  $S_{a,ICF} > 0.16$ .

Lintel Span, mm (ft)	<b>Lintel - 8" Thick x 12" Deep (200mm Thick x 300mm Deep), s = 6" (150mm)</b>																	
	Unfactored Point Load																	
	4 kN		6.5 kN		9 kN		11.5 kN		14 kN		16.5 kN		19 kN		21.5 kN		24 kN	
	800 lb		1400 lb		2000 lb		2500 lb		3100 lb		3700 lb		4200 lb		4800 lb		5300 lb	
	Bottom Reinf. Steel	Stirrups Required ?	Bottom Reinf. Steel	Stirrups Required ?	Bottom Reinf. Steel	Stirrups Required ?	Bottom Reinf. Steel	Stirrups Required ?	Bottom Reinf. Steel	Stirrups Required ?	Bottom Reinf. Steel	Stirrups Required ?	Bottom Reinf. Steel	Stirrups Required ?	Bottom Reinf. Steel	Stirrups Required ?	Bottom Reinf. Steel	Stirrups Required ?
900 (3)	1-10M	NO	1-10M	NO	1-10M	NO	1-10M	NO	1-15M	NO	1-15M	YES	1-15M	YES	1-15M	YES	1-15M	YES
1200 (4)	1-10M	NO	1-10M	NO	1-10M	NO	1-15M	NO	1-15M	YES	1-15M	YES	1-15M	YES	1-15M	YES	1-15M	YES
1500 (5)	1-10M	NO	1-10M	NO	1-15M	NO	1-15M	NO	1-15M	YES	1-15M	YES	1-20M	YES	1-20M	YES	1-15M + 1-20M	YES
1800 (6)	1-15M	NO	1-15M	NO	1-15M	NO	1-15M	NO	1-20M	YES	1-20M	YES	2-15M	YES	2-15M	YES	1-15M + 1-20M	YES
2400 (8)	1-15M	NO	1-20M	NO	1-20M	NO	2-15M	NO	1-15M + 1-20M	YES	2-20M	YES						
3000 (10)	1-20M	NO	2-15M	NO	2-20M	NO												
3600 (12)	1-15M + 1-20M	NO																
4200 (14)																		
4800 (16)																		
5400 (18)																		
6000 (20)																		

**NOTES:**

1. Stirrup spacing (s) is given in "inch" and "mm"
2. Do not install more than 2-20M bottom bar or equivalent combination of smaller bars.
3. Bottom reinforcement located 89mm (3.5") from bottom of lintel.
4. This table to be used in conjunction with the "Lintel Design Limitations" & "Lintel Drawing".
5. Beams with "NO Stirrups Required" do not require stirrups, except provide a minimum of three stirrups at each end of the lintel where  $S_{a,ICF} > 0.16$ .

Lintel Span, mm (ft)	Lintel - 8" Thick x 16" Deep (200mm Thick x 400mm Deep), s = 8" (200mm)																	
	Unfactored Point Load																	
	4 kN 800 lb		7 kN 1500 lb		10 kN 2200 lb		13 kN 2900 lb		16 kN 3500 lb		19 kN 4200 lb		21 kN 4700 lb		24 kN 5300 lb		27 kN 6000 lb	
	Bottom Reinf. Steel	Stirrups Required ?	Bottom Reinf. Steel	Stirrups Required ?	Bottom Reinf. Steel	Stirrups Required ?	Bottom Reinf. Steel	Stirrups Required ?	Bottom Reinf. Steel	Stirrups Required ?	Bottom Reinf. Steel	Stirrups Required ?	Bottom Reinf. Steel	Stirrups Required ?	Bottom Reinf. Steel	Stirrups Required ?	Bottom Reinf. Steel	Stirrups Required ?
900 (3)	1-10M	NO	1-10M	NO	1-10M	NO	1-10M	NO	1-10M	NO	1-10M	YES	1-10M	YES	1-15M	YES	1-15M	YES
1200 (4)	1-10M	NO	1-10M	NO	1-10M	NO	1-10M	NO	1-15M	NO	1-15M	YES	1-15M	YES	1-15M	YES	1-15M	YES
1500 (5)	1-10M	NO	1-10M	NO	1-10M	NO	1-15M	NO	1-15M	NO	1-15M	YES	1-15M	YES	1-15M	YES	1-20M	YES
1800 (6)	1-10M	NO	1-15M	NO	1-15M	NO	1-15M	NO	1-15M	NO	1-15M	YES	1-20M	YES	2-15M	YES	2-15M	YES
2400 (8)	1-15M	NO	1-15M	NO	1-15M	NO	1-20M	NO	1-20M	YES	2-15M	YES	1-15M + 1-20M	YES	2-20M	YES		
3000 (10)	1-15M	NO	1-15M	NO	2-15M	NO	2-15M	NO	1-15M + 1-20M	YES	2-20M	YES	1-15M + 2-20M	YES				
3600 (12)	1-20M	NO	2-15M	NO	1-15M + 1-20M	NO	2-20M	NO	1-10M + 2-20M	YES								
4200 (14)	2-15M	NO	2-20M	NO	1-10M + 2-20M	NO	3-20M	NO										
4800 (16)	2-20M	NO	1-15M + 2-20M	NO														
5400 (18)	1-10M + 2-20M	NO																
6000 (20)	3-20M	NO																

NOTES:

1. Stirrup spacing (s) is given in "inch" and "mm"
2. Do not install more than 3-20M bottom bar or equivalent combination of smaller bars.
3. Bottom reinforcement located 89mm (3.5") from bottom of lintel.
4. This table to be used in conjunction with the "Lintel Design Limitations" & "Lintel Drawing".
5. Beams with "NO Stirrups Required" do not require stirrups, except provide a minimum of three stirrups at each end of the lintel where  $S_{a,ICF} > 0.16$ .

Lintel Span, mm (ft)	Lintel - 8" Thick x 24" Deep (200mm Thick x 600mm Deep), s = 12" (300mm)																	
	Unfactored Point Load																	
	4 kN 800 lb		8 kN 1700 lb		12 kN 2600 lb		16 kN 3500 lb		20 kN 4400 lb		24 kN 5300 lb		28 kN 6200 lb		32 kN 7100 lb		36 kN 8000 lb	
	Bottom Reinf. Steel	Stirrups Required ?	Bottom Reinf. Steel	Stirrups Required ?	Bottom Reinf. Steel	Stirrups Required ?	Bottom Reinf. Steel	Stirrups Required ?	Bottom Reinf. Steel	Stirrups Required ?	Bottom Reinf. Steel	Stirrups Required ?	Bottom Reinf. Steel	Stirrups Required ?	Bottom Reinf. Steel	Stirrups Required ?	Bottom Reinf. Steel	Stirrups Required ?
900 (3)	1-10M	NO	1-10M	NO	1-10M	NO	1-10M	NO	1-10M	NO	1-10M	NO	1-10M	YES	1-10M	YES	1-15M	YES
1200 (4)	1-10M	NO	1-10M	NO	1-10M	NO	1-10M	NO	1-10M	NO	1-10M	NO	1-15M	YES	1-15M	YES	1-15M	YES
1500 (5)	1-10M	NO	1-10M	NO	1-10M	NO	1-10M	NO	1-15M	NO	1-15M	NO	1-15M	YES	1-15M	YES	1-15M	YES
1800 (6)	1-10M	NO	1-10M	NO	1-10M	NO	1-15M	NO	1-15M	NO	1-15M	NO	1-15M	YES	1-20M	YES	1-20M	YES
2400 (8)	1-10M	NO	1-15M	NO	1-15M	NO	1-15M	NO	1-20M	NO	1-20M	YES	1-20M	YES	2-15M	YES	2-15M	YES
3000 (10)	1-15M	NO	1-20M	NO	1-20M	NO	1-20M	NO	1-20M	NO	2-15M	YES	1-15M + 1-20M	YES	2-20M	YES		
3600 (12)	1-20M	NO	1-20M	NO	1-20M	NO	2-15M	NO	2-15M	NO	1-15M + 1-20M	YES	1-10M + 2-20M	YES				
4200 (14)	1-20M	NO	2-15M	NO	2-15M	NO	1-15M + 1-20M	NO	2-20M	YES	1-15M + 2-20M	YES	1-10M + 3-20M	YES				
4800 (16)	2-15M	NO	2-15M	NO	2-20M	NO	1-10M + 2-20M	NO	1-15M + 2-20M	YES	1-10M + 3-20M	YES						
5400 (18)	2-15M	NO	2-20M	NO	1-10M + 2-20M	NO	1-15M + 2-20M	NO	1-10M + 3-20M	YES								
6000 (20)	1-15M + 1-20M	NO	1-10M + 2-20M	NO	3-20M	NO	1-15M + 3-20M	NO										

NOTES:

1. Stirrup spacing (s) is given in "inch" and "mm"
2. Do not install more than 4-20M bottom bar or equivalent combination of smaller bars.
3. Bottom reinforcement located 89mm (3.5") from bottom of lintel.
4. This table to be used in conjunction with the "Lintel Design Limitations" & "Lintel Drawing".
5. Beams with "NO Stirrups Required" do not require stirrups, except provide a minimum of three stirrups at each end of the lintel where  $S_{a,ICF} > 0.16$ .

Lintel Span, mm (ft)	Lintel - 8" Thick x 32" Deep (200mm Thick x 800mm Deep), s = 16" (400mm)																	
	Unfactored Point Load																	
	4 kN 800 lb		9 kN 2000 lb		14 kN 3100 lb		19 kN 4200 lb		24 kN 5300 lb		29 kN 6500 lb		34 kN 7600 lb		39 kN 8700 lb		44 kN 9800 lb	
	Bottom Reinf. Steel	Stirrups Required ?	Bottom Reinf. Steel	Stirrups Required ?	Bottom Reinf. Steel	Stirrups Required ?	Bottom Reinf. Steel	Stirrups Required ?	Bottom Reinf. Steel	Stirrups Required ?	Bottom Reinf. Steel	Stirrups Required ?	Bottom Reinf. Steel	Stirrups Required ?	Bottom Reinf. Steel	Stirrups Required ?	Bottom Reinf. Steel	Stirrups Required ?
900 (3)	1-10M	NO	1-10M	NO	1-10M	NO	1-10M	NO	1-10M	NO	1-10M	NO	1-10M	YES	1-10M	YES	1-10M	YES
1200 (4)	1-10M	NO	1-10M	NO	1-10M	NO	1-10M	NO	1-10M	NO	1-10M	NO	1-10M	YES	1-15M	YES	1-15M	YES
1500 (5)	1-10M	NO	1-10M	NO	1-10M	NO	1-10M	NO	1-10M	NO	1-15M	NO	1-15M	YES	1-15M	YES	1-15M	YES
1800 (6)	1-10M	NO	1-10M	NO	1-10M	NO	1-10M	NO	1-15M	NO	1-15M	NO	1-15M	YES	1-15M	YES	1-15M	YES
2400 (8)	1-10M	NO	1-10M	NO	1-15M	NO	1-15M	NO	1-15M	NO	1-20M	YES	2-15M	YES	2-15M	YES	2-15M	YES
3000 (10)	1-15M	NO	1-15M	NO	1-15M	NO	1-20M	NO	2-15M	NO	2-15M	YES	2-15M	YES	1-15M + 1-20M	YES		
3600 (12)	1-15M	NO	1-20M	NO	1-20M	NO	2-15M	NO	2-15M	NO	1-15M + 1-20M	YES	2-20M	YES				
4200 (14)	1-20M	NO	2-15M	NO	2-15M	NO	2-15M	NO	1-15M + 1-20M	NO	1-10M + 2-20M	YES						
4800 (16)	2-15M	NO	2-15M	NO	2-15M	NO	1-15M + 1-20M	NO	1-10M + 2-20M	YES								
5400 (18)	2-15M	NO	2-15M	NO	1-15M + 1-20M	NO	2-20M	NO	3-20M	YES								
6000 (20)	2-15M	NO	1-15M + 1-20M	NO	2-20M	NO	1-10M + 2-20M	NO										

NOTES:

1. Stirrup spacing (s) is given in "inch" and "mm"
2. Do not install more than 4-20M bottom bar or equivalent combination of smaller bars.
3. Bottom reinforcement located 89mm (3.5") from bottom of lintel.
4. This table to be used in conjunction with the "Lintel Design Limitations" & "Lintel Drawing".
5. Beams with "NO Stirrups Required" do not require stirrups, except provide a minimum of three stirrups at each end of the lintel where  $S_{a,ICF} > 0.16$ .

# ICFMA

## INSULATING CONCRETE FORMS MANUFACTURERS ASSOCIATION

**Table L. 7. 10'' Lintel Reinforcement with Concentrated Load**

Lintel Span, mm (ft)	<b>Lintel - 10'' Thick x 8'' Deep (250mm Thick x 200mm Deep), s = 3'' (75mm)</b>																	
	Unfactored Point Load																	
	4 kN 800 lb		6 kN 1300 lb		8 kN 1700 lb		10 kN 2200 lb		12 kN 2600 lb		14 kN 3100 lb		16 kN 3500 lb		18 kN 4000 lb		20 kN 4400 lb	
	Bottom Reinf. Steel	Stirrups Required ?	Bottom Reinf. Steel	Stirrups Required ?	Bottom Reinf. Steel	Stirrups Required ?	Bottom Reinf. Steel	Stirrups Required ?	Bottom Reinf. Steel	Stirrups Required ?	Bottom Reinf. Steel	Stirrups Required ?	Bottom Reinf. Steel	Stirrups Required ?	Bottom Reinf. Steel	Stirrups Required ?	Bottom Reinf. Steel	Stirrups Required ?
900 (3)	1-10M	NO	1-10M	NO	1-15M	NO	1-15M	NO	1-15M	NO	1-15M	YES	1-15M	YES	1-15M	YES	1-20M	YES
1200 (4)	1-15M	NO	1-15M	NO	1-15M	NO	1-15M	NO	1-15M	NO	1-20M	YES	1-20M	YES	2-15M	YES	2-15M	YES
1500 (5)	1-15M	NO	1-15M	NO	1-20M	NO	1-20M	NO	2-15M	NO								
1800 (6)	1-15M	NO	1-20M	NO	2-15M	NO												
2400 (8)	2-15M	NO																
3000 (10)																		
3600 (12)																		
4200 (14)																		
4800 (16)																		
5400 (18)																		
6000 (20)																		

**NOTES:**

1. Stirrup spacing (s) is given in "inch" and "mm"
2. Do not install more than 2-15M bottom bar or equivalent combination of smaller bars.
3. Bottom reinforcement located 89mm (3.5") from bottom of lintel.
4. This table to be used in conjunction with the "Lintel Design Limitations" & "Lintel Drawing".
5. Beams with "NO Stirrups Required" do not require stirrups, except provide a minimum of three stirrups at each end of the lintel where  $S_{a,ICF} > 0.16$ .

Lintel Span, mm (ft)	<b>Lintel - 10'' Thick x 12'' Deep (250mm Thick x 300mm Deep), s = 6'' (150mm)</b>																	
	Unfactored Point Load																	
	4 kN 800 lb		6.5 kN 1400 lb		9 kN 2000 lb		11.5 kN 2500 lb		14 kN 3100 lb		16.5 kN 3700 lb		19 kN 4200 lb		21.5 kN 4800 lb		24 kN 5300 lb	
	Bottom Reinf. Steel	Stirrups Required ?	Bottom Reinf. Steel	Stirrups Required ?	Bottom Reinf. Steel	Stirrups Required ?	Bottom Reinf. Steel	Stirrups Required ?	Bottom Reinf. Steel	Stirrups Required ?	Bottom Reinf. Steel	Stirrups Required ?	Bottom Reinf. Steel	Stirrups Required ?	Bottom Reinf. Steel	Stirrups Required ?	Bottom Reinf. Steel	Stirrups Required ?
900 (3)	1-10M	NO	1-10M	NO	1-10M	NO	1-10M	NO	1-15M	NO	1-15M	NO	1-15M	YES	1-15M	YES	1-15M	YES
1200 (4)	1-10M	NO	1-10M	NO	1-10M	NO	1-15M	NO	1-15M	NO	1-15M	NO	1-15M	YES	1-15M	YES	1-15M	YES
1500 (5)	1-10M	NO	1-15M	NO	1-15M	NO	1-15M	NO	1-15M	NO	1-15M	NO	1-20M	YES	1-20M	YES	2-15M	YES
1800 (6)	1-15M	NO	1-15M	NO	1-15M	NO	1-15M	NO	1-20M	NO	1-20M	NO	2-15M	YES	2-15M	YES	1-15M + 1-20M	YES
2400 (8)	1-15M	NO	1-20M	NO	1-20M	NO	2-15M	NO	1-15M + 1-20M	NO	2-20M	YES	1-10M + 2-20M	YES				
3000 (10)	1-20M	NO	2-15M	NO	1-15M + 1-20M	NO	1-10M + 2-20M	NO										
3600 (12)	1-15M + 1-20M	NO	2-20M	NO														
4200 (14)	1-10M + 2-20M	NO																
4800 (16)																		
5400 (18)																		
6000 (20)																		

**NOTES:**

1. Stirrup spacing (s) is given in "inch" and "mm"
2. Do not install more than 1-10M + 2-20M bottom bar or equivalent combination of smaller bars.
3. Bottom reinforcement located 89mm (3.5") from bottom of lintel.
4. This table to be used in conjunction with the "Lintel Design Limitations" & "Lintel Drawing".
5. Beams with "NO Stirrups Required" do not require stirrups, except provide a minimum of three stirrups at each end of the lintel where  $S_{a,ICF} > 0.16$ .

Lintel Span, mm (ft)	Lintel - 10" Thick x 16" Deep (250mm Thick x 400mm Deep), s = 8" (200mm)																	
	Unfactored Point Load																	
	4 kN 800 lb		7 kN 1500 lb		10 kN 2200 lb		13 kN 2900 lb		16 kN 3500 lb		19 kN 4200 lb		21 kN 4700 lb		24 kN 5300 lb		27 kN 6000 lb	
	Bottom Reinf. Steel	Stirrups Required ?	Bottom Reinf. Steel	Stirrups Required ?	Bottom Reinf. Steel	Stirrups Required ?	Bottom Reinf. Steel	Stirrups Required ?	Bottom Reinf. Steel	Stirrups Required ?	Bottom Reinf. Steel	Stirrups Required ?	Bottom Reinf. Steel	Stirrups Required ?	Bottom Reinf. Steel	Stirrups Required ?	Bottom Reinf. Steel	Stirrups Required ?
900 (3)	1-10M	NO	1-10M	NO	1-10M	NO	1-10M	NO	1-10M	NO	1-10M	NO	1-10M	NO	1-15M	YES	1-15M	YES
1200 (4)	1-10M	NO	1-10M	NO	1-10M	NO	1-10M	NO	1-15M	NO	1-15M	NO	1-15M	NO	1-15M	YES	1-15M	YES
1500 (5)	1-10M	NO	1-10M	NO	1-10M	NO	1-15M	NO	1-15M	NO	1-15M	NO	1-20M	NO	1-20M	YES	1-20M	YES
1800 (6)	1-10M	NO	1-15M	NO	1-15M	NO	1-15M	NO	1-20M	NO	1-20M	NO	1-20M	NO	2-15M	YES	2-15M	YES
2400 (8)	1-15M	NO	1-20M	NO	1-20M	NO	1-20M	NO	1-20M	NO	2-15M	NO	1-15M + 1-20M	YES	2-20M	YES	1-10M + 2-20M	YES
3000 (10)	1-20M	NO	1-20M	NO	2-15M	NO	2-15M	NO	1-15M + 1-20M	NO	2-20M	NO	1-15M + 2-20M	YES	1-10M + 3-20M	YES		
3600 (12)	1-20M	NO	2-15M	NO	1-15M + 1-20M	NO	2-20M	NO	1-10M + 2-20M	NO	1-10M + 3-20M	YES						
4200 (14)	2-15M	NO	2-20M	NO	1-10M + 2-20M	NO	3-20M	NO	1-15M + 3-20M	NO								
4800 (16)	2-20M	NO	1-10M + 2-20M	NO	1-10M + 3-20M	NO												
5400 (18)	1-10M + 2-20M	NO	1-10M + 3-20M	NO														
6000 (20)	3-20M	NO	1-10M + 3-20M	NO														

NOTES:

1. Stirrup spacing (s) is given in "inch" and "mm"
2. Do not install more than 1-10M + 3-20M bottom bar or equivalent combination of smaller bars.
3. Bottom reinforcement located 89mm (3.5") from bottom of lintel.
4. This table to be used in conjunction with the "Lintel Design Limitations" & "Lintel Drawing".
5. Beams with "NO Stirrups Required" do not require stirrups, except provide a minimum of three stirrups at each end of the lintel where  $S_{a,ICF} > 0.16$ .

Lintel Span, mm (ft)	Lintel - 10" Thick x 24" Deep (250mm Thick x 600mm Deep), s = 12" (300mm)																	
	Unfactored Point Load																	
	4 kN 800 lb		8 kN 1700 lb		12 kN 2600 lb		16 kN 3500 lb		20 kN 4400 lb		24 kN 5300 lb		28 kN 6200 lb		32 kN 7100 lb		36 kN 8000 lb	
	Bottom Reinf. Steel	Stirrups Required ?	Bottom Reinf. Steel	Stirrups Required ?	Bottom Reinf. Steel	Stirrups Required ?	Bottom Reinf. Steel	Stirrups Required ?	Bottom Reinf. Steel	Stirrups Required ?	Bottom Reinf. Steel	Stirrups Required ?	Bottom Reinf. Steel	Stirrups Required ?	Bottom Reinf. Steel	Stirrups Required ?	Bottom Reinf. Steel	Stirrups Required ?
900 (3)	1-10M	NO	1-10M	NO	1-10M	NO	1-10M	NO	1-10M	NO	1-10M	NO	1-10M	NO	1-10M	NO	1-15M	YES
1200 (4)	1-10M	NO	1-10M	NO	1-10M	NO	1-10M	NO	1-10M	NO	1-10M	NO	1-15M	NO	1-15M	NO	1-15M	YES
1500 (5)	1-10M	NO	1-10M	NO	1-10M	NO	1-10M	NO	1-15M	NO	1-15M	NO	1-15M	NO	1-15M	YES	1-15M	YES
1800 (6)	1-10M	NO	1-10M	NO	1-10M	NO	1-15M	NO	1-15M	NO	1-15M	NO	1-15M	NO	1-20M	YES	1-20M	YES
2400 (8)	1-15M	NO	1-15M	NO	1-15M	NO	1-15M	NO	1-20M	NO	1-20M	NO	2-15M	NO	2-15M	YES	2-15M	YES
3000 (10)	1-15M	NO	1-20M	NO	1-20M	NO	2-15M	NO	2-15M	NO	2-15M	NO	1-15M + 1-20M	NO	2-20M	YES	1-10M + 2-20M	YES
3600 (12)	1-20M	NO	2-15M	NO	2-15M	NO	2-15M	NO	2-15M	NO	2-20M	NO	1-10M + 2-20M	YES	1-15M + 2-20M	YES		
4200 (14)	2-15M	NO	2-15M	NO	2-15M	NO	1-15M + 1-20M	NO	2-20M	NO	1-10M + 2-20M	NO	3-20M	YES				
4800 (16)	2-15M	NO	1-15M + 1-20M	NO	2-20M	NO	1-10M + 2-20M	NO	1-15M + 2-20M	NO	1-10M + 3-20M	NO						
5400 (18)	1-15M + 1-20M	NO	2-20M	NO	1-10M + 2-20M	NO	1-15M + 2-20M	NO	1-10M + 3-20M	NO								
6000 (20)	2-20M	NO	1-10M + 2-20M	NO	3-20M	NO	1-15M + 3-20M	NO										

NOTES:

1. Stirrup spacing (s) is given in "inch" and "mm"
2. Do not install more than 4-20M bottom bar or equivalent combination of smaller bars.
3. Bottom reinforcement located 89mm (3.5") from bottom of lintel.
4. This table to be used in conjunction with the "Lintel Design Limitations" & "Lintel Drawing".
5. Beams with "NO Stirrups Required" do not require stirrups, except provide a minimum of three stirrups at each end of the lintel where  $S_{a,ICF} > 0.16$ .

Lintel Span, mm (ft)	Lintel - 10" Thick x 32" Deep (250mm Thick x 800mm Deep), s = 16" (400mm)																	
	Unfactored Point Load																	
	4 kN 800 lb		9 kN 2000 lb		14 kN 3100 lb		19 kN 4200 lb		24 kN 5300 lb		29 kN 6500 lb		34 kN 7600 lb		39 kN 8700 lb		44 kN 9800 lb	
	Bottom Reinf. Steel	Stirrups Required ?	Bottom Reinf. Steel	Stirrups Required ?	Bottom Reinf. Steel	Stirrups Required ?	Bottom Reinf. Steel	Stirrups Required ?	Bottom Reinf. Steel	Stirrups Required ?	Bottom Reinf. Steel	Stirrups Required ?	Bottom Reinf. Steel	Stirrups Required ?	Bottom Reinf. Steel	Stirrups Required ?	Bottom Reinf. Steel	Stirrups Required ?
900 (3)	1-10M	NO	1-10M	NO	1-10M	NO	1-10M	NO	1-10M	NO	1-10M	NO	1-10M	NO	1-10M	NO	1-10M	YES
1200 (4)	1-10M	NO	1-10M	NO	1-10M	NO	1-10M	NO	1-10M	NO	1-10M	NO	1-10M	NO	1-15M	NO	1-15M	YES
1500 (5)	1-10M	NO	1-10M	NO	1-10M	NO	1-10M	NO	1-10M	NO	1-15M	NO	1-15M	NO	1-15M	YES	1-15M	YES
1800 (6)	1-10M	NO	1-10M	NO	1-10M	NO	1-10M	NO	1-15M	NO	1-15M	NO	1-15M	NO	1-15M	YES	1-20M	YES
2400 (8)	1-10M	NO	1-10M	NO	1-15M	NO	1-15M	NO	1-15M	NO	1-20M	NO	2-15M	NO	2-15M	YES	2-15M	YES
3000 (10)	1-15M	NO	1-15M	NO	1-15M	NO	1-20M	NO	2-15M	NO	2-15M	NO	2-15M	NO	1-15M + 1-20M	YES	1-15M + 1-20M	YES
3600 (12)	1-15M	NO	1-20M	NO	1-20M	NO	2-15M	NO	2-15M	NO	2-20M	NO	2-20M	YES				
4200 (14)	1-20M	NO	2-15M	NO	2-15M	NO	2-15M	NO	1-15M + 1-20M	NO	1-10M + 2-20M	NO	1-15M + 2-20M	YES				
4800 (16)	2-15M	NO	2-15M	NO	2-15M	NO	1-15M + 1-20M	NO	1-10M + 2-20M	NO	3-20M	NO						
5400 (18)	2-15M	NO	2-15M	NO	1-15M + 1-20M	NO	2-20M	NO	3-20M	NO								
6000 (20)	2-15M	NO	1-15M + 1-20M	NO	1-10M + 2-20M	NO	1-15M + 2-20M	NO	1-15M + 3-20M	NO								

NOTES:

1. Stirrup spacing (s) is given in "inch" and "mm"
2. Do not install more than 4-20M bottom bar or equivalent combination of smaller bars.
3. Bottom reinforcement located 89mm (3.5") from bottom of lintel.
4. This table to be used in conjunction with the "Lintel Design Limitations" & "Lintel Drawing".
5. Beams with "NO Stirrups Required" do not require stirrups, except provide a minimum of three stirrups at each end of the lintel where  $S_{a,ICF} > 0.16$ .

# ICFMA

## INSULATING CONCRETE FORMS MANUFACTURERS ASSOCIATION



**Table L. 8. 12" Lintel Reinforcement with Concentrated Load**

Lintel Span, mm (ft)	Lintel - 12" Thick x 8" Deep (300mm Thick x 200mm Deep), s = 3" (75mm)																	
	Unfactored Point Load																	
	4 kN 800 lb		6 kN 1300 lb		8 kN 1700 lb		10 kN 2200 lb		12 kN 2600 lb		14 kN 3100 lb		16 kN 3500 lb		18 kN 4000 lb		20 kN 4400 lb	
	Bottom Reinf. Steel	Stirrups Required ?	Bottom Reinf. Steel	Stirrups Required ?	Bottom Reinf. Steel	Stirrups Required ?	Bottom Reinf. Steel	Stirrups Required ?	Bottom Reinf. Steel	Stirrups Required ?	Bottom Reinf. Steel	Stirrups Required ?	Bottom Reinf. Steel	Stirrups Required ?	Bottom Reinf. Steel	Stirrups Required ?	Bottom Reinf. Steel	Stirrups Required ?
900 (3)	1-10M	NO	1-10M	NO	1-15M	NO	1-15M	NO	1-15M	NO	1-15M	NO	1-15M	YES	1-15M	YES	1-20M	YES
1200 (4)	1-15M	NO	1-15M	NO	1-15M	NO	1-15M	NO	1-15M	NO	1-20M	NO	1-20M	YES	2-15M	YES	2-15M	YES
1500 (5)	1-15M	NO	1-15M	NO	1-20M	NO	1-20M	NO	2-15M	NO	2-15M	NO	1-15M + 1-20M	YES				
1800 (6)	1-15M	NO	1-20M	NO	2-15M	NO	2-15M	NO										
2400 (8)	2-15M	NO																
3000 (10)																		
3600 (12)																		
4200 (14)																		
4800 (16)																		
5400 (18)																		
6000 (20)																		

NOTES:

1. Stirrup spacing (s) is given in "inch" and "mm"
2. Do not install more than 1-15M + 1-20M bottom bar or equivalent combination of smaller bars.
3. Bottom reinforcement located 89mm (3.5") from bottom of lintel.
4. This table to be used in conjunction with the "Lintel Design Limitations" & "Lintel Drawing".
5. Beams with "NO Stirrups Required" do not require stirrups, except provide a minimum of three stirrups at each end of the lintel where  $S_{a,ICF} > 0.16$ .

Lintel Span, mm (ft)	Lintel - 12" Thick x 12" Deep (300mm Thick x 300mm Deep), s = 6" (150mm)																	
	Unfactored Point Load																	
	4 kN 800 lb		6.5 kN 1400 lb		9 kN 2000 lb		11.5 kN 2500 lb		14 kN 3100 lb		16.5 kN 3700 lb		19 kN 4200 lb		21.5 kN 4800 lb		24 kN 5300 lb	
	Bottom Reinf. Steel	Stirrups Required ?	Bottom Reinf. Steel	Stirrups Required ?	Bottom Reinf. Steel	Stirrups Required ?	Bottom Reinf. Steel	Stirrups Required ?	Bottom Reinf. Steel	Stirrups Required ?	Bottom Reinf. Steel	Stirrups Required ?	Bottom Reinf. Steel	Stirrups Required ?	Bottom Reinf. Steel	Stirrups Required ?	Bottom Reinf. Steel	Stirrups Required ?
900 (3)	1-10M	NO	1-10M	NO	1-10M	NO	1-10M	NO	1-15M	NO	1-15M	NO	1-15M	NO	1-15M	NO	1-15M	YES
1200 (4)	1-10M	NO	1-10M	NO	1-10M	NO	1-15M	NO	1-15M	NO	1-15M	NO	1-15M	NO	1-20M	NO	1-20M	YES
1500 (5)	1-10M	NO	1-15M	NO	1-15M	NO	1-15M	NO	1-20M	NO	1-20M	NO	1-20M	NO	1-20M	YES	2-15M	YES
1800 (6)	1-15M	NO	1-15M	NO	1-20M	NO	1-20M	NO	1-20M	NO	1-20M	NO	2-15M	NO	2-15M	YES	1-15M + 1-20M	YES
2400 (8)	1-20M	NO	1-20M	NO	1-20M	NO	2-15M	NO	1-15M + 1-20M	NO	2-20M	NO	1-10M + 2-20M	NO	1-15M + 2-20M	YES		
3000 (10)	1-20M	NO	2-15M	NO	1-15M + 1-20M	NO	2-20M	NO	1-15M + 2-20M	NO								
3600 (12)	2-15M	NO	2-20M	NO	1-15M + 2-20M	NO												
4200 (14)	2-20M	NO	3-20M	NO														
4800 (16)																		
5400 (18)																		
6000 (20)																		

NOTES:

1. Stirrup spacing (s) is given in "inch" and "mm"
2. Do not install more than 3-20M bottom bar or equivalent combination of smaller bars.
3. Bottom reinforcement located 89mm (3.5") from bottom of lintel.
4. This table to be used in conjunction with the "Lintel Design Limitations" & "Lintel Drawing".
5. Beams with "NO Stirrups Required" do not require stirrups, except provide a minimum of three stirrups at each end of the lintel where  $S_{a,ICF} > 0.16$ .

Lintel Span, mm (ft)	Lintel - 12" Thick x 16" Deep (300mm Thick x 400mm Deep), s = 8" (200mm)																	
	Unfactored Point Load																	
	4 kN 800 lb		7 kN 1500 lb		10 kN 2200 lb		13 kN 2900 lb		16 kN 3500 lb		19 kN 4200 lb		21 kN 4700 lb		24 kN 5300 lb		27 kN 6000 lb	
	Bottom Reinf. Steel	Stirrups Required ?	Bottom Reinf. Steel	Stirrups Required ?	Bottom Reinf. Steel	Stirrups Required ?	Bottom Reinf. Steel	Stirrups Required ?	Bottom Reinf. Steel	Stirrups Required ?	Bottom Reinf. Steel	Stirrups Required ?	Bottom Reinf. Steel	Stirrups Required ?	Bottom Reinf. Steel	Stirrups Required ?	Bottom Reinf. Steel	Stirrups Required ?
900 (3)	1-10M	NO	1-10M	NO	1-10M	NO	1-10M	NO	1-10M	NO	1-10M	NO	1-10M	NO	1-15M	NO	1-15M	NO
1200 (4)	1-10M	NO	1-10M	NO	1-10M	NO	1-10M	NO	1-15M	NO	1-15M	NO	1-15M	NO	1-15M	NO	1-15M	NO
1500 (5)	1-10M	NO	1-10M	NO	1-10M	NO	1-15M	NO	1-15M	NO	1-15M	NO	1-20M	NO	1-20M	NO	1-20M	YES
1800 (6)	1-10M	NO	1-15M	NO	1-15M	NO	1-15M	NO	1-20M	NO	1-20M	NO	1-20M	NO	2-15M	NO	2-15M	YES
2400 (8)	1-15M	NO	1-20M	NO	1-20M	NO	1-20M	NO	1-20M	NO	2-15M	NO	1-15M + 1-20M	NO	2-20M	NO	1-15M + 2-20M	YES
3000 (10)	1-20M	NO	1-20M	NO	2-15M	NO	2-15M	NO	1-15M + 1-20M	NO	2-20M	NO	1-15M + 2-20M	NO	1-10M + 3-20M	YES		
3600 (12)	1-20M	NO	2-15M	NO	1-15M + 1-20M	NO	2-20M	NO	1-10M + 2-20M	NO	1-10M + 3-20M	NO	4-20M	NO				
4200 (14)	2-15M	NO	2-20M	NO	1-10M + 2-20M	NO	1-15M + 2-20M	NO	1-10M + 3-20M	NO								
4800 (16)	2-20M	NO	1-10M + 2-20M	NO	1-10M + 3-20M	NO	4-20M	NO										
5400 (18)	1-10M + 2-20M	NO	1-10M + 3-20M	NO	4-20M	NO												
6000 (20)	3-20M	NO																

- NOTES:
1. Stirrup spacing (s) is given in "inch" and "mm"
  2. Do not install more than 4-20M bottom bar or equivalent combination of smaller bars.
  3. Bottom reinforcement located 89mm (3.5") from bottom of lintel.
  4. This table to be used in conjunction with the "Lintel Design Limitations" & "Lintel Drawing".
  5. Beams with "NO Stirrups Required" do not require stirrups, except provide a minimum of three stirrups at each end of the lintel where  $S_{a,ICF} > 0.16$ .

Lintel Span, mm (ft)	Lintel - 12" Thick x 24" Deep (300mm Thick x 600mm Deep), s = 12" (300mm)																	
	Unfactored Point Load																	
	4 kN 800 lb		8 kN 1700 lb		12 kN 2600 lb		16 kN 3500 lb		20 kN 4400 lb		24 kN 5300 lb		28 kN 6200 lb		32 kN 7100 lb		36 kN 8000 lb	
	Bottom Reinf. Steel	Stirrups Required ?	Bottom Reinf. Steel	Stirrups Required ?	Bottom Reinf. Steel	Stirrups Required ?	Bottom Reinf. Steel	Stirrups Required ?	Bottom Reinf. Steel	Stirrups Required ?	Bottom Reinf. Steel	Stirrups Required ?	Bottom Reinf. Steel	Stirrups Required ?	Bottom Reinf. Steel	Stirrups Required ?	Bottom Reinf. Steel	Stirrups Required ?
900 (3)	1-10M	NO	1-10M	NO	1-10M	NO	1-10M	NO	1-10M	NO	1-10M	NO	1-10M	NO	1-10M	NO	1-15M	NO
1200 (4)	1-10M	NO	1-10M	NO	1-10M	NO	1-10M	NO	1-10M	NO	1-10M	NO	1-15M	NO	1-15M	NO	1-15M	NO
1500 (5)	1-10M	NO	1-10M	NO	1-10M	NO	1-10M	NO	1-15M	NO	1-15M	NO	1-15M	NO	1-15M	NO	1-15M	NO
1800 (6)	1-10M	NO	1-10M	NO	1-10M	NO	1-15M	NO	1-15M	NO	1-15M	NO	1-15M	NO	1-20M	NO	1-20M	NO
2400 (8)	1-15M	NO	1-15M	NO	1-15M	NO	1-15M	NO	1-20M	NO	1-20M	NO	2-15M	NO	2-15M	NO	2-15M	YES
3000 (10)	1-15M	NO	1-20M	NO	1-20M	NO	2-15M	NO	2-15M	NO	2-15M	NO	1-15M + 1-20M	NO	2-20M	NO	1-10M + 2-20M	YES
3600 (12)	1-20M	NO	2-15M	NO	2-15M	NO	2-15M	NO	2-15M	NO	2-20M	NO	1-10M + 2-20M	NO	1-15M + 2-20M	NO		
4200 (14)	2-15M	NO	2-15M	NO	2-15M	NO	1-15M + 1-20M	NO	2-20M	NO	1-10M + 2-20M	NO	3-20M	NO				
4800 (16)	2-15M	NO	1-15M + 1-20M	NO	2-20M	NO	1-10M + 2-20M	NO	1-15M + 2-20M	NO	1-10M + 3-20M	NO	4-20M	NO				
5400 (18)	1-15M + 1-20M	NO	2-20M	NO	1-10M + 2-20M	NO	3-20M	NO	1-10M + 3-20M	NO	4-20M	NO						
6000 (20)	2-20M	NO	1-10M + 2-20M	NO	3-20M	NO	1-15M + 3-20M	NO										

- NOTES:
1. Stirrup spacing (s) is given in "inch" and "mm"
  2. Do not install more than 4-20M bottom bar or equivalent combination of smaller bars.
  3. Bottom reinforcement located 89mm (3.5") from bottom of lintel.
  4. This table to be used in conjunction with the "Lintel Design Limitations" & "Lintel Drawing".
  5. Beams with "NO Stirrups Required" do not require stirrups, except provide a minimum of three stirrups at each end of the lintel where  $S_{a,ICF} > 0.16$ .

Lintel Span, mm (ft)	Lintel - 12" Thick x 32" Deep (300mm Thick x 800mm Deep), s = 16" (400mm)																	
	Unfactored Point Load																	
	4 kN 800 lb		9 kN 2000 lb		14 kN 3100 lb		19 kN 4200 lb		24 kN 5300 lb		29 kN 6500 lb		34 kN 7600 lb		39 kN 8700 lb		44 kN 9800 lb	
	Bottom Reinf. Steel	Stirrups Required ?	Bottom Reinf. Steel	Stirrups Required ?	Bottom Reinf. Steel	Stirrups Required ?	Bottom Reinf. Steel	Stirrups Required ?	Bottom Reinf. Steel	Stirrups Required ?	Bottom Reinf. Steel	Stirrups Required ?	Bottom Reinf. Steel	Stirrups Required ?	Bottom Reinf. Steel	Stirrups Required ?	Bottom Reinf. Steel	Stirrups Required ?
900 (3)	1-10M	NO	1-10M	NO	1-10M	NO	1-10M	NO	1-10M	NO	1-10M	NO	1-10M	NO	1-10M	NO	1-10M	NO
1200 (4)	1-10M	NO	1-10M	NO	1-10M	NO	1-10M	NO	1-10M	NO	1-10M	NO	1-10M	NO	1-15M	NO	1-15M	NO
1500 (5)	1-10M	NO	1-10M	NO	1-10M	NO	1-10M	NO	1-10M	NO	1-15M	NO	1-15M	NO	1-15M	NO	1-15M	NO
1800 (6)	1-10M	NO	1-10M	NO	1-10M	NO	1-10M	NO	1-15M	NO	1-15M	NO	1-15M	NO	1-15M	NO	1-20M	NO
2400 (8)	1-10M	NO	1-15M	NO	1-15M	NO	1-15M	NO	1-15M	NO	1-20M	NO	2-15M	NO	2-15M	NO	1-15M + 1-20M	NO
3000 (10)	1-15M	NO	1-15M	NO	1-15M	NO	1-20M	NO	2-15M	NO	2-15M	NO	1-15M + 1-20M	NO	1-15M + 1-20M	NO	2-20M	YES
3600 (12)	1-15M	NO	1-20M	NO	1-20M	NO	2-15M	NO	1-15M + 1-20M	NO	1-15M + 1-20M	NO	2-20M	NO	1-15M + 2-20M	NO		
4200 (14)	1-20M	NO	2-15M	NO	2-15M	NO	1-15M + 1-20M	NO	1-15M + 1-20M	NO	1-10M + 2-20M	NO	1-15M + 2-20M	NO				
4800 (16)	2-15M	NO	1-15M + 1-20M	NO	1-15M + 1-20M	NO	1-15M + 1-20M	NO	1-10M + 2-20M	NO	3-20M	NO						
5400 (18)	1-15M + 1-20M	NO	1-15M + 1-20M	NO	1-15M + 1-20M	NO	3-20M	NO	3-20M	NO	1-15M + 3-20M	NO						
6000 (20)	1-15M + 1-20M	NO	2-20M	NO	1-10M + 2-20M	NO	1-15M + 2-20M	NO	1-15M + 3-20M	NO								

NOTES:

1. Stirrup spacing (s) is given in "inch" and "mm"
2. Do not install more than 4-20M bottom bar or equivalent combination of smaller bars.
3. Bottom reinforcement located 89mm (3.5") from bottom of lintel.
4. This table to be used in conjunction with the "Lintel Design Limitations" & "Lintel Drawing".
5. Beams with "NO Stirrups Required" do not require stirrups, except provide a minimum of three stirrups at each end of the lintel where  $S_{a,ICF} > 0.16$ .

# ICFMA

## INSULATING CONCRETE FORMS MANUFACTURERS ASSOCIATION

## Concentrated Point Load Table

**Table C. 1. Maximum Un-Factored Point Load on a Solid Wall Without Opening**

Solid Wall Length Under a Point Load, m(ft)	0.91 (3)	1.22 (4)	1.52 (5)
Maximum Unfactored Point Load, kN	225	300	375

**NOTES:**

1. Provide beam pockets, as necessary.
2. In addition to the wall reinforcing required in the following tables, two additional 15M vertical bars shall be installed directly below the point load.
3. Maximum un-factored point loads given in Table C. 1 are only the wall capacity. It is the responsibility of the roof and floor designer to ensure adequate bearing for all framing members is provided on the concrete walls.

# ICFMA

## INSULATING CONCRETE FORMS MANUFACTURERS ASSOCIATION

## Stair Opening Tables

**Table A. 12. Above Grade Wall Distributed Horizontal Reinforcement at Stair Openings**

Seismic Zone Classification:  $S_{a,ICF} \leq 0.79$

Hourly wind Pressure:  $q_{1/50} \leq 1.05$

Wall Thickness mm(in)	Max Length of Stair Opening (Unsupported Length of Wall) m(ft)	Block Height mm(in)	Horizontal Reinforcement Size and Spacing, mm (in)		
			Seismic Zone Classification, $S_{a,ICF}$		
			$\leq 0.16$	$\leq 0.31$	$\leq 0.79$
			Hourly Winds Pressure, $q_{1/50}$ (kPa)		
			$\leq 0.5$	$\leq 0.75$	$\leq 1.05$
150 (6)	4.5 (15)	300 (12) & 450 (18)	15M @ 450 (18)	15M @ 450 (18)	15M @ 300 (12)
		400 (16)	15M @ 400 (16)	15M @ 400 (16)	15M @ 300 (12)
200 (8)	5.1 (17)	300 (12) & 450 (18)	15M @ 450 (18)	15M @ 450 (18)	15M @ 300 (12)
		400 (16)	15M @ 400 (16)	15M @ 400 (16)	15M @ 300 (12)
250 (10)	5.1 (17)	300 (12) & 450 (18)	10M @ 450 (18)	15M @ 450 (18)	15M @ 300 (12)
		400 (16)	10M @ 400 (16)	15M @ 400 (16)	15M @ 300 (12)
300 (12)	5.7 (19)	300 (12) & 450 (18)	10M @ 450 (18) (2 layers)	10M @ 450 (18) (2 layers)	15M @ 300 (12) (2 layers)
		400 (16)	10M @ 400 (16) (2 layers)	10M @ 400 (16) (2 layers)	15M @ 300 (12) (2 layers)

**NOTES:**

1. This table to be used in conjunction with the "Design Parameters".
2. This table applies to all height of above grade walls where there is no lateral support at the floor level because of stair opening.
3. The laterally unsupported length at the top of the wall is the dimension of the stair opening parallel to the wall.
4. Single bars are to be staggered and the vertical bars are to be placed between these staggered bars, as per Detail A.1 and A.2.
5. Increase the horizontal reinforcement as per this table and extend beyond the stair opening a minimum of 900mm (3'-0"), bend bars, if necessary, at wall corners.
6. Provide a minimum of 1.22m (4'-0") length of laterally supported wall on each side of the opening. The 1.22m (4'-0") length may be a perpendicular wall on the same side as the stair opening. Bend horizontal bars around the corner to provide the minimum required 900mm (3'-0") extension.
7. Increase the vertical reinforcement on each side of the stair opening per the "Design Limitation" noted in section 5.5.5.
8. Place the reinforcing for 6", 8" and 10" thick wall in accordance with Detail A.1.
9. Provide two layers of indicated horizontal reinforcing for 300mm (12") walls. Place each layer as shown in Detail A.2.
10. Alternating horizontal bar spacing of 12" o.c. and 24" o.c. may be used to achieve an average spacing of 18" o.c. where 18" o.c. spacing is specified for horizontal bars.
11. Provide 3 horizontal bars in every two rows of 18" high block to achieve an average spacing of 12" o.c. where 12" spacing o.c. is specified for horizontal bars.
12. Provide 4 horizontal bars in every three rows of 16" high block to achieve an average spacing of 12" o.c. where 12" spacing o.c. is specified for horizontal bars.

INSULATING CONCRETE FORMS  
MANUFACTURERS ASSOCIATION

**Table B. 5. Below Grade Wall Distributed Horizontal Reinforcement at Stair Opening for Seismic Zone Classification  $S_a(0.2) \leq 0.7$ , Hourly Wind Pressure ,  $q_{1/50} \leq 1.05$  kPa, and Backfill**

Seismic Zone Classification:  $S_{a,ICF} \leq 0.31$

Hourly wind Pressure:  $q_{1/50} \leq 1.05$

Backfill Equivalent Fluid Density: 480 kg/m<sup>3</sup> (30pcf)

Wall Thickness mm(in)	Block Height mm(in)	Horizontal Reinforcement Size and Spacing, mm (in)			
		Seismic Zone Classification, $S_{a,ICF} \leq 0.11$			
		Max Length of Stair Opening (Unsupported Length of Wall), m(ft)			
		2.44 (8)	3.05 (10)	3.66 (12)	4.27 (14)
150 (6)	300 (12) & 450 (18)	15M @ 450 (18)	2-15M @ 450 (18)		
	400 (16)	15M @ 400 (16)	2-15M @ 400 (16)		
200 (8)	300 (12) & 450 (18)	15M @ 450 (18)	2-15M @ 450 (18)	2-15M @ 450 (18)	2-15M @ 300 (12)
	400 (16)	15M @ 400 (16)	2-15M @ 400 (16)	2-15M @ 400 (16)	2-15M @ 300 (12)
250 (10)	300 (12) & 450 (18)	15M @ 450 (18)	15M @ 450 (18)	2-15M @ 450 (18)	2-15M @ 450 (18)
	400 (16)	15M @ 400 (16)	15M @ 400 (16)	2-15M @ 400 (16)	2-15M @ 400 (16)
300 (12)	300 (12) & 450 (18)	15M @ 450 (18)	15M @ 450 (18)	15M @ 450 (18)	2-15M @ 450 (18)
	400 (16)	15M @ 400 (16)	15M @ 400 (16)	15M @ 400 (16)	2-15M @ 400 (16)
<b>Seismic Zone Classification, <math>S_{a,ICF} \leq 0.31</math></b>					
150 (6)	300 (12) & 450 (18)				
	400 (16)				
200 (8)	300 (12) & 450 (18)	2-15M @ 450 (18)			
	400 (16)	2-15M @ 400 (16)			
250 (10)	300 (12) & 450 (18)	2-15M @ 450 (18)	2-15M @ 450 (18)		
	400 (16)	2-15M @ 400 (16)	2-15M @ 400 (16)		
300 (12)	300 (12) & 450 (18)	15M @ 450 (18)	2-15M @ 450 (18)	2-15M @ 300 (12)	
	400 (16)	15M @ 400 (16)	2-15M @ 400 (16)	2-15M @ 300 (12)	

**NOTES:**

- This table to be used in conjunction with the "Design Parameters".
- This table applies to all height of below grade walls where there is no lateral support at the floor level because of stair opening.
- The laterally unsupported length at the top of the wall is the dimension of the stair opening parallel to the wall.
- The below grade wall maybe backfilled up to 6" below the top of the wall.
- Single bars are to be staggered between first two slots of ICF web on inside face of wall. The vertical bars are to be placed between these staggered bars, as per Detail B.1.
- Where two bars are specified, they are to be placed as a single bundled bar staggered between the first two slots of the ICF web on the inside face of the wall. The vertical bars are to be placed between these staggered bars, as per Detail B.1.
- Increase the horizontal reinforcement as per this table and extend beyond the stair opening a minimum of 900mm (3'-0"), bend bars, if necessary, at wall corners.
- Provide a minimum of 1.22m (4'-0") length of laterally supported wall on each side of the opening. The 1.22m (4'-0") length may be a perpendicular wall on the same side as the stair opening. Bend horizontal bars around the corner to provide the minimum required 900mm (3'-0") extension.
- Increase the vertical reinforcement on each side of the stair opening per the "Design Limitation" noted in section 5.5.5.
- Reinforce the foundation wall at the stair opening as per the below grade wall reinforcement tables and this table for a minimum of 1.22m (4'-0") beyond each end of the stair opening for foundation wall that would not otherwise require reinforcing.
- Basement walls with stair opening at locations with Seismic Zone Classification  $S_{a,ICF} > 0.31$  or Backfill Equivalent Fluid Density  $> 480$  kg/m<sup>3</sup> (30pcf) shall be designed by a professional engineer.
- Alternating horizontal bar spacing of 12" o.c. and 24" o.c. may be used to achieve an average spacing of 18" o.c. where 18" o.c. spacing is specified for horizontal bars.
- Provide 3 horizontal bars in every two rows of 18" high block to achieve an average spacing of 12" o.c. where 12" spacing o.c. is specified for horizontal bars.
- Provide 4 horizontal bars in every three rows of 16" high block to achieve an average spacing of 12" o.c. where 12" spacing o.c. is specified for horizontal bars.

**Table A. 13. Bar Spacing Required at Each Side of the Stair Opening**

$S_{Table}$ , mm (in)	Laterally Unsupported Length of the Wall (Stair Opening Length), m (ft)						
	5.7 (19)	5.1 (17)	4.5 (15)	3.9 (13)	2.7 (9)	2.1 (7)	1.5 (5)
	$S_{REDUCED}$						
1200 (48)	350 (14)	375 (15)	400 (16)	450 (18)	550 (22)	625 (25)	725 (29)
1050 (42)	300 (12)	325 (13)	350 (14)	400 (16)	475 (19)	550 (22)	625 (25)
1000 (40)	275 (11)	300 (12)	325 (13)	375 (15)	450 (18)	525 (21)	600 (24)
900 (36)	250 (10)	275 (11)	300 (12)	325 (13)	400 (16)	475 (19)	550 (22)
800 (32)	225 (9)	250 (10)	275 (11)	300 (12)	375 (15)	425 (17)	475 (19)
750 (30)	200 (8)	225 (9)	250 (10)	275 (11)	350 (14)	400 (16)	450 (18)
600 (24)	175 (7)	175 (7)	200 (8)	225 (9)	275 (11)	300 (12)	350 (14)
450 (18)			150 (6)	150 (6)	200 (8)	225 (9)	275 (11)
400 (16)				150 (6)	175 (7)	200 (8)	225 (9)
300 (12)						150 (6)	175 (7)

**Notes:**

1.  $S_{REDUCED}$  = the bar spacing (mm/in) required at the sides of the stair opening.
2.  $S_{TABLES}$  = the required bar spacing (mm/in) for a laterally supported wall as determined from above grade and below grade walls tables.
3. If the spacing of the additional vertical reinforcing required on each side of openings, described in the equation given in part 5.5., is less than 150mm (6"), a local design professional shall be retained to prepare the design in accordance with applicable standards.

ICFMA

INSULATING CONCRETE FORMS  
MANUFACTURERS ASSOCIATION

# Laterally Supported Foundation Wall Detail and Table

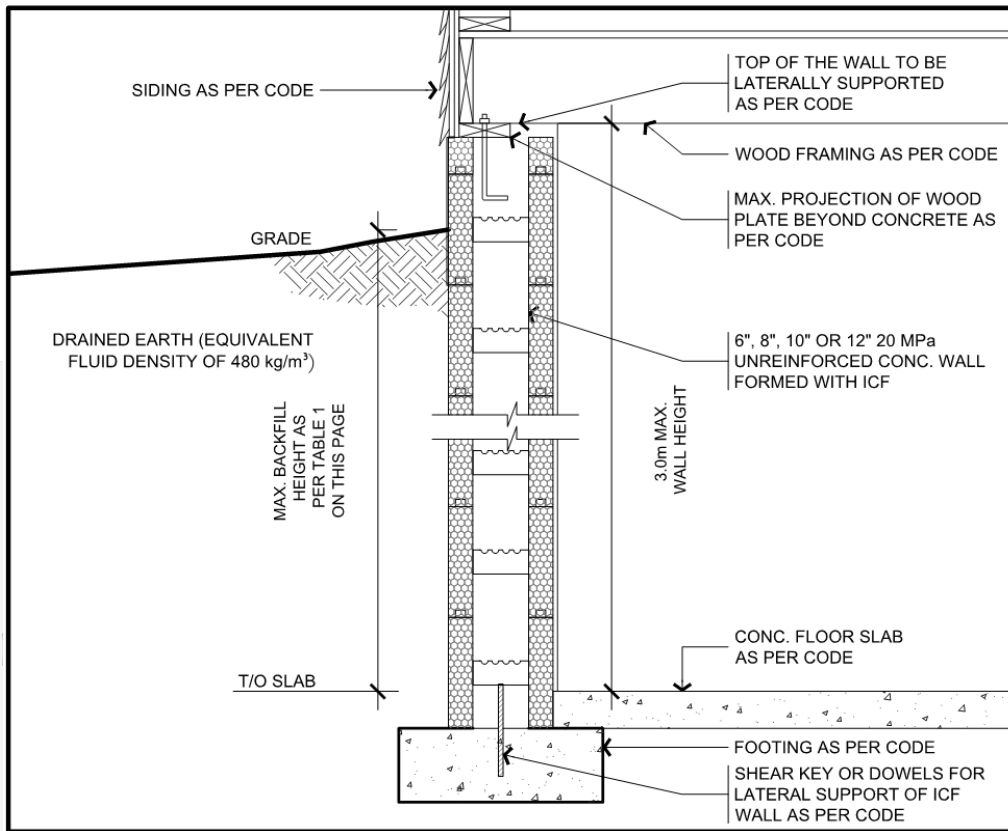

**Detail B. 2. Laterally Supported Foundation Wall**

**Table B. 6. Maximum Height of Finish Ground Above Basement Floor**

Minimum Wall Thickness	Height of Foundation Wall		
	≤ 2.5m (8'-2")	>2.5m & ≤2.75m (9'-0")	>2.75m & ≤3.0m (9'-10")
6"	1.8m (5'-10")	1.6m (5'-3")	1.6m (5'-3")
8"	2.3m (7'-6")	2.3m (7'-6")	2.2m (7'-2")
10"	2.3m (7'-6")	2.6m (8'-6")	2.85m (9'-4")
12"	2.3m (7'-6")	2.6m (8'-6")	2.85m (9'-4")

**Notes:**

1. This section references Part 9 of the 2020 National Building Code of Canada.
2. This detail applies to one- and two-story buildings conforming to part 9 of the 2020 National Building Code of Canada.
3. This table is a copy of NBCC 2020 T.9.15.4.2-A.
4. This table to be used in conjunction with section 5.6. of this design manual.



# Laterally Unsupported Foundation Wall Detail and Table

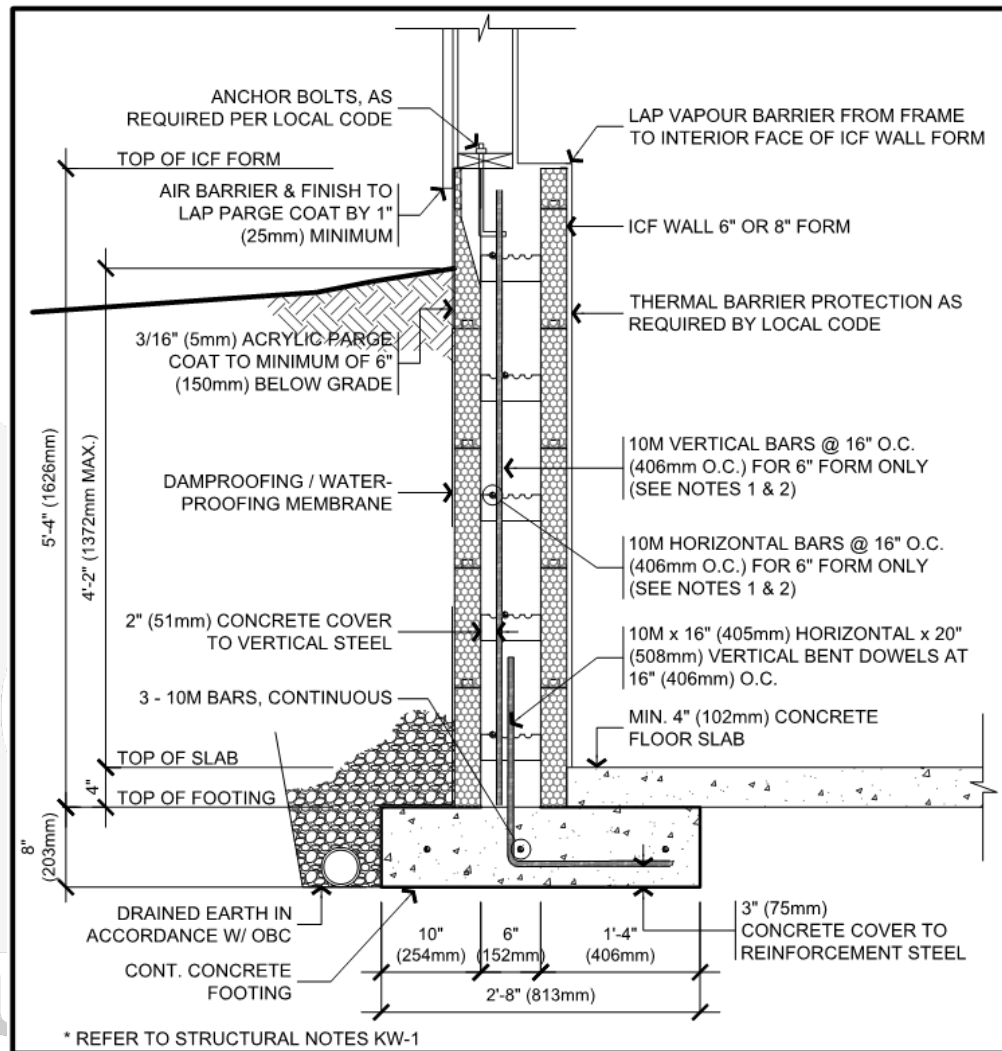

Notes:

1. This detail applies to one- and two-story buildings conforming to part 9 of the 2020 National Building Code of Canada.
2. Wall reinforcing not required when using 8" forms or thicker (As per table 9.15.4.2.-A of the 2020 National Building Code of Canada).
3. Wall reinforcing not required for 6" forms where the backfill height above basement floor does not exceed 2'-7" (As per table 9.15.4.2.-A of the 2020 National Building Code of Canada).
4. Footing reinforcement and dowels are required for all cases.
5. Refer to section 5.7., for additional information.

### Detail B. 3. Laterally Unsupported Foundation Wall (Knee Wall)

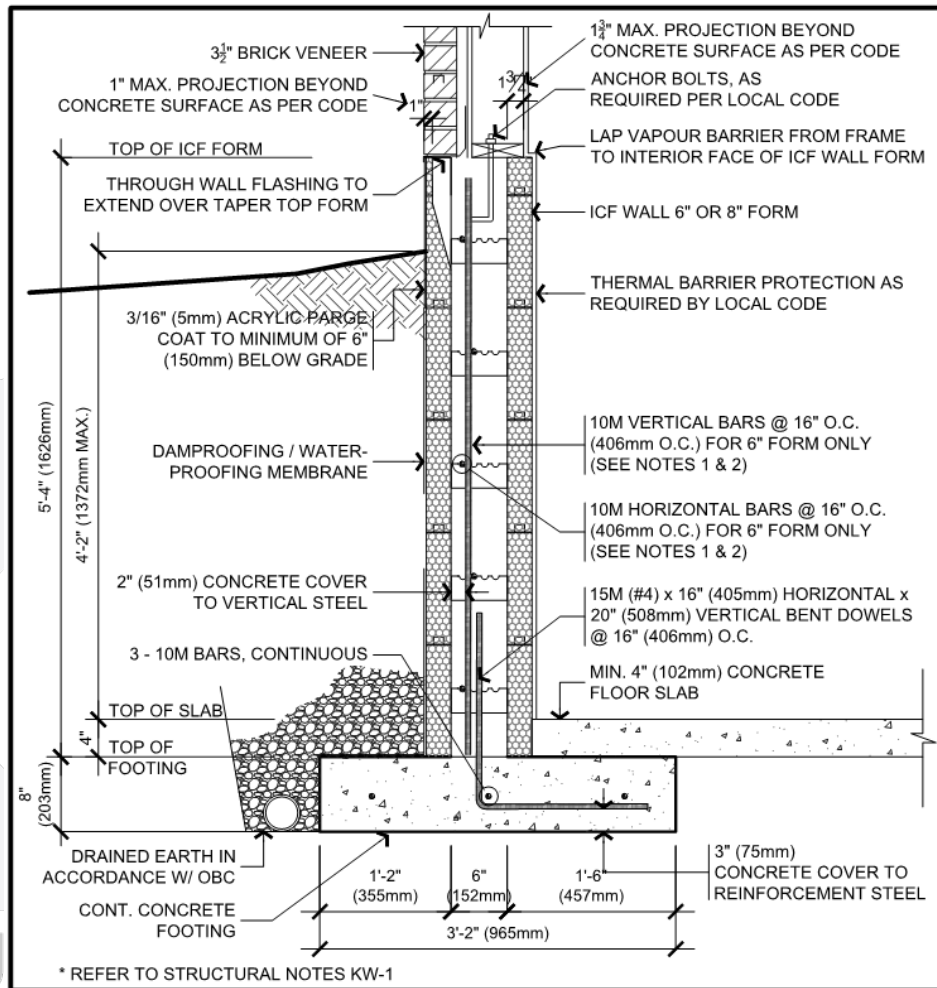

Notes:

1. This detail applies to one- and two-story buildings conforming to part 9 of the 2020 National Building Code of Canada.
2. Wall reinforcing not required when using 8" forms (As per table 9.15.4.2.-A of the 2020 National Building Code of Canada).
3. Wall reinforcing not required for 6" forms where the backfill height above basement floor does not exceed 2'-7" (As per table 9.15.4.2.-A of the 2020 National Building Code of Canada).
4. Footing reinforcement and dowels are required for all cases.
5. Refer to section 5.7., for additional information.

**Detail B. 4. Laterally Unsupported Foundation Wall (Knee Wall) with Brick Veneer**

# Ledger Connection Detail and Table

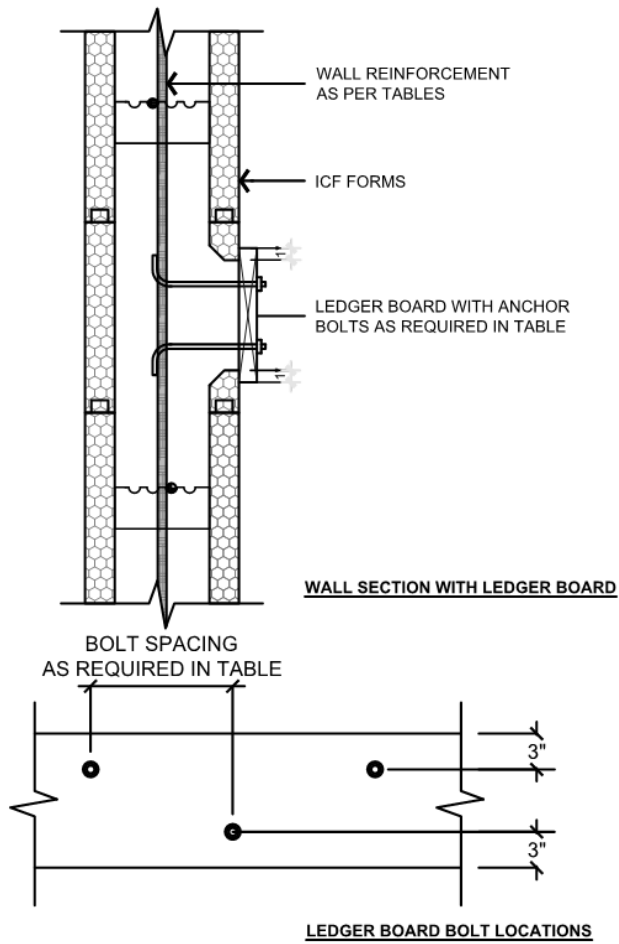

**Detail C. 1. Wood Ledger Connection**

**Table C. 2. Floor Ledger Anchor Bolts Size and Spacing**

Anchor Bolt Diameter	Minimum Spacing of Staggered Anchors, in					
	Tie Spacing	Floor span, ft (m)				
		8' (2.44m)	12' (3.66m)	16' (4.88m)	20' (6.1m)	24' (7.32m)
1/2"	6"	18"	12"	12"	6"	6"
	8"	16"	16"	8"	8"	8"
5/8"	6"	24"	18"	12"	12"	6"
	8"	24"	16"	16"	8"	8"

**Notes:**

1. Anchor bolts to be installed at the indicated spacing and staggered as shown.
2. Design assumes floor ledger supports vertical floor load only. Design of floor diaphragm by others.
3. Design loads: 40psf (1.9 kPa) floor live load, 15psf (0.7 kPa) floor dead load.
4. Anchor bolts shall conform to the requirements of ASTM standard A307.
5. Anchor bolt connection to be installed at Dry Service Condition.

# Brick Ledge Detail and Table

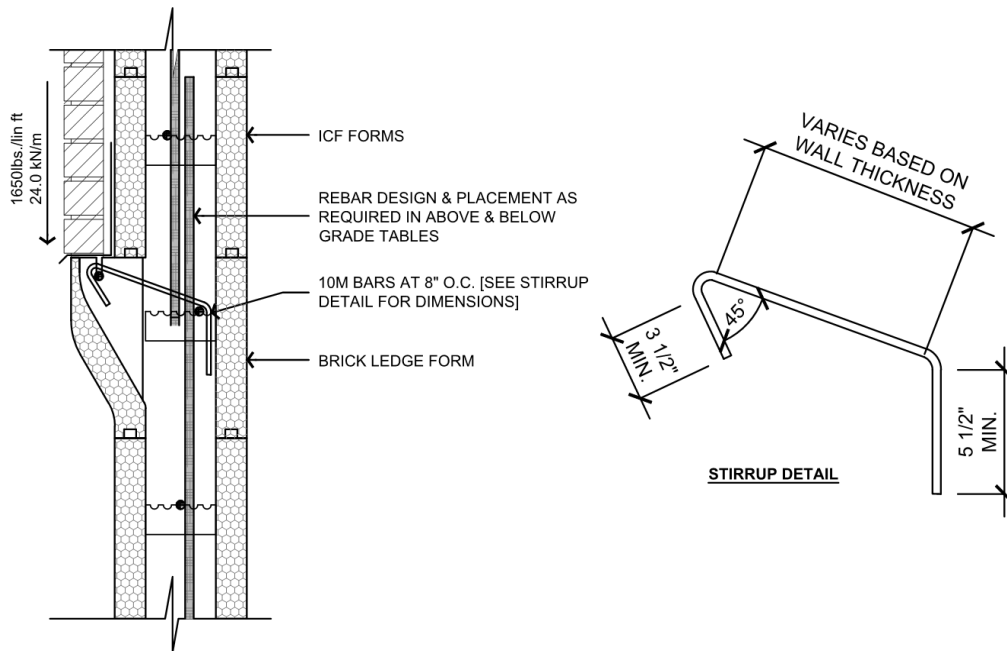

**Detail C. 2. Brick Ledge Connection**

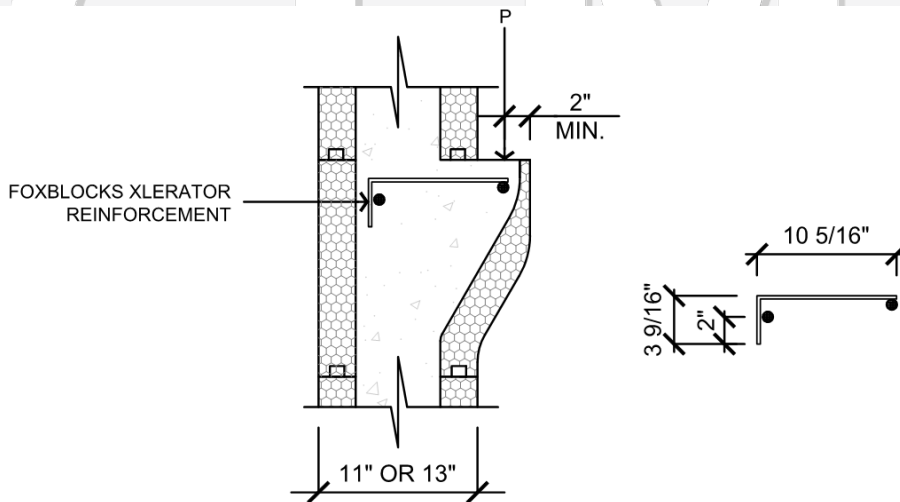

NOTE: xLERATOR REINFORCEMENT TO BE D4 DEFORMED WELDED WIRE WITH A YIELD STRENGTH OF 483MPa (70ksi) IN ACCORDANCE WITH ASTM A1064 REQUIREMENTS.

**Detail C. 3. FOXBLOCKS xLerator Ledge Reinforcement**

**Table C. 3. Brick Ledge Load Capacity**

Application	Capacity
Brick - max 4" thick - max 20kN/m <sup>3</sup>	9.6m (31'-6") high
Wood Floor Joists - 0.7kPa (15psf) Dead Load - 1.9kPa (40psf) Live Load	6.4m (21') Tributary floor width
Other - maximum factored load	24kN/m (1650 plf)

**Notes:**

1. Concrete Ledge reinforcement is to support floor framing and masonry veneer in conformance with the "Design Limitations".
2. The concrete ledge is to support uniformly distributed loads only. It is not to support concentrated load.
3. The above grade and below grade wall reinforcing tables include the effects of using the ledge to support floor framing.
4. The below grade wall reinforcing tables include the effects of using the ledge to support masonry veneer.
5. The maximum brick height given does not account for windows. To include the effect of windows, it is necessary to calculate an effective brick height.
6. The ledge reinforcement is 10M hooked rebar as shown in Detail C. 2. It is to be placed 6" or 8" on center matching the tie spacing of ICF blocks.
7. Provide the required concrete cover for the vertical leg of the ledge reinforcement.

ICFMA

INSULATING CONCRETE FORMS  
MANUFACTURERS ASSOCIATION

# Footing Details and Tables

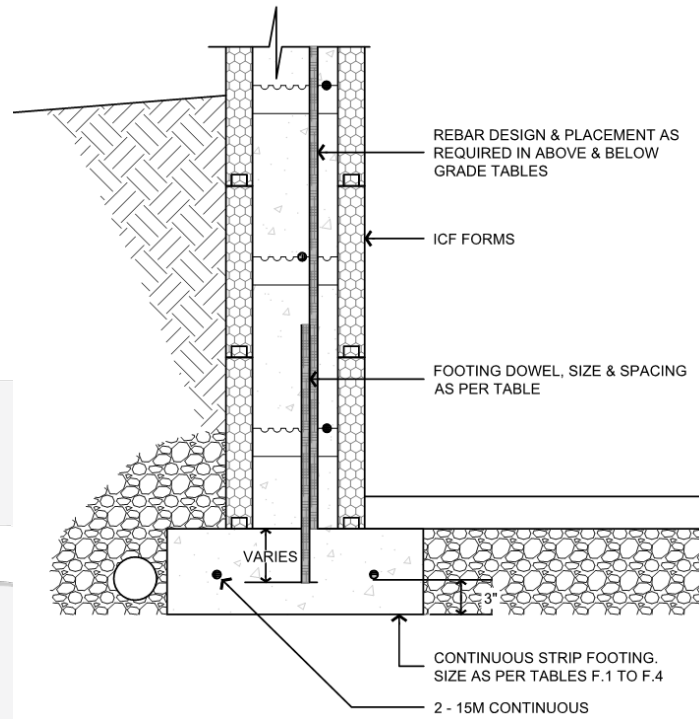

**Detail F. 1. Footing Dowel**

**Table F. 1. Footing Dowels Size and Spacing**

Rebar Diameter	Maximum Spacing of Vertical Footing Dowels, in				
	Backfill Height, ft (m)				
	4' (1.22m)	6' (1.83m)	8' (2.44m)	10' (3.05m)	12' (3.66)
Seismic Zone Classification: $S_{a,ICF} \leq 0.16$					
10M	48"	48"	24"	8"	8"
15M	48"	48"	36"	16"	8"
Seismic Zone Classification: $S_{a,ICF} \leq 0.31$					
10M	24"	24"	16"	8"	8"
15M	24"	24"	24"	16"	8"
Seismic Zone Classification: $S_{a,ICF} \leq 0.79$					
10M	24"	16"			
15M	24"	16"	8"		

**Notes:**

1. Footing Dowels to be installed as per Details F.1.
2. Provide 18" long straight dowels for  $S_{a,ICF} \leq 0.16$  embedded 6" into the footing.
3. Provide 30"V x 8"H bent dowels for  $S_{a,ICF} > 0.16$  embedded 8" into the footing.
4. Provide 30"V x 8"H bent dowels embedded 8" into the footing at shear walls locations, matching the size and spacing of vertical bars of the shear walls.

**Table F. 2. Minimum Exterior Strip Footing Sizes Not Supporting Roof Loads**

ICF Wall Thickness, in (mm)	Minimum Footing Width x Thickness, in x in			
	Allowable Soil Bearing Pressure, psf (kPa)			
	3000 (144)	2500 (120)	2000 (96)	1500 (72)
<b>Two Storey - ICF Basement Walls, Wood Main Floor Walls, and Wood Second Floor Walls</b>				
6 (150)	16" x 6"	16" x 6"	16" x 6"	20" x 6"
8 (200)	18" x 6"	18" x 6"	18" x 6"	22" x 6"
10 (250)	20" x 6"	20" x 6"	20" x 6"	24" x 6"
12 (300)	22" x 6"	22" x 6"	22" x 6"	26" x 8"
<b>Two Storey - ICF Basement Walls, ICF Main Floor Walls, and Wood Second Floor Walls</b>				
6 (150)	16" x 6"	18" x 6"	22" x 8"	28" x 8"
8 (200)	18" x 6"	20" x 6"	26" x 8"	34" x 10"
10 (250)	20" x 6"	24" x 8"	30" x 10"	40" x 10"
12 (300)	22" x 8"	26" x 8"	32" x 10"	42" x 12"
<b>Two Storey - ICF Basement Walls, ICF Main Floor Walls, and ICF Second Floor Walls</b>				
6 (150)	18" x 8"	20" x 8"	26" x 10"	34" x 10"
8 (200)	22" x 8"	26" x 8"	32" x 10"	42" x 12"
10 (250)	26" x 8"	30" x 10"	38" x 12"	50" x 14"
12 (300)	26" x 8"	32" x 10"	40" x 12"	52" x 14"
<b>One Storey - ICF Basement Walls, and Wood Main Floor Walls</b>				
6 (150)	16" x 6"	16" x 6"	16" x 6"	16" x 6"
8 (200)	18" x 6"	18" x 6"	18" x 6"	18" x 6"
10 (250)	20" x 6"	20" x 6"	20" x 6"	20" x 6"
12 (300)	22" x 6"	22" x 6"	22" x 6"	22" x 6"
<b>One Storey - ICF Basement Walls, and ICF Main Floor Walls</b>				
6 (150)	16" x 6"	16" x 6"	18" x 6"	24" x 8"
8 (200)	18" x 6"	18" x 6"	22" x 8"	28" x 8"
10 (250)	20" x 6"	20" x 6"	26" x 8"	34" x 10"
12 (300)	22" x 8"	22" x 8"	28" x 8"	36" x 10"

Notes:

1. All footings are to be reinforced with 2-15M continuous bars, as per drawing F.1.
2. Refer to the Canadian Design Limitations for maximum floor and roof spans and loads.
3. This table does not include masonry veneer. Increase the footing width by 2" and the thickness by 1" for:
  - b. Every 12'-0" of masonry veneer for 3000 psf soil bearing capacity.
  - c. Every 10'-0" of masonry veneer for 2500psf soil bearing capacity.
  - d. Every 8'-0" of masonry veneer for 2000psf soil bearing capacity.
  - e. Every 6'-0" of masonry veneer for 1500psf soil bearing capacity.
4. The footing size for locations with  $S_{a,ICF} > 0.16$  to be the larger of 30" wide by 12" deep or the size shown in the table.

**Table F. 3. Minimum Exterior Strip Footing Sizes Supporting Roof Snow Loads  $\leq 2\text{kPa}$**

ICF Wall Thickness, in (mm)	Minimum Footing Width x Thickness, in x in			
	Allowable Soil Bearing Pressure, psf (kPa)			
	3000 (144)	2500 (120)	2000 (96)	1500 (72)
<b>Two Storey - ICF Basement Walls, Wood Main Floor Walls, and Wood Second Floor Walls</b>				
6 (150)	16" x 6"	18" x 6"	22" x 8"	28" x 8"
8 (200)	18" x 6"	20" x 6"	24" x 8"	32" x 10"
10 (250)	20" x 6"	20" x 6"	26" x 8"	34" x 10"
12 (300)	22" x 8"	22" x 8"	28" x 8"	36" x 10"
<b>Two Storey - ICF Basement Walls, ICF Main Floor Walls, and Wood Second Floor Walls</b>				
6 (150)	20" x 8"	24" x 8"	28" x 10"	38" x 12"
8 (200)	22" x 8"	26" x 10"	32" x 10"	44" x 12"
10 (250)	24" x 8"	30" x 10"	36" x 10"	48" x 14"
12 (300)	26" x 8"	32" x 10"	38" x 12"	52" x 14"
<b>Two Storey - ICF Basement Walls, ICF Main Floor Walls, and ICF Second Floor Walls</b>				
6 (150)	22" x 8"	26" x 10"	32" x 10"	44" x 12"
8 (200)	26" x 10"	30" x 10"	38" x 12"	50" x 14"
10 (250)	30" x 10"	36" x 12"	44" x 14"	58" x 16"
12 (300)	30" x 10"	36" x 12"	46" x 14"	60" x 16"
<b>One Storey - ICF Basement Walls, and Wood Main Floor Walls</b>				
6 (150)	16" x 6"	16" x 6"	18" x 6"	24" x 8"
8 (200)	18" x 6"	18" x 6"	20" x 6"	26" x 8"
10 (250)	20" x 6"	20" x 6"	22" x 6"	28" x 8"
12 (300)	22" x 6"	22" x 6"	22" x 6"	30" x 8"
<b>One Storey - ICF Basement Walls, and ICF Main Floor Walls</b>				
6 (150)	16" x 6"	20" x 8"	24" x 8"	32" x 10"
8 (200)	20" x 8"	24" x 8"	28" x 10"	38" x 10"
10 (250)	22" x 8"	26" x 8"	32" x 10"	44" x 12"
12 (300)	24" x 8"	28" x 10"	34" x 10"	46" x 12"

Notes:

- All footings are to be reinforced with 2-15M continuous bars, as per drawing F.1.
- Refer to the Canadian Design Limitations for maximum floor and roof spans and loads.
- This table does not include masonry veneer. Increase the footing width by 2" and the thickness by 1" for:
  - Every 12'-0" of masonry veneer for 3000 psf soil bearing capacity.
  - Every 10'-0" of masonry veneer for 2500psf soil bearing capacity.
  - Every 8'-0" of masonry veneer for 2000psf soil bearing capacity.
  - Every 6'-0" of masonry veneer for 1500psf soil bearing capacity.
- The footing size for locations with  $S_{a,ICF} > 0.16$  to be the larger of 30" wide by 12" deep or the size shown in the table.



**Table F. 4. Minimum Exterior Strip Footing Sizes Supporting Roof Snow Loads  $\leq 4\text{kPa}$**

ICF Wall Thickness, in (mm)	Minimum Footing Width x Thickness, in x in			
	Allowable Soil Bearing Pressure, psf (kPa)			
	3000 (144)	2500 (120)	2000 (96)	1500 (72)
<b>Two Storey - ICF Basement Walls, Wood Main Floor Walls, and Wood Second Floor Walls</b>				
6 (150)	18" x 8"	22" x 8"	26" x 10"	36" x 10"
8 (200)	20" x 8"	24" x 8"	28" x 10"	38" x 10"
10 (250)	20" x 6"	24" x 8"	30" x 10"	40" x 10"
12 (300)	22" x 8"	26" x 8"	32" x 10"	42" x 12"
<b>Two Storey - ICF Basement Walls, ICF Main Floor Walls, and Wood Second Floor Walls</b>				
6 (150)	22" x 8"	28" x 10"	34" x 12"	44" x 14"
8 (200)	26" x 10"	30" x 10"	38" x 12"	50" x 14"
10 (250)	28" x 10"	34" x 12"	42" x 12"	56" x 16"
12 (300)	30" x 10"	36" x 12"	44" x 14"	58" x 16"
<b>Two Storey - ICF Basement Walls, ICF Main Floor Walls, and ICF Second Floor Walls</b>				
6 (150)	26" x 10"	30" x 12"	38" x 12"	50" x 14"
8 (200)	30" x 12"	34" x 12"	44" x 14"	58" x 16"
10 (250)	34" x 12"	40" x 14"	50" x 16"	66" x 18"
12 (300)	34" x 12"	40" x 14"	50" x 16"	68" x 18"
<b>One Storey - ICF Basement Walls, and Wood Main Floor Walls</b>				
6 (150)	16" x 6"	18" x 6"	22" x 8"	30" x 10"
8 (200)	18" x 6"	20" x 6"	24" x 8"	32" x 10"
10 (250)	20" x 6"	22" x 6"	26" x 8"	34" x 10"
12 (300)	22" x 8"	22" x 8"	28" x 8"	38" x 10"
<b>One Storey - ICF Basement Walls, and ICF Main Floor Walls</b>				
6 (150)	20" x 8"	24" x 8"	30" x 10"	38" x 12"
8 (200)	22" x 8"	28" x 10"	34" x 10"	44" x 12"
10 (250)	26" x 8"	30" x 10"	38" x 12"	50" x 14"
12 (300)	26" x 8"	32" x 10"	40" x 12"	52" x 14"

Notes:

- All footings are to be reinforced with 2-15M continuous bars, as per drawing F.1.
- Refer to the Canadian Design Limitations for maximum floor and roof spans and loads.
- This table does not include masonry veneer. Increase the footing width by 2" and the thickness by 1" for:
  - Every 12'-0" of masonry veneer for 3000 psf soil bearing capacity.
  - Every 10'-0" of masonry veneer for 2500psf soil bearing capacity.
  - Every 8'-0" of masonry veneer for 2000psf soil bearing capacity.
  - Every 6'-0" of masonry veneer for 1500psf soil bearing capacity.
- The footing size for locations with  $S_{a,ICF} > 0.16$  to be the larger of 30" wide by 12" deep or the size shown in the table.

# Appendix A. Equivalent Spectral Response Acceleration for ICF Walls, $S_{a,ICF}^*$

Province and Location	$S_{a,ICF}$
<b>British Columbia</b>	
100 Mile House	0.123
Abbotsford	0.518
Agassiz	0.374
Alberni	---
Ashcroft	0.172
Bamfield	---
Beaton River	0.108
Bella Bella	0.257
Bella Coola	0.182
Burns Lake	0.092
Cache Creek	0.168
Campbell River	0.549
Carmi	0.129
Castlegar	0.108
Chetwynd	0.147
Chilliwack	0.421
Comox	0.621
Courtenay	0.626
Cranbrook	0.138
Crescent Valley	0.108
Crofton	---
Dawson Creek	0.119
Dease Lake	0.148
Dog Creek	0.147
Duncan	---
Elko	0.169
Fernie	0.177
Fort Nelson	0.123
Fort St. John	0.117
Glacier	0.155
Gold River	---
Golden	0.189
Grand Forks	0.117
Greenwood	0.122
Hope	0.308
Jordan River	---
Kamloops	0.132
Kaslo	0.116
Kelowna	0.131
Kimberley	0.134
Kitimat Plant	0.197
Kitimat Townsite	0.197
Ladysmith	---
Langford	---
Lillooet	0.227
Lytton	0.241
Mackenzie	0.137
Masset	0.738
McBride	0.176
McLeod Lake	0.129
Merritt	0.187
Mission City	0.487
Montrose	0.108
Nakusp	0.111
Nanaimo	0.769
Nelson	0.123
Ocean Falls	0.219
Osyoos	0.159

Province and Location	$S_{a,ICF}$
Parksville	0.723
Penticton	0.146
Port Alberni	---
Port Alice	---
Port Hardy	0.605
Port McNeill	0.621
Port Renfrew	---
Powell River	0.523
Prince George	0.100
Prince Rupert	0.301
Princeton	0.221
Qualicum Beach	0.713
Queen Charlotte City	---
Quesnel	0.096
Revelstoke	0.118
Salmon Arm	0.114
Sandspit	---
Sechelt	0.615
Sidney	---
Smith River	0.414
Smithers	0.101
Sooke	---
Squamish	0.463
Stewart	0.185
Tahsis	---
Taylor	0.116
Terrace	0.175
Tofino	---
Trail	0.108
Ucluelet	---
<b>Vancouver Region</b>	
Burnaby (Simon Fraser Univ.)	0.554
Cloverdale	0.579
Haney	0.513
Ladner	0.662
Langley	0.559
New Westminster	0.574
North Vancouver	0.569
Richmond	0.631
Surrey (88 Ave & 156 St.)	0.569
Vancouver (City Hall)	0.605
Vancouver (Granville & 41 Ave)	0.615
West Vancouver	0.585
Vernon	0.118
<b>Victoria Region</b>	
Victoria (Gonzales Hts)	---
Victoria (Mt Tolmie)	---
Victoria	---
Whistler	0.351
White Rock	0.621
Williams Lake	0.118
Youbou	---
<b>Alberta</b>	
Athabasca	0.067
Banff	0.202
Barrhead	0.087
Beaverlodge	0.120
Brooks	0.091

Province and Location	$S_{a,ICF}$
Calgary	0.137
Campsie	0.090
Camrose	0.079
Canmore	0.201
Cardston	0.198
Claresholm	0.160
Cold Lake	0.053
Coleman	0.203
Coronation	0.070
Cowley	0.205
Drumheller	0.093
Edmonton	0.083
Edson	0.124
Embaras Portage	0.050
Fairview	0.097
Fort MacLeod	0.167
Fort McMurray	0.052
Fort Saskatchewan	0.075
Fort Vermilion	0.059
Grande Prairie	0.111
Habay	0.072
Hardisty	0.065
High River	0.150
Hinton	0.198
Jasper	0.204
Keg River	0.070
Lac la Biche	0.059
Lacombe	0.097
Lethbridge	0.126
Manning	0.077
Medicine Hat	0.077
Peace River	0.086
Pincher Creek	0.207
Ranfurly	0.064
Red Deer	0.101
Rocky Mountain House	0.130
Slave Lake	0.072
Stettler	0.086
Stony Plain	0.090
Suffield	0.084
Taber	0.106
Turner Valley	0.180
Valleyview	0.100
Vegreville	0.066
Vermilion	0.059
Wagner	0.073
Wainwright	0.062
Wetaskiwin	0.089
Whitecourt	0.098
Wimbome	0.101
<b>Saskatchewan</b>	
Assiniboia	0.112
Batrum	0.069
Biggar	0.060
Broadview	0.077
Dafoe	0.064
Dundurn	0.063
Estevan	0.105
Hudson Bay	0.053

Province and Location	$S_{a,ICF}$
Humboldt	0.060
Island Falls	0.047
Kamsack	0.059
Kindersley	0.063
Lloydminster	0.057
Maple Creek	0.071
Meadow Lake	0.052
Melfort	0.055
Melville	0.070
Moose Jaw	0.091
Nipawin	0.052
North Battleford	0.057
Prince Albert	0.054
Qu'Appelle	0.086
Regina	0.092
Rosetown	0.063
Saskatoon	0.061
Scott	0.059
Strasbourg	0.075
Swift Current	0.074
Uranium City	0.046
Weyburn	0.126
Yorkton	0.065
<b>Manitoba</b>	
Beausejour	0.048
Boissevain	0.058
Brandon	0.058
Churchill	0.047
Dauphin	0.055
Flin Flon	0.047
Gimli	0.048
Island Lake	0.048
Lac du Bonnet	0.049
Lynn Lake	0.047
Morden	0.049
Neepawa	0.055
Pine Falls	0.049
Portage la Prairie	0.050
Rivers	0.059
Sandilands	0.047
Selkirk	0.048
Split Lake	0.047
Steinbach	0.047
Swan River	0.055
The Pas	0.049
Thompson	0.047
Virten	0.065
Winnipeg	0.047
<b>Ontario</b>	
Ailsa Craig	0.109
Ajax	0.165
Alexandria	0.295
Alliston	0.135
Almonte	0.239
Armstrong	0.055
Arnprior	0.245
Atikokan	0.055
Attawapiskat	0.064

\*  $S_{a,ICF}$  is calculated by Tacoma Engineers to simplify the design tables, for more information please see note 1.12 in design limitation section. Note: A professional engineer must design the ICF walls for locations where the  $S_{a,ICF}$  is not provided.

Province and Location	S <sub>a,ICF</sub>
<b>Ontario</b>	
Aurora	0.145
Bancroft	0.181
Barrie	0.138
Barrie/field	0.189
Beaverton	0.147
Belleville	0.176
Belmont	0.119
Kitchenuhmay-kooisib (Big Trout Lake)	0.049
CFB Borden	0.135
Bracebridge	0.151
Bradford	0.141
Brampton	0.148
Brantford	0.138
Brighton	0.172
Brockville	0.226
Burk's Falls	0.164
Burlington	0.166
Cambridge	0.135
Campbellford	0.169
Cannington	0.149
Carleton Place	0.234
Cavan	0.158
Centralia	0.109
Chapleau	0.082
Chatham	0.110
Chesley	0.113
Clinton	0.106
Coboconk	0.155
Cobourg	0.168
Cochrane	0.138
Colborne	0.171
Collingwood	0.129
Cornwall	0.293
Corunna	0.098
Deep River	0.241
Deseronto	0.180
Dorchester	0.119
Dorion	0.051
Dresden	0.107
Dryden	0.059
Dundalk	0.125
Dunnville	0.158
Durham	0.117
Dutton	0.115
Earlton	0.163
Edison	0.057
Elm Lake	0.093
Elmvale	0.136
Embro	0.121
Englehart	0.159
Espanola	0.110
Exeter	0.109
Fenelon Falls	0.154
Fergus	0.129
Forest	0.103
Fort Erie	0.177

Province and Location	S <sub>a,ICF</sub>
Fort Erie (Ridgeway)	0.175
Fort Frances	0.052
Gananoque	0.199
Geraldton	0.053
Glencoe	0.111
Goderich	0.103
Gore Bay	0.094
Graham	0.057
Gravenhurst (Muskoka Airport)	0.148
Grimsby	0.174
Guelph	0.134
Guthrie	0.141
Haileybury	0.176
Haldimand (Caledonia)	0.153
Haldimand (Hagersville)	0.143
Haliburton	0.168
Halton Hills (Georgetown)	0.143
Hamilton	0.164
Hanover	0.114
Hastings	0.167
Hawkesbury	0.282
Hearst	0.074
Honey Harbour	0.139
Hornepayne	0.066
Huntsville	0.159
Ingersoll	0.122
Iroquois Falls	0.138
Jellicoe	0.053
Kapuskasing	0.097
Kemptville	0.257
Kenora	0.053
Killaloe	0.217
Kincardine	0.103
Kingston	0.189
Kinmount	0.159
Kirkland Lake	0.148
Kitchener	0.129
Lakeland	0.162
Lansdowne House	0.052
Leamington	0.109
Lindsay	0.154
Lion's Head	0.112
Listowel	0.116
London	0.116
Lucan	0.111
Maitland	0.231
Markdale	0.121
Markham	0.156
Martin	0.058
Matheson	0.136
Mattawa	0.241
Midland	0.137
Milton	0.151
Milverton	0.117
Minden	0.161
Mississauga	0.159
Mississauga (Lester B.	0.154

Province and Location	S <sub>a,ICF</sub>
Pearson Int'l A)	
Mississauga (Port Credit)	0.165
Mitchell	0.113
Moosonee	0.078
Morrisburg	0.281
Mount Forest	0.119
Nakina	0.054
Nanticoke (Jarvis)	0.138
Nanticoke (Port Dover)	0.134
Napanee	0.182
New Liskeard	0.173
Newcastle	0.165
Newcastle (Bowmanville)	0.165
Newmarket	0.144
Niagara Falls	0.181
North Bay	0.190
Norwood	0.166
Oakville	0.167
Orangeville	0.132
Orillia	0.144
Oshawa	0.164
Ottawa (City Hall)	0.265
Ottawa (Barrhaven)	0.261
Ottawa (Kanata)	0.254
Ottawa (M-C Int'l Airport)	0.266
Ottawa (Orleans)	0.272
Owen Sound	0.116
Pagwa River	0.061
Paris	0.134
Parkhill	0.107
Parry Sound	0.142
Pelham (Fonthill)	0.176
Pembroke	0.241
Penetanguishene	0.136
Perth	0.217
Petawawa	0.239
Peterborough	0.160
Petrolia	0.103
Pickering (Dunbarton)	0.166
Picton	0.175
Plattsville	0.126
Point Alexander	0.240
Port Burwell	0.125
Port Colborne	0.173
Port Elgin	0.107
Port Hope	0.167
Port Perry	0.153
Port Stanley	0.119
Prescott	0.246
Princeton	0.129
Raith	0.055
Rayside-Balfour (Chelmsford)	0.126
Red Lake	0.057
Renfrew	0.238
Richmond Hill	0.150
Rockland	0.277
Sarnia	0.098

Province and Location	S <sub>a,ICF</sub>
Sault Ste. Marie	0.071
Schreiber	0.052
Seaforth	0.109
Shelburne	0.129
Simcoe	0.133
Sioux Lookout	0.060
Smiths Falls	0.225
Smithville	0.172
Smooth Rock Falls	0.127
South River	0.171
Southampton	0.108
St. Catharines	0.179
St. Mary's	0.115
St. Thomas	0.118
Stirling	0.173
Stratford	0.118
Strathroy	0.110
Sturgeon Falls	0.169
Sudbury	0.131
Sundridge	0.168
Tavistock	0.121
Temagami	0.183
Thamesford	0.119
Theodford	0.104
Thunder Bay	0.051
Tillsonburg	0.125
Timmins	0.118
Timmins (Porcupine)	0.124
Etobicoke	0.155
North York	0.157
Scarborough	0.164
Toronto (City Hall)	0.168
Trenton	0.174
Trout Creek	0.176
Uxbridge	0.150
Vaughan (Woodbridge)	0.149
Vittoria	0.132
Walkerton	0.112
Wallaceburg	0.104
Waterloo	0.127
Watford	0.106
Wawa	0.066
Welland	0.175
West Lorne	0.115
Whitby	0.165
Whitby (Brooklin)	0.159
White River	0.063
Warton	0.113
Windsor	0.100
Wingham	0.109
Woodstock	0.124
Wyoming	0.102
<b>Quebec</b>	
Acton-Vale	0.245
Alma	0.358
Amos	0.143
Asbestos	0.236

\* S<sub>a,ICF</sub> is calculated by Tacoma Engineers to simplify the design tables, for more information please see note 1.12 in design limitation section. Note: A professional engineer must design the ICF walls for locations where the S<sub>a,ICF</sub> is not provided.

Province and Location	S <sub>a,ICF</sub>
<b>Quebec</b>	
Aylmer	0.259
Baie-Comeau	0.253
Baie-Saint-Paul	0.687
Beauport	0.306
Bedford	0.262
Beloil	0.283
Brome	0.237
Brossard	0.295
Buckingham	0.273
Campbell's Bay	0.248
Chambly	0.288
Coaticook	0.226
Contrecoeur	0.277
Cowansville	0.246
Deux-Montagnes	0.298
Dolbeau	0.275
Drummondville	0.251
Farnham	0.263
Fort-Coulonge	0.247
Gagnon	0.112
Gaspe	0.163
Gatineau	0.266
Gracefield	0.257
Granby	0.246
Harrington-Harbour	0.090
Havre-St-Pierre	0.164
Hemmingford	0.290
Hull	0.264
Iberville	0.284
Inukjuak	0.063
Joliette	0.275
Kuujuaq	0.089
Kuujuarapik	0.051
La Pocatiere	0.651
La-Malbaie	0.754
La-Tuque	0.240
Lac-Megantic	0.228
Lachute	0.284
Lennoxville	0.228
Lery	0.298
Loretteville	0.302
Louiseville	0.264
Magog	0.229
Malartic	0.160
Maniwaki	0.256
Masson	0.275
Matane	0.257
Mont-Joli	0.270
Mont-Laurier	0.254
Montmagny	0.338
<b>Montreal Region</b>	
Beaconsfield	0.299
Dorval	0.299
Laval	0.297
Montreal (City Hall)	0.297
Montreal-Est	0.295

Province and Location	S <sub>a,ICF</sub>
Montreal-Nord	0.296
Outremont	0.297
Pierrefonds	0.298
St-Lambert	0.295
St-Laurent	0.298
Ste-Anne-de-Bellevue	0.299
Verdun	0.297
Nicolet (Gentilly)	0.269
Nitchequon	0.075
Noranda	0.148
Perce	0.156
Pincourt	0.299
Ples s i s v i l e	0.253
Port-Cartier	0.212
Puvirnituaq	0.086
<b>Quebec City Region</b>	
Ancienne-Lorette	0.298
Levis	0.301
Quebec	0.301
Silery	0.298
Ste-Foy	0.299
Richmond	0.236
Rimouski	0.277
Riviere-du-Loup	0.483
Roberval	0.312
Rock-Island	0.227
Rosemere	0.296
Rouyn	0.149
Saguenay	0.369
Saguenay (Bagotville)	0.378
Saguenay (Jonquiere)	0.372
Saguenay (Kenogami)	0.372
Saint-Eustache	0.297
Saint-Jean-sur-Richelieu	0.285
Salaberry-de-Valleyfield	0.299
Schefferville	0.060
Senneterre	0.155
Sept-Iles	0.199
Shawinigan	0.258
Shawville	0.247
Sherbrooke	0.229
Sorel	0.269
St-Felicien	0.280
St-Georges-de-Cacouna	0.401
St-Hubert	0.294
Saint-Hubert-de-Riviere-du-Loup	0.307
St-Hyacinthe	0.263
St-Jerome	0.287
St-Jovite	0.265
St-Lazare-Hudson	0.298
St-Nicolas	0.292
Ste-Agathe-des-Monts	0.267
Sutton	0.238
Tadoussac	0.354
Terniscaming	0.334
Terrebonne	0.295

Province and Location	S <sub>a,ICF</sub>
Theftord Mines	0.243
Thurso	0.275
Trois-Rivieres	0.267
Val-d'Or	0.164
Varenes	0.292
Vercheres	0.286
Victoriaville	0.247
Ville-Marie	0.191
Wakefield	0.258
Waterloo	0.237
Windsor	0.232
<b>New Brunswick</b>	
Alma	0.169
Bathurst	0.200
Campbellton	0.216
Edmundston	0.252
Fredericton	0.207
Gagetown	0.197
Grand Falls	0.239
Miramichi	0.196
Moncton	0.172
Oromocto	0.204
Sackville	0.162
Saint Andrews	0.359
Saint George	0.270
Saint John	0.190
Shippagan	0.171
St. Stephen	0.321
Woodstock	0.219
<b>Nova Scotia</b>	
Amherst	0.157
Antigonish	0.140
Bridgewater	0.148
Canso	0.152
Debert	0.145
Digby	0.174
Greenwood (CFB)	0.160
Dartmouth	0.143
Halifax	0.143
Kentville	0.154
Liverpool	0.147
Lockeport	0.147
Louisburg	0.161
Lunenburg	0.147
New Glasgow	0.141
North Sydney	0.151
Pictou	0.141
Port Hawkesbury	0.145
Springhill	0.152
Stewiacke	0.144
Sydney	0.151
Tatamagouche	0.144
Truro	0.144
Wolfville	0.153
Yarmouth	0.160

Province and Location	S <sub>a,ICF</sub>
<b>Prince Edward Island</b>	
Charlottetown	0.143
Souris	0.136
Summerside	0.155
Tignish	0.158
<b>Newfoundland</b>	
Argentia	0.151
Bonavista	0.123
Buchans	0.115
Cape Harrison	0.149
Cape Race	0.161
Channel-Port aux Basques	0.133
Corner Brook	0.110
Gander	0.117
Grand Bank	0.167
Grand Falls	0.116
Happy Valley - Goose Bay	0.082
Labrador City	0.082
St. Anthony	0.093
St. John's	0.138
Stephenville	0.115
Twin Falls	0.073
Wabana	0.138
Wabush	0.083

\* S<sub>a,ICF</sub> is calculated by Tacoma Engineers to simplify the design tables, for more information please see note 1.12 in design limitation section. Note: A professional engineer must design the ICF walls for locations where the S<sub>a,ICF</sub> is not provided.

# Appendix B: Seismic Design Data for Selected Locations in Canada

**Table C-2**  
**Climatic Design Data for Selected Locations in Canada**

Province and Location	Elev., m	Design Temperature				Degree-Days Below 18°C	15 Min. Rain, mm	One Day Rain, 1/50, mm	Ann. Rain, mm	Moist. Index	Ann. Tot. Ppn., mm	Driving Rain Wind Pressures, Pa, 1/5	Snow Load, kPa, 1/50		Hourly Wind Pressures, kPa	
		January		July 2.5%									S <sub>s</sub>	S <sub>r</sub>	1/10	1/50
		2.5% °C	1% °C	Dry °C	Wet °C											
<b>British Columbia</b>																
100 Mile House	1040	-30	-32	29	17	5030	10	48	300	0.4	425	60	2.6	0.3	0.27	0.35
Abbotsford	70	-8	-10	29	20	2860	12	112	1525	1.6	1600	160	2.0	0.3	0.33	0.44
Agassiz	15	-9	-11	31	21	2750	8	128	1650	1.7	1700	160	2.4	0.7	0.35	0.47
Alberni	12	-5	-8	31	19	3100	10	144	1900	2.0	2000	220	2.6	0.4	0.24	0.32
Ashcroft	305	-24	-27	34	20	3700	10	37	250	0.3	300	80	1.7	0.1	0.29	0.38
Bamfield	20	-2	-4	23	17	3080	13	170	2870	3.0	2890	280	1.0	0.4	0.38	0.50
Beaton River	840	-37	-39	26	18	6300	15	64	330	0.5	450	80	3.3	0.1	0.23	0.30
Bella Bella	25	-5	-7	23	18	3180	13	145	2715	2.8	2800	350	2.6	0.8	0.40	0.50
Bella Coola	40	-14	-18	27	19	3560	10	140	1500	1.9	1700	350	4.5	0.8	0.29	0.39
Burns Lake	755	-31	-34	26	17	5450	12	54	300	0.6	450	100	3.4	0.2	0.29	0.39
Cache Creek	455	-24	-27	34	20	3700	10	37	250	0.3	300	80	1.7	0.2	0.29	0.39
Campbell River	20	-5	-7	26	18	3000	10	116	1500	1.6	1600	260	2.8	0.4	0.41	0.48
Carmi	845	-24	-26	31	19	4750	10	64	325	0.4	550	60	3.6	0.2	0.29	0.38
Castlegar	430	-18	-20	32	20	3580	10	54	560	0.6	700	60	4.2	0.1	0.26	0.34
Chetwynd	605	-35	-38	27	18	5500	15	70	400	0.6	625	60	2.4	0.2	0.30	0.40
Chilliwack	10	-9	-11	30	20	2780	8	139	1625	1.7	1700	160	2.2	0.3	0.35	0.47
Comox	15	-7	-9	27	18	2930	10	106	1175	1.3	1200	260	2.4	0.4	0.41	0.48
Courtenay	10	-7	-9	28	18	2930	10	106	1400	1.5	1450	260	2.4	0.4	0.41	0.48
Cranbrook	910	-26	-28	32	18	4400	12	59	275	0.3	400	100	3.0	0.2	0.25	0.33
Crescent Valley	585	-18	-20	31	20	3650	10	54	675	0.8	850	80	4.2	0.1	0.25	0.33
Crofton	5	-4	-6	28	19	2880	8	86	925	1.1	950	160	1.8	0.2	0.32	0.40
Dawson Creek	665	-38	-40	27	18	5900	18	75	325	0.5	475	100	2.5	0.2	0.30	0.40
Dease Lake	800	-37	-40	24	15	6730	10	45	265	0.6	425	50	2.8	0.1	0.23	0.30
Dog Creek	450	-28	-30	29	17	4800	10	48	275	0.4	375	100	1.8	0.2	0.27	0.35
Duncan	10	-6	-8	28	19	2980	8	103	1000	1.1	1050	180	1.8	0.4	0.31	0.39
Elko	1065	-28	-31	30	19	4600	13	64	440	0.5	650	100	3.6	0.2	0.30	0.40

Table C-2 (Continued)

Province and Location	Elev., m	Design Temperature				Degree-Days Below 18°C	15 Min. Rain, mm	One Day Rain, 1/50, mm	Ann. Rain, mm	Moist. Index	Ann. Tot. Ppr., mm	Driving Rain Wind Pressures, Pa, 1/5	Snow Load, kPa, 1/50		Hourly Wind Pressures, kPa	
		January	July	2.5% Wet °C	S <sub>s</sub>								S <sub>r</sub>	1/10	1/50	
																2.5% °C
Fernie	1010	-27	-30	30	19	4750	13	118	860	0.9	1175	100	4.5	0.2	0.30	0.40
Fort Nelson	465	-39	-42	28	18	6710	15	70	325	0.6	450	80	2.4	0.1	0.23	0.30
Fort St. John	685	-35	-37	26	18	5750	15	72	320	0.5	475	100	2.8	0.1	0.29	0.39
Glacier	1145	-27	-30	27	17	5800	10	70	625	0.8	1500	80	9.4	0.2	0.24	0.32
Golden	790	-27	-30	30	17	4750	10	55	325	0.6	500	100	3.7	0.2	0.26	0.35
Gold River	120	-8	-11	31	18	3230	13	200	2730	2.8	2850	250	2.8	0.6	0.24	0.32
Grand Forks	565	-19	-22	34	20	3820	10	48	390	0.5	475	80	2.8	0.1	0.30	0.40
Greenwood	745	-20	-23	34	20	4100	10	64	430	0.5	550	80	3.6	0.1	0.30	0.40
Hope	40	-13	-15	31	20	2820	8	139	1825	1.9	1900	140	2.8	0.7	0.47	0.63
Jordan River	20	-1	-3	22	17	2900	12	170	2300	2.4	2370	250	1.2	0.4	0.44	0.55
Kamloops	355	-23	-25	34	20	3450	13	42	225	0.2	275	80	1.8	0.2	0.30	0.40
Kaslo	545	-17	-20	30	19	3830	10	55	660	0.8	850	80	2.8	0.1	0.23	0.31
Kelowna	350	-17	-20	33	20	3400	12	43	260	0.3	325	80	1.7	0.1	0.30	0.40
Kimberley	1090	-25	-27	31	18	4650	12	59	350	0.4	500	100	3.0	0.2	0.25	0.33
Kitimat Plant	15	-16	-18	25	16	3750	13	193	2100	2.2	2500	220	5.5	0.8	0.36	0.48
Kitimat Townsite	130	-16	-18	24	16	3900	13	171	1900	2.0	2300	220	6.5	0.8	0.36	0.48
Ladysmith	80	-7	-9	27	19	2920	8	97	1075	1.2	1160	180	2.4	0.4	0.32	0.40
Langford	80	-4	-6	27	19	2750	9	135	1095	1.2	1125	220	1.8	0.3	0.32	0.40
Lillooet	245	-21	-23	34	20	3400	10	70	300	0.3	350	100	2.1	0.1	0.33	0.44
Lytton	325	-17	-20	35	20	3300	10	70	330	0.3	425	80	2.8	0.3	0.32	0.43
Mackenzie	765	-34	-38	27	17	5550	10	50	350	0.5	650	60	5.1	0.2	0.25	0.32
Masset	10	-5	-7	17	15	3700	13	80	1350	1.5	1400	400	1.8	0.4	0.50	0.61
McBride	730	-29	-32	29	18	4980	13	54	475	0.6	650	60	4.3	0.2	0.27	0.35
McLeod Lake	695	-35	-37	27	17	5450	10	50	350	0.5	650	60	4.1	0.2	0.25	0.32
Merritt	570	-24	-27	34	20	3900	8	54	240	0.2	310	80	1.8	0.3	0.33	0.44
Mission City	45	-9	-11	30	20	2850	13	123	1650	1.7	1700	160	2.4	0.3	0.32	0.43
Montrose	615	-16	-18	32	20	3600	10	54	480	0.6	700	60	4.1	0.1	0.26	0.35
Nakusp	445	-20	-22	31	20	3560	10	60	650	0.8	850	60	4.4	0.1	0.25	0.33

Table C-2 (Continued)

Table C-2 (Continued)

Province and Location	Elev., m	Design Temperature				Degree-Days Below 18°C	15 Min. Rain, mm	One Day Rain, 1/50, mm	Ann. Rain, mm	Moist. Index	Ann. Tot. Ppn., mm	Driving Rain Wind Pressures, Pa, 1/5	Snow Load, kPa, 1/50		Hourly Wind Pressures, kPa	
		January		July 2.5%									S <sub>s</sub>	S <sub>r</sub>	1/10	1/50
		2.5% °C	1% °C	Dry °C	Wet °C											
Nanaimo	15	-6	-8	27	19	2920	10	91	1000	1.1	1050	200	2.1	0.4	0.38	0.48
Nelson	600	-18	-20	31	20	3500	10	59	460	0.6	700	60	4.2	0.1	0.25	0.33
Ocean Falls	10	-10	-12	23	17	3400	13	260	4150	4.2	4300	350	3.9	0.8	0.44	0.59
Osoyoos	285	-14	-17	35	21	3100	10	48	275	0.3	310	60	1.1	0.1	0.30	0.40
Parksville	40	-6	-8	26	19	2990	10	91	1200	1.3	1250	200	2.0	0.4	0.40	0.48
Penticton	350	-15	-17	33	20	3350	10	48	275	0.3	300	60	1.3	0.1	0.30	0.40
Port Alberni	15	-5	-8	31	19	3100	10	161	1900	2.0	2000	240	2.6	0.4	0.24	0.32
Port Alice	25	-3	-6	26	17	3010	13	200	3300	3.4	3340	220	1.1	0.4	0.24	0.32
Port Hardy	5	-5	-7	20	16	3440	13	150	1775	1.9	1850	220	0.9	0.4	0.36	0.48
Port McNeill	5	-5	-7	22	17	3410	13	128	1750	1.9	1850	260	1.1	0.4	0.36	0.48
Port Renfrew	20	-3	-5	24	17	2900	13	200	3600	3.6	3675	270	1.1	0.4	0.42	0.52
Powell River	10	-7	-9	26	18	3100	10	80	1150	1.3	1200	220	1.7	0.4	0.39	0.48
Prince George	580	-32	-36	28	18	4720	15	54	425	0.6	600	80	3.4	0.2	0.28	0.37
Prince Rupert	20	-13	-15	19	15	3900	13	160	2750	2.8	2900	240	1.9	0.4	0.43	0.54
Princeton	655	-24	-29	33	19	4250	10	43	235	0.4	350	80	2.9	0.6	0.27	0.36
Qualicum Beach	10	-7	-9	27	19	2990	10	96	1200	1.3	1250	200	2.0	0.4	0.41	0.48
Queen Charlotte City	35	-6	-8	21	16	3520	13	110	1300	1.5	1350	360	1.8	0.4	0.50	0.61
Quesnel	475	-31	-33	30	17	4650	10	50	380	0.5	525	80	3.0	0.1	0.24	0.31
Revelstoke	440	-20	-23	31	19	4000	13	55	625	0.8	950	80	7.2	0.1	0.24	0.32
Salmon Arm	425	-19	-24	33	21	3650	13	48	400	0.5	525	80	3.5	0.1	0.29	0.39
Sandspit	5	-4	-6	18	15	3450	13	86	1300	1.5	1350	500	1.8	0.4	0.59	0.72
Sechelt	25	-6	-8	27	20	2880	10	75	1140	1.3	1200	160	1.8	0.4	0.38	0.48
Sidney	10	-4	-6	26	18	2850	8	96	825	1.0	850	160	1.1	0.2	0.34	0.42
Smithers	500	-29	-31	26	17	5040	13	60	325	0.6	500	120	3.5	0.2	0.30	0.40
Smith River	660	-45	-47	26	17	7100	10	64	300	0.6	500	40	2.8	0.1	0.24	0.30
Sooke	20	-1	-3	21	16	2900	9	130	1250	1.4	1280	220	1.3	0.3	0.38	0.48
Squamish	5	-9	-11	29	20	2950	10	140	2050	2.1	2200	160	2.8	0.7	0.38	0.50
Stewart	10	-17	-20	25	16	4350	13	135	1300	1.5	1900	180	7.9	0.8	0.27	0.36

Table C-2 (Continued)

Table C-2 (Continued)

Province and Location	Elev., m	Design Temperature				Degree-Days Below 18°C	15 Min. Rain, mm	One Day Rain, 1/50, mm	Ann. Rain, mm	Moist. Index	Ann. Tot. Ppn., mm	Driving Rain Wind Pressures, Pa, 1/5	Snow Load, kPa,		Hourly Wind Pressures, kPa	
		January		July 2.5%									S <sub>s</sub>	S <sub>t</sub>	1/10	1/50
		2.5% °C	1% °C	Dry °C	Wet °C											
Tahsis	25	-4	-6	26	18	3150	13	200	3845	3.9	3900	300	1.1	0.4	0.26	0.34
Taylor	515	-35	-37	26	18	5720	15	72	320	0.5	450	100	2.3	0.1	0.30	0.40
Terrace	60	-19	-21	27	17	4150	13	120	950	1.1	1150	200	5.4	0.6	0.27	0.36
Tofino	10	-2	-4	20	16	3150	13	193	3275	3.4	3300	300	1.1	0.4	0.51	0.68
Trail	440	-14	-17	33	20	3600	10	54	580	0.7	700	60	4.1	0.1	0.26	0.35
Ucluelet	5	-2	-4	18	16	3120	13	180	3175	3.3	3200	280	1.0	0.4	0.51	0.68
Vancouver Region																
Burnaby (Simon Fraser Univ.)	330	-7	-9	25	17	3100	10	150	1850	1.9	1950	160	2.9	0.7	0.35	0.47
Cloverdale	10	-8	-10	29	20	2700	10	112	1350	1.4	1400	160	2.5	0.2	0.33	0.44
Haney	10	-9	-11	30	20	2840	10	134	1800	1.9	1950	160	2.4	0.2	0.33	0.44
Ladner	3	-6	-8	27	19	2600	10	80	1000	1.1	1050	160	1.3	0.2	0.37	0.46
Langley	15	-8	-10	29	20	2700	10	112	1450	1.5	1500	160	2.4	0.2	0.33	0.44
New Westminster	10	-8	-10	29	19	2800	10	134	1500	1.6	1575	160	2.3	0.2	0.33	0.44
North Vancouver	135	-7	-9	26	19	2910	12	150	2000	2.1	2100	160	3.0	0.3	0.34	0.45
Richmond	5	-7	-9	27	19	2800	10	86	1070	1.2	1100	160	1.5	0.2	0.36	0.45
Surrey (88 Ave & 156 St.)	90	-8	-10	29	20	2750	10	128	1500	1.6	1575	160	2.4	0.3	0.33	0.44
Vancouver (City Hall)	40	-7	-9	28	20	2825	10	112	1325	1.4	1400	160	1.8	0.2	0.34	0.45
Vancouver (Granville St. & 41st Ave)	120	-6	-8	28	20	2925	10	107	1325	1.4	1400	160	1.9	0.3	0.36	0.45
West Vancouver	45	-7	-9	28	19	2950	12	150	1600	1.7	1700	160	2.4	0.2	0.36	0.48
Vernon	405	-20	-23	33	20	3600	13	43	350	0.4	400	80	2.2	0.1	0.30	0.40
Victoria Region																
Victoria	10	-4	-6	24	17	2650	8	91	800	1.0	825	220	1.1	0.2	0.46	0.57
Victoria (Gonzales Hts)	65	-4	-6	24	17	2700	9	91	600	0.8	625	220	1.5	0.3	0.46	0.57



Table C-2 (Continued)

Province and Location	Elev., m	Design Temperature				Degree-Days Below 18°C	15 Min. Rain, mm	One Day Rain, 1/50, mm	Ann. Rain, mm	Moist. Index	Ann. Tot. Ppn., mm	Driving Wind Pressures, Pa, 1/5	Snow Load, kPa, 1/50		Hourly Wind Pressures, kPa	
		January 2.5% °C	January 1% °C	July 2.5% Dry °C	July 2.5% Wet °C								S <sub>s</sub>	S <sub>r</sub>	1/10	1/50
Victoria (Mt Tolmie)	125	-6	-8	24	16	2700	9	91	775	1.0	800	220	2.1	0.3	0.46	0.57
Whistler	665	-17	-20	30	20	4180	10	85	845	1.0	1215	160	9.5	0.9	0.24	0.32
White Rock	30	-5	-7	25	20	2620	10	80	1065	1.2	1100	160	2.0	0.2	0.33	0.44
Williams Lake	615	-30	-33	29	17	4400	10	48	350	0.5	425	80	2.4	0.2	0.27	0.35
Youbou	200	-5	-8	31	19	3050	10	161	2000	2.1	2100	200	3.5	0.7	0.26	0.32
<b>Alberta</b>																
Athabasca	515	-35	-38	27	19	6000	18	86	370	0.6	480	80	1.5	0.1	0.27	0.36
Banff	1400	-31	-33	27	16	5500	18	65	300	0.6	500	120	3.3	0.1	0.26	0.32
Barrhead	645	-33	-36	27	19	5740	20	86	375	0.6	475	100	1.7	0.1	0.35	0.44
Beaverfodge	730	-36	-39	28	18	5700	20	86	315	0.5	470	100	2.4	0.1	0.27	0.36
Brooks	760	-32	-34	32	20	4880	18	86	260	0.3	340	220	1.2	0.1	0.35	0.44
Calgary	1045	-30	-32	28	17	5000	23	103	325	0.4	425	220	1.1	0.1	0.38	0.48
Campsie	660	-33	-36	27	19	5750	20	86	375	0.6	475	100	1.7	0.1	0.33	0.44
Camrose	740	-33	-35	29	19	5500	20	86	355	0.5	470	160	2.0	0.1	0.31	0.39
Canmore	1320	-31	-33	28	17	5400	18	86	325	0.6	500	120	3.2	0.1	0.30	0.37
Cardston	1130	-29	-32	30	19	4700	20	108	340	0.4	550	140	1.5	0.1	0.58	0.72
Claresholm	1030	-30	-32	30	18	4680	15	97	310	0.4	440	200	1.3	0.1	0.46	0.58
Cold Lake	540	-35	-38	28	19	5860	18	81	320	0.5	430	140	1.7	0.1	0.29	0.38
Coleman	1320	-31	-34	29	18	5210	15	86	400	0.5	550	120	2.7	0.3	0.50	0.63
Coronation	790	-32	-34	30	19	5640	20	92	300	0.5	400	200	1.9	0.1	0.30	0.37
Cowley	1175	-29	-32	29	18	4810	15	92	310	0.4	525	140	1.6	0.1	0.81	1.01
Drumheller	685	-32	-34	30	18	5050	20	86	300	0.4	375	220	1.2	0.1	0.35	0.44
Edmonton	645	-30	-33	28	19	5120	23	97	360	0.5	460	160	1.7	0.1	0.36	0.45
Edson	920	-34	-37	27	18	5750	18	81	450	0.6	570	100	2.1	0.1	0.37	0.46
Embaras Portage	220	-41	-43	28	19	7100	12	81	250	0.6	390	80	2.2	0.1	0.28	0.37
Fairview	670	-37	-40	27	18	5840	15	86	330	0.5	450	100	2.4	0.1	0.26	0.35
Fort MacLeod	945	-30	-32	31	19	4600	16	97	300	0.4	425	180	1.2	0.1	0.54	0.68

Table C-2 (Continued)

Table C-2 (Continued)

Province and Location	Elev., m	Design Temperature				Degree-Days Below 18°C	15 Min. Rain, mm	One Day Rain, 1/50, mm	Ann. Rain, mm	Moist. Index	Ann. Tot. Ppn., mm	Driving Wind Pressures, Pa, 1/5	Snow Load, kPa, 1/50		Hourly Wind Pressures, kPa	
		January		July 2.5%									S <sub>s</sub>	S <sub>r</sub>	1/10	1/50
		2.5% °C	1% °C	Dry °C	Wet °C											
Fort McMurray	255	-38	-40	28	19	6250	13	86	340	0.5	460	60	1.5	0.1	0.28	0.35
Fort Saskatchewan	610	-32	-35	28	19	5420	20	86	350	0.5	425	140	1.6	0.1	0.34	0.43
Fort Vermilion	270	-41	-43	28	18	6700	13	70	250	0.5	380	60	2.1	0.1	0.23	0.30
Grande Prairie	650	-36	-39	27	18	5790	20	86	315	0.5	450	120	2.2	0.1	0.32	0.43
Habay	335	-41	-43	28	18	6750	13	70	275	0.5	425	60	2.4	0.1	0.23	0.30
Hardisty	615	-33	-36	30	19	5640	20	81	325	0.5	425	140	1.7	0.1	0.29	0.36
High River	1040	-31	-32	28	17	4900	18	97	300	0.4	425	200	1.3	0.1	0.52	0.65
Hinton	990	-34	-38	27	17	5500	13	81	375	0.6	500	100	2.6	0.1	0.37	0.46
Jasper	1060	-31	-34	28	17	5300	12	76	300	0.5	400	80	3.0	0.1	0.26	0.32
Keg River	420	-40	-42	28	18	6520	13	70	310	0.5	450	80	2.4	0.1	0.23	0.30
Lac La Biche	560	-35	-38	28	19	6100	15	86	375	0.6	475	80	1.6	0.1	0.27	0.36
Lacombe	855	-33	-36	28	19	5500	23	92	350	0.5	450	180	1.9	0.1	0.32	0.40
Lethbridge	910	-30	-32	31	19	4500	20	97	250	0.3	390	200	1.2	0.1	0.53	0.66
Manning	465	-39	-41	27	18	6300	13	76	280	0.5	390	80	2.3	0.1	0.23	0.30
Medicine Hat	705	-31	-34	32	19	4540	23	92	250	0.3	325	220	1.1	0.1	0.38	0.48
Peace River	330	-37	-40	27	18	6050	15	81	300	0.5	390	100	2.2	0.1	0.24	0.32
Pincher Creek	1130	-29	-32	29	18	4740	16	103	325	0.4	575	140	1.5	0.1	0.77	0.96
Ranfurly	670	-34	-37	29	19	5700	18	92	325	0.5	420	100	1.9	0.1	0.29	0.36
Red Deer	855	-32	-35	28	19	5550	20	97	375	0.5	475	200	1.8	0.1	0.32	0.40
Rocky Mountain House	985	-32	-34	27	18	5640	20	92	425	0.6	550	120	1.9	0.1	0.29	0.36
Slave Lake	590	-35	-38	26	19	5850	15	81	380	0.6	500	80	1.9	0.1	0.28	0.37
Stettler	820	-32	-34	30	19	5300	20	97	370	0.5	450	200	1.9	0.1	0.29	0.36
Stony Plain	710	-32	-35	28	19	5300	23	97	410	0.5	540	120	1.7	0.1	0.36	0.45
Suffield	755	-31	-34	32	20	4770	20	86	230	0.2	325	220	1.3	0.1	0.39	0.49
Taber	815	-31	-33	31	19	4580	20	92	260	0.3	370	200	1.2	0.1	0.50	0.63
Turner Valley	1215	-31	-32	28	17	5220	20	97	350	0.5	600	180	1.4	0.1	0.52	0.65
Valleyview	700	-37	-40	27	18	5600	18	86	360	0.5	490	80	2.3	0.1	0.34	0.42
Vegreville	635	-34	-37	29	19	5780	18	86	325	0.5	410	100	1.9	0.1	0.29	0.36

Table C-2 (Continued)

Province and Location	Elev., m	Design Temperature				Degree-Days Below 18°C	15 Min. Rain, mm	One Day Rain, 1/50, mm	Ann. Rain, mm	Moist. Index	Ann. Tot. Ppn., mm	Driving Wind Pressures, Pa, 1/5	Snow Load, kPa, 1/50		Hourly Wind Pressures, kPa	
		January		July 2.5%									S <sub>s</sub>	S <sub>r</sub>	1/10	1/50
		2.5% °C	1% °C	Dry °C	Wet °C											
Vermilion	580	-35	-38	29	19	5740	18	86	310	0.5	410	100	1.7	0.1	0.29	0.36
Wagner	585	-35	-38	26	19	5850	15	81	380	0.6	500	80	1.9	0.1	0.28	0.37
Wainwright	675	-33	-36	29	19	5700	20	81	310	0.5	425	120	2.0	0.1	0.29	0.36
Weiskiwini	760	-33	-35	29	19	5500	23	86	400	0.6	500	160	2.0	0.1	0.31	0.39
Whitecourt	690	-33	-36	27	19	5650	20	97	440	0.6	550	80	1.9	0.1	0.28	0.37
Wimborne	975	-31	-34	29	18	5310	23	92	325	0.5	450	200	1.6	0.1	0.32	0.40
<b>Saskatchewan</b>																
Assiniboia	740	-32	-34	31	21	5180	25	81	290	0.3	375	240	1.6	0.1	0.39	0.49
Batroum	700	-32	-34	32	20	5080	23	81	270	0.4	350	260	1.2	0.1	0.43	0.54
Biggar	645	-34	-36	30	20	5720	23	81	270	0.4	350	180	2.1	0.1	0.36	0.45
Broadview	600	-34	-35	30	21	5760	25	103	320	0.5	420	160	1.7	0.1	0.36	0.46
Datoc	530	-35	-37	29	21	5860	20	92	300	0.5	380	140	1.7	0.1	0.29	0.37
Dundurn	525	-35	-37	30	21	5600	23	86	275	0.4	380	180	1.5	0.1	0.36	0.46
Estevan	565	-32	-34	32	22	5340	28	92	330	0.4	420	200	1.6	0.1	0.41	0.52
Hudson Bay	370	-36	-38	29	21	6280	20	81	340	0.6	450	80	2.0	0.1	0.29	0.37
Humboldt	565	-36	-38	28	21	6000	20	86	320	0.5	375	140	2.1	0.1	0.31	0.39
Island Falls	305	-39	-41	27	20	7100	18	76	370	0.6	510	80	2.1	0.1	0.26	0.35
Kamsack	455	-34	-37	29	22	6040	20	97	360	0.6	450	120	2.1	0.2	0.32	0.40
Kindersley	685	-33	-35	31	20	5550	23	81	260	0.4	325	200	1.4	0.1	0.36	0.46
Lloydminster	645	-34	-37	28	20	5880	18	81	310	0.5	430	120	2.0	0.1	0.32	0.40
Maple Creek	765	-31	-34	31	20	4780	25	81	275	0.3	380	220	1.2	0.1	0.36	0.45
Meadow Lake	480	-38	-40	28	20	6280	18	81	320	0.5	450	120	1.7	0.1	0.30	0.40
Melfort	455	-36	-38	28	21	6050	20	81	310	0.5	410	120	2.1	0.1	0.28	0.36
Melville	550	-34	-36	29	21	5880	23	97	340	0.5	410	160	1.7	0.1	0.32	0.40
Moose Jaw	545	-32	-34	31	21	5270	25	86	270	0.3	360	200	1.4	0.1	0.41	0.52
Nipawin	365	-37	-39	28	21	6300	20	76	340	0.6	450	100	2.0	0.1	0.30	0.38
North Battleford	545	-34	-36	29	20	5900	20	81	280	0.5	370	120	1.7	0.1	0.36	0.46
Prince Albert	435	-37	-40	28	21	6100	20	81	320	0.5	410	140	1.9	0.1	0.30	0.38

Table C-2 (Continued)

Table C-2 (Continued)

Province and Location	Elev., m	Design Temperature				Degree-Days Below 18°C	15 Min. Rain, mm	One Day Rain, 1/50, mm	Ann. Rain, mm	Moist. Index	Ann. Tot. Ppn., mm	Driving Rain Wind Pressures, Pa, 1/5	Snow Load, kPa, 1/50		Hourly Wind Pressures, kPa	
		January		July 2.5%									S <sub>s</sub>	S <sub>t</sub>	1/10	1/50
		2.5% °C	1% °C	Dry °C	Wet °C											
Qu'Appelle	645	-34	-36	30	22	5620	25	97	340	0.5	430	160	1.7	0.1	0.33	0.42
Regina	575	-34	-36	31	21	5600	28	103	300	0.4	365	200	1.4	0.1	0.39	0.49
Rosetown	595	-34	-36	31	20	5620	23	81	260	0.4	330	200	1.7	0.1	0.39	0.49
Saskatoon	500	-35	-37	30	21	5700	23	86	265	0.4	350	160	1.7	0.1	0.36	0.46
Scott	645	-34	-36	30	20	5960	20	81	270	0.4	360	140	1.9	0.1	0.36	0.45
Strasbourg	545	-34	-36	30	22	5600	25	92	300	0.4	390	180	1.5	0.1	0.33	0.42
Swift Current	750	-31	-34	31	20	5150	25	81	260	0.3	350	240	1.4	0.1	0.43	0.54
Uranium City	265	-42	-44	26	19	7500	12	54	300	0.6	360	100	2.0	0.1	0.27	0.36
Weyburn	575	-33	-35	31	23	5400	28	97	320	0.4	400	200	1.8	0.1	0.38	0.48
Yorkton	510	-34	-37	29	21	6000	23	97	350	0.5	440	140	1.9	0.1	0.32	0.40
<b>Manitoba</b>																
Beausejour	245	-33	-35	29	23	5680	28	103	430	0.6	530	180	2.0	0.2	0.32	0.41
Boissevain	510	-32	-34	30	23	5500	28	119	390	0.5	510	180	2.2	0.2	0.41	0.52
Brandon	395	-33	-35	30	22	5760	28	108	375	0.6	460	180	2.1	0.2	0.39	0.49
Churchill	10	-38	-40	25	18	8950	12	76	265	0.8	410	260	3.0	0.2	0.43	0.55
Dauphin	295	-33	-35	30	22	5900	28	103	400	0.6	490	160	1.9	0.2	0.32	0.40
Flin Flon	300	-38	-40	27	20	6440	18	81	340	0.6	475	80	2.2	0.2	0.28	0.35
Gimli	220	-34	-36	29	23	5800	28	108	410	0.7	530	180	1.9	0.2	0.32	0.40
Island Lake	240	-36	-38	27	20	6900	18	86	380	0.7	550	80	2.6	0.2	0.29	0.37
Lac du Bonnet	260	-34	-36	29	23	5730	28	103	445	0.7	560	180	1.9	0.2	0.29	0.37
Lynn Lake	350	-40	-42	27	19	7770	18	86	310	0.6	490	100	2.4	0.2	0.29	0.37
Morden	300	-31	-33	30	24	5400	28	119	420	0.6	520	180	2.2	0.2	0.41	0.52
Neepawa	365	-32	-34	29	23	5760	28	108	410	0.6	470	180	2.2	0.2	0.35	0.44
Pine Falls	220	-34	-36	28	23	5900	25	97	440	0.7	420	180	1.9	0.2	0.31	0.39
Portage la Prairie	260	-31	-33	30	23	5600	28	108	390	0.5	525	180	2.1	0.2	0.36	0.46
Rivers	465	-34	-36	29	23	5840	28	108	370	0.6	460	180	2.1	0.2	0.36	0.46
Sandilands	365	-32	-34	29	23	5650	28	113	460	0.6	550	180	2.2	0.2	0.32	0.40
Selkirk	225	-33	-35	29	23	5700	28	108	420	0.6	500	180	1.9	0.2	0.32	0.41

Table C-2 (Continued)

Table C-2 (Continued)

Province and Location	Elev., m	Design Temperature				Degree-Days Below 18°C	15 Min. Rain, mm	One Day Rain, 1/50, mm	Ann. Rain, mm	Moist. Index	Ann. Tot. Ppn., mm	Driving Wind Pressures, Pa, 1/5	Snow Load, kPa, 1/50		Hourly Wind Pressures, kPa	
		January		July 2.5%									S <sub>s</sub>	S <sub>r</sub>	1/10	1/50
		2.5% °C	1% °C	Dry °C	Wet °C											
Split Lake	175	-38	-40	27	19	7900	18	76	325	0.7	500	120	2.5	0.2	0.31	0.39
Steinbach	270	-33	-35	29	23	5700	28	108	440	0.6	500	180	2.0	0.2	0.32	0.40
Swan River	335	-34	-37	29	22	6100	20	92	370	0.6	500	120	2.0	0.2	0.28	0.35
The Pas	270	-36	-38	28	21	6480	18	81	330	0.6	450	160	2.2	0.2	0.29	0.37
Thompson	205	-40	-43	27	19	7600	18	86	350	0.6	540	100	2.4	0.2	0.28	0.36
Virten	435	-33	-35	30	23	5620	28	108	350	0.5	460	180	2.0	0.2	0.36	0.46
Winnipeg	235	-33	-35	30	23	5670	28	108	415	0.6	500	180	1.9	0.2	0.36	0.45
<b>Ontario</b>																
Alisa Craig	230	-17	-19	30	23	3840	25	103	800	0.9	950	180	2.2	0.4	0.37	0.48
Ajax	95	-20	-22	30	23	3820	23	92	760	0.9	825	160	1.0	0.4	0.37	0.48
Alexandria	80	-24	-26	30	23	4600	25	103	800	0.9	975	160	2.4	0.4	0.31	0.40
Alliston	220	-23	-25	29	23	4200	28	113	690	0.8	875	120	2.0	0.4	0.28	0.36
Almonte	120	-26	-28	30	23	4620	25	97	730	0.8	800	140	2.5	0.4	0.32	0.41
Armstrong	340	-37	-40	28	21	6500	23	97	525	0.8	725	100	2.7	0.4	0.22	0.30
Arnprior	85	-27	-29	30	23	4680	23	86	630	0.8	775	140	2.5	0.4	0.29	0.37
Atikokan	400	-33	-35	29	22	5750	25	103	570	0.8	760	100	2.4	0.3	0.22	0.30
Attawapiskat	10	-37	-39	28	21	7100	18	81	450	0.8	650	160	2.8	0.3	0.30	0.41
Aurora	270	-21	-23	30	23	4210	28	108	700	0.8	800	140	2.0	0.4	0.34	0.44
Bancroft	365	-28	-31	29	23	4740	25	92	720	0.9	900	100	3.1	0.4	0.25	0.32
Barrie	245	-24	-26	29	23	4380	28	97	700	0.8	900	120	2.5	0.4	0.28	0.36
Barrie/field	100	-22	-24	28	23	3990	23	108	780	1.0	950	160	2.1	0.4	0.37	0.47
Beaverton	240	-24	-26	30	23	4300	25	108	720	0.9	950	120	2.2	0.4	0.28	0.36
Belleville	90	-22	-24	29	23	3910	23	97	760	0.9	850	180	1.7	0.4	0.34	0.43
Belmont	260	-17	-19	30	24	3840	25	97	850	1.0	950	180	1.7	0.4	0.37	0.47
Borden (CFB)	225	-23	-25	29	23	4300	28	103	690	0.82	875	120	2.2	0.4	0.28	0.36
Bracebridge	310	-26	-28	29	23	4800	25	103	830	1.0	1050	120	3.1	0.4	0.27	0.35
Bradford	240	-23	-25	30	23	4280	28	108	680	0.8	800	120	2.1	0.4	0.28	0.36
Brampton	215	-19	-21	30	23	4100	28	119	720	0.8	820	140	1.3	0.4	0.34	0.44

Table C-2 (Continued)

Table C-2 (Continued)

Province and Location	Elev., m	Design Temperature				Degree-Days Below 18°C	15 Min. Rain, mm	One Day Rain, 1/50, mm	Ann. Rain, mm	Moist. Index	Ann. Tot. Ppn., mm	Driving Rain Wind Pressures, Pa, 1/5	Snow Load, kPa, 1/50		Hourly Wind Pressures, kPa	
		January		July 2.5%									S <sub>s</sub>	S <sub>t</sub>	1/10	1/50
		2.5% °C	1% °C	Dry °C	Wet °C											
Brantford	205	-18	-20	30	23	3900	23	103	780	0.9	850	160	1.3	0.4	0.33	0.42
Brighton	95	-21	-23	29	23	4000	23	94	760	0.9	850	160	1.6	0.4	0.37	0.48
Brockville	85	-23	-25	29	23	4060	25	103	770	0.9	975	180	2.2	0.4	0.34	0.44
Burk's Falls	305	-26	-28	29	22	5020	25	97	810	0.9	1010	120	2.7	0.4	0.27	0.35
Burlington	80	-17	-19	31	23	3740	23	103	770	0.9	850	160	1.1	0.4	0.36	0.46
Cambridge	295	-18	-20	29	23	4100	25	113	800	0.9	890	160	1.6	0.4	0.28	0.36
Campbellford	150	-23	-26	30	23	4280	25	97	730	0.9	850	160	1.7	0.4	0.32	0.41
Cannington	255	-24	-26	30	23	4310	25	108	740	0.9	950	120	2.2	0.4	0.28	0.36
Carleton Place	135	-25	-27	30	23	4600	25	97	730	0.8	850	160	2.5	0.4	0.32	0.41
Cavan	200	-23	-25	30	23	4400	25	97	740	0.9	850	140	2.0	0.4	0.34	0.44
Centralia	260	-17	-19	30	23	3800	25	103	820	1.0	1000	180	2.3	0.4	0.37	0.48
Chapleau	425	-35	-38	27	21	5900	20	97	530	0.7	850	80	3.6	0.4	0.23	0.30
Chatham	180	-16	-18	31	24	3470	28	103	800	0.9	850	180	1.0	0.4	0.34	0.43
Chesley	275	-19	-21	29	22	4320	28	103	810	0.9	1125	140	2.8	0.4	0.35	0.45
Clinton	280	-17	-19	29	23	4150	25	103	810	0.9	1000	160	2.6	0.4	0.36	0.46
Coboconk	270	-25	-27	30	23	4500	25	108	740	0.9	950	120	2.5	0.4	0.27	0.35
Cobourg	90	-21	-23	29	23	3980	23	94	760	0.9	825	160	1.2	0.4	0.38	0.49
Cochrane	245	-34	-36	29	21	6200	20	92	575	0.8	875	80	2.8	0.3	0.27	0.35
Colborne	105	-21	-23	29	23	3980	23	94	760	0.9	850	160	1.6	0.4	0.38	0.49
Collingwood	190	-21	-23	29	23	4180	28	97	720	0.9	950	160	2.7	0.4	0.30	0.39
Cornwall	35	-23	-25	30	23	4250	25	103	780	0.9	960	180	2.2	0.4	0.32	0.41
Corunna	185	-16	-18	31	24	3600	25	100	760	0.9	800	180	1.0	0.4	0.37	0.47
Deep River	145	-29	-32	30	22	4900	23	92	650	0.8	850	100	2.5	0.4	0.27	0.35
Deseronto	85	-22	-24	29	23	4070	23	92	760	0.9	900	160	1.9	0.4	0.34	0.43
Dorchester	260	-18	-20	30	24	3900	28	103	850	1.0	950	180	1.9	0.4	0.37	0.47
Dorion	200	-33	-35	28	21	5950	20	103	550	0.8	725	160	2.8	0.4	0.29	0.39
Dresden	185	-16	-18	31	24	3750	28	97	760	0.8	820	180	1.0	0.4	0.34	0.43
Dryden	370	-34	-36	28	22	5850	25	97	550	0.7	700	120	2.4	0.3	0.22	0.30

Table C-2 (Continued)

Province and Location	Elev., m	Design Temperature				Degree-Days Below 18°C	15 Min. Rain, mm	One Day Rain, 1/50, mm	Ann. Rain, mm	Moist. Index	Ann. Tot. Ppn., mm	Driving Wind Pressures, Pa, 1/5	Snow Load, kPa, 1/50		Hourly Wind Pressures, kPa	
		January		July 2.5%									S <sub>s</sub>	S <sub>r</sub>	1/10	1/50
		2.5% °C	1% °C	Dry °C	Wet °C											
Dundalk	525	-22	-24	29	22	4700	28	108	750	0.9	1080	150	3.2	0.4	0.33	0.42
Dunnville	175	-15	-17	30	24	3660	23	108	830	1.0	950	160	2.0	0.4	0.36	0.46
Durham	340	-20	-22	29	22	4340	28	103	815	0.9	1025	140	2.8	0.4	0.34	0.44
Dutton	225	-16	-18	31	24	3700	28	92	850	1.0	925	180	1.3	0.4	0.37	0.47
Earlton	245	-33	-36	29	22	5730	23	92	560	0.8	820	120	3.1	0.4	0.35	0.45
Edison	365	-34	-36	28	22	5740	25	108	510	0.7	680	120	2.4	0.3	0.23	0.31
Elliot Lake	380	-26	-28	29	21	4950	23	108	630	0.8	950	160	2.9	0.4	0.30	0.38
Elmvale	220	-24	-26	29	23	4200	28	97	720	0.9	950	140	2.6	0.4	0.28	0.36
Embro	310	-19	-21	30	23	3950	28	113	830	0.9	950	160	2.0	0.4	0.37	0.48
Englehart	205	-33	-36	29	22	5800	23	92	600	0.8	880	100	2.8	0.4	0.32	0.41
Espanola	220	-25	-27	29	21	4920	23	108	650	0.8	840	160	2.3	0.4	0.33	0.42
Exeter	265	-17	-19	30	23	3900	25	113	810	0.9	975	180	2.4	0.4	0.37	0.48
Fenelon Falls	260	-25	-27	30	23	4440	25	108	730	0.9	950	120	2.3	0.4	0.28	0.36
Fergus	400	-20	-22	29	23	4300	28	108	760	0.9	925	160	2.2	0.4	0.28	0.36
Forest	215	-16	-18	31	23	3740	25	103	810	1.0	875	160	2.0	0.4	0.37	0.48
Fort Erie	180	-15	-17	30	24	3650	23	108	860	1.0	1020	160	2.3	0.4	0.36	0.46
Fort Erie (Ridgeway)	190	-15	-17	30	24	3600	25	108	860	1.0	1000	160	2.3	0.4	0.36	0.46
Fort Frances	340	-33	-35	29	22	5440	25	108	570	0.7	725	120	2.3	0.3	0.23	0.31
Gananoque	80	-22	-24	28	23	4010	23	103	760	0.9	900	180	2.1	0.4	0.37	0.47
Geraldton	345	-36	-39	28	21	6450	20	86	550	0.8	725	100	2.9	0.4	0.22	0.30
Glencoe	215	-16	-18	31	24	3680	28	103	800	0.9	925	180	1.5	0.4	0.34	0.43
Goderich	185	-16	-18	29	23	4000	25	92	810	1.0	950	180	2.4	0.4	0.37	0.48
Gore Bay	205	-24	-26	28	22	4700	23	92	640	0.8	860	160	2.6	0.4	0.34	0.44
Graham	495	-35	-37	29	22	5940	23	97	570	0.8	750	140	2.6	0.3	0.22	0.30
Gravenhurst (Muskoka Airport)	255	-26	-28	29	23	4760	25	103	790	0.9	1050	120	2.7	0.4	0.28	0.36
Grimsby	85	-16	-18	30	23	3520	23	108	760	0.9	875	160	0.9	0.4	0.36	0.46
Guelph	340	-19	-21	29	23	4270	28	103	770	0.9	875	140	1.9	0.4	0.28	0.36

Table C-2 (Continued)

Table C-2 (Continued)

Province and Location	Elev., m	Design Temperature				Degree-Days Below 18°C	15 Min. Rain, mm	One Day Rain, 1/50, mm	Ann. Rain, mm	Moist. Index	Ann. Tot. Ppn., mm	Driving Rain Wind Pressures, Pa, 1/5	Snow Load, kPa, 1/50		Hourly Wind Pressures, kPa	
		January		July 2.5%									S <sub>s</sub>	S <sub>r</sub>	1/10	1/50
		2.5% °C	1% °C	Dry °C	Wet °C											
Guthrie	280	-24	-26	29	23	4300	28	103	700	0.8	950	120	2.5	0.4	0.28	0.36
Halleybury	210	-32	-35	30	22	5600	23	92	590	0.8	820	120	2.4	0.4	0.34	0.44
Haldimand (Caledonia)	190	-18	-20	30	23	3750	23	108	810	0.9	875	160	1.2	0.4	0.34	0.44
Haldimand (Hagersville)	215	-17	-19	30	23	3760	25	97	840	1.0	875	160	1.3	0.4	0.36	0.46
Haliburton	335	-27	-29	29	23	4840	25	92	780	0.9	980	100	2.9	0.4	0.27	0.35
Halton Hills (Georgetown)	255	-19	-21	30	23	4200	28	119	750	0.8	850	140	1.4	0.4	0.29	0.37
Hamilton	90	-17	-19	31	23	3460	23	108	810	0.9	875	160	1.1	0.4	0.36	0.46
Hanover	270	-19	-21	29	22	4300	28	103	790	0.9	1050	140	2.6	0.4	0.34	0.44
Hastings	200	-24	-26	30	23	4280	25	92	730	0.9	840	140	2.0	0.4	0.32	0.41
Hawkesbury	50	-25	-27	30	23	4610	23	103	800	0.9	925	160	2.3	0.4	0.32	0.41
Hearst	245	-35	-37	29	21	6450	20	86	520	0.7	825	80	2.8	0.3	0.23	0.30
Honey Harbour	180	-24	-26	29	23	4300	25	97	710	0.9	1050	160	2.7	0.4	0.30	0.39
Hornepayne	360	-37	-40	28	21	6340	20	93	420	0.7	750	80	3.3	0.4	0.22	0.30
Huntsville	335	-26	-29	29	22	4850	25	103	800	0.9	1000	120	2.9	0.4	0.27	0.35
Ingersoll	280	-18	-20	30	23	3920	28	108	840	1.0	950	180	1.7	0.4	0.37	0.48
Iroquois Falls	275	-33	-36	29	21	6100	20	86	575	0.8	825	100	2.9	0.3	0.29	0.37
Jellicoe	330	-36	-39	28	21	6400	20	86	550	0.8	750	100	2.7	0.4	0.22	0.30
Kapuskeing	245	-34	-36	29	21	6250	20	86	550	0.8	825	100	3.0	0.3	0.24	0.31
Kemptville	90	-25	-27	30	23	4540	25	92	750	0.9	925	160	2.3	0.4	0.32	0.41
Kenora	370	-33	-35	28	22	5630	25	113	515	0.6	630	120	2.5	0.3	0.23	0.31
Killaloe	185	-28	-31	30	22	4960	23	86	680	0.8	825	120	2.7	0.4	0.27	0.35
Kincardine	190	-17	-19	28	22	3890	25	92	800	1.0	950	180	2.6	0.4	0.37	0.48
Kingston	80	-22	-24	28	23	4000	23	108	780	1.0	950	180	2.1	0.4	0.37	0.47
Kinmount	295	-26	-28	29	23	4600	25	108	750	0.9	950	120	2.7	0.4	0.27	0.35
Kirkland Lake	325	-33	-36	29	22	6000	23	92	600	0.8	875	100	2.9	0.3	0.30	0.39



Table C-2 (Continued)

Table C-2 (Continued)

Province and Location	Elev., m	Design Temperature				Degree-Days Below 18°C	15 Min. Rain, mm	One Day Rain, 1/50, mm	Ann. Rain, mm	Moist. Index	Ann. Tot. Ppn., mm	Driving Wind Pressures, Pa, 1/5	Snow Load, kPa, 1/50		Hourly Wind Pressures, kPa	
		January		July 2.5%									S <sub>s</sub>	S <sub>r</sub>	1/10	1/50
		2.5% °C	1% °C	Dry °C	Wet °C											
Kitchener	335	-19	-21	29	23	4200	28	119	780	0.9	925	140	2.0	0.4	0.29	0.37
Kitchenuhmaykoosib / Big Trout Lake	215	-38	-40	26	20	7450	18	92	400	0.75	600	150	3.2	0.2	0.31	0.42
Lakefield	240	-24	-26	30	23	4330	25	92	720	0.9	850	140	2.2	0.4	0.30	0.38
Lansdowne House	240	-38	-40	28	21	7150	23	92	500	0.8	680	140	3.0	0.2	0.24	0.32
Leamington	190	-15	-17	31	24	3400	28	113	800	0.9	875	180	0.8	0.4	0.37	0.47
Lindsay	265	-24	-26	30	23	4320	25	103	720	0.8	850	140	2.3	0.4	0.30	0.38
Lion's Head	185	-19	-21	27	22	4300	25	103	700	0.9	950	180	2.7	0.4	0.37	0.48
Listowel	380	-19	-21	29	23	4300	28	119	800	0.9	1000	160	2.6	0.4	0.34	0.43
London	245	-18	-20	30	24	3900	28	103	825	0.9	975	180	1.9	0.4	0.37	0.47
Lucan	300	-17	-19	30	23	3900	25	113	810	0.9	1000	180	2.3	0.4	0.37	0.48
Maitland	85	-23	-25	29	23	4080	25	103	770	0.9	975	180	2.2	0.4	0.34	0.44
Markdale	425	-20	-22	29	22	4500	28	103	820	0.9	1050	160	3.2	0.4	0.32	0.41
Markham	175	-21	-23	31	24	4000	25	86	720	0.8	825	140	1.3	0.4	0.34	0.44
Martin	485	-35	-37	29	22	5900	25	103	560	0.8	750	120	2.6	0.3	0.22	0.30
Matheson	265	-33	-36	29	21	6080	20	86	580	0.8	825	100	2.8	0.3	0.30	0.39
Mattawa	165	-29	-31	30	22	5050	23	86	700	0.9	875	100	2.1	0.4	0.25	0.32
Midland	190	-24	-26	29	23	4200	25	97	740	0.9	1060	160	2.7	0.4	0.30	0.39
Milton	200	-18	-20	30	23	3920	25	125	750	0.9	850	160	1.3	0.4	0.34	0.43
Milverton	370	-19	-21	29	23	4200	28	108	800	0.9	1050	160	2.4	0.4	0.34	0.43
Minden	270	-27	-29	29	23	4640	25	97	780	0.9	1010	100	2.7	0.4	0.27	0.35
Mississauga	160	-18	-20	30	23	3880	25	113	720	0.9	800	160	1.1	0.4	0.34	0.44
Mississauga (Lester B. Pearson Int'l Airport)	170	-20	-22	31	24	3890	26	108	685	0.8	790	160	1.1	0.4	0.34	0.44
Mississauga (Port Credit)	75	-18	-20	29	23	3780	25	108	720	0.9	800	160	0.9	0.4	0.37	0.48
Mitchell	335	-18	-20	29	23	4100	28	113	810	0.9	1050	160	2.4	0.4	0.35	0.45
Moosonee	10	-36	-38	28	22	6800	18	81	500	0.8	700	160	2.7	0.3	0.26	0.35
Morrisburg	75	-23	-25	30	23	4370	25	103	800	0.9	950	180	2.3	0.4	0.32	0.41

Table C-2 (Continued)

Table C-2 (Continued)

Province and Location	Elev., m	Design Temperature				Degree-Days Below 18°C	15 Min. Rain, mm	One Day Rain, 1/50, mm	Ann. Rain, mm	Moist. Index	Ann. Tot. Ppn., mm	Driving Rain Wind Pressures, Pa, 1/5	Snow Load, kPa, 1/50		Hourly Wind Pressures, kPa	
		January		July 2.5%									S <sub>s</sub>	S <sub>r</sub>	1/10	1/50
		2.5°C	1% °C	Dry °C	Wet °C											
Mount Forest	420	-21	-24	28	22	4700	28	103	740	0.9	940	140	2.7	0.4	0.32	0.41
Nakina	325	-36	-38	28	21	6500	20	86	540	0.8	750	100	2.8	0.4	0.22	0.30
Nanicoke (Jarvis)	205	-17	-18	30	23	3700	28	108	840	1.0	900	160	1.4	0.4	0.37	0.48
Nanicoke (Port Dover)	180	-15	-17	30	24	3600	25	108	860	1.0	950	140	1.2	0.4	0.37	0.48
Napanee	90	-22	-24	29	23	4140	23	92	770	0.9	900	160	1.9	0.4	0.34	0.43
Newcastle	115	-20	-22	30	23	3990	23	86	760	0.9	830	160	1.5	0.4	0.37	0.48
Newcastle (Bowmanville)	95	-20	-22	30	23	4000	23	86	760	0.90	830	160	1.4	0.4	0.37	0.48
New Liskeard	180	-32	-35	30	22	5570	23	92	570	0.8	810	100	2.6	0.4	0.34	0.43
Newmarket	185	-22	-24	30	23	4260	28	108	700	0.8	800	140	2.0	0.4	0.30	0.38
Niagara Falls	210	-16	-18	30	23	3600	23	96	810	0.9	950	160	1.8	0.4	0.34	0.43
North Bay	210	-28	-30	28	22	5150	25	95	775	0.9	975	120	2.2	0.4	0.27	0.34
Norwood	225	-24	-26	30	23	4320	25	92	720	0.8	850	120	2.1	0.4	0.32	0.41
Oakville	90	-18	-20	30	23	3760	23	97	750	0.9	850	160	1.1	0.4	0.37	0.47
Orangeville	430	-21	-23	29	23	4450	28	108	730	0.8	875	140	2.3	0.4	0.28	0.36
Orillia	230	-25	-27	29	23	4260	25	103	740	0.9	1000	120	2.4	0.4	0.28	0.36
Oshawa	110	-19	-21	30	23	3860	23	86	760	0.9	875	160	1.4	0.4	0.37	0.48
Ottawa (Metropolitan)																
Ottawa (Barrhaven)	98	-25	-27	30	23	4500	25	92	750	0.8	900	160	2.4	0.4	0.32	0.41
Ottawa (City Hall)	70	-25	-27	30	23	4440	23	86	750	0.8	900	160	2.4	0.4	0.32	0.41
Ottawa (Kanata)	98	-25	-27	30	23	4520	25	92	730	0.8	900	160	2.5	0.4	0.32	0.41
Ottawa (M-C Int'l Airport)	125	-25	-27	30	23	4500	24	89	750	0.8	900	160	2.4	0.4	0.32	0.41
Ottawa (Orléans)	70	-26	-28	30	23	4500	23	91	750	0.8	900	160	2.4	0.4	0.32	0.41
Owen Sound	215	-19	-21	29	22	4030	28	113	760	0.9	1075	160	2.8	0.4	0.34	0.44
Pagwa River	185	-35	-37	28	21	6500	20	86	540	0.8	825	80	2.7	0.4	0.22	0.30
Paris	245	-18	-20	30	23	4000	23	96	790	0.9	925	160	1.4	0.4	0.33	0.42
Parkhill	205	-16	-18	31	23	3800	25	103	800	0.9	925	180	2.1	0.4	0.37	0.48

Table C-2 (Continued)

Table C-2 (Continued)

Province and Location	Elev., m	Design Temperature				Degree-Days Below 18°C	15 Min. Rain, mm	One Day Rain, 1/50, mm	Ann. Rain, mm	Moist. Index	Ann. Tot. Ppn., mm	Driving Wind Pressures, Pa, 1/5	Snow Load, kPa, 1/50		Hourly Wind Pressures, kPa	
		January		July 2.5%									S <sub>s</sub>	S <sub>r</sub>	1/10	1/50
		2.5% °C	1% °C	Dry °C	Wet °C											
Parry Sound	215	-24	-26	28	22	4640	23	97	820	1.0	1050	160	2.8	0.4	0.30	0.39
Pelham (Fonthill)	230	-15	-17	30	23	3690	23	96	820	0.9	950	160	2.1	0.4	0.33	0.42
Pembroke	125	-28	-31	30	23	4980	23	105	640	0.8	825	100	2.5	0.4	0.27	0.35
Penetanguishene	220	-24	-26	29	23	4200	25	97	720	0.9	1050	160	2.8	0.4	0.30	0.39
Perth	130	-25	-27	30	23	4540	25	92	730	0.8	900	140	2.3	0.4	0.32	0.41
Petawawa	135	-29	-31	30	23	4980	23	92	640	0.8	825	100	2.6	0.4	0.27	0.35
Peterborough	200	-23	-25	30	23	4400	25	92	710	0.8	840	140	2.0	0.4	0.32	0.41
Petrolia	195	-16	-18	31	24	3640	25	108	810	0.9	920	180	1.3	0.4	0.37	0.47
Pickering (Dunbarton)	85	-19	-21	30	23	3800	23	92	730	0.9	825	140	1.0	0.4	0.37	0.48
Pictou	95	-21	-23	29	23	3980	23	92	770	0.9	940	160	2.0	0.4	0.38	0.49
Plattsville	300	-19	-21	29	23	4150	28	103	820	0.9	950	140	1.9	0.4	0.33	0.42
Point Alexander	150	-29	-32	30	22	4960	23	92	650	0.8	850	100	2.5	0.4	0.27	0.35
Port Burwell	195	-15	-17	30	24	3800	25	92	930	1.1	1000	180	1.2	0.4	0.37	0.47
Port Colborne	180	-15	-17	30	24	3600	23	108	850	1.0	1000	160	2.1	0.4	0.36	0.46
Port Elgin	205	-17	-19	28	22	4100	25	92	790	0.9	850	180	2.8	0.4	0.37	0.48
Port Hope	100	-21	-23	29	23	3970	23	94	760	0.9	825	180	1.2	0.4	0.37	0.48
Port Perry	270	-22	-24	30	23	4260	25	97	720	0.8	850	140	2.4	0.4	0.34	0.44
Port Stanley	180	-15	-17	31	24	3850	25	92	940	1.1	975	180	1.2	0.4	0.37	0.47
Prescott	90	-23	-25	29	23	4120	25	103	770	0.9	975	180	2.2	0.4	0.34	0.44
Princeton	280	-18	-20	30	23	4000	25	97	810	0.9	925	160	1.5	0.4	0.33	0.42
Raith	475	-34	-37	28	22	5900	23	97	570	0.8	750	120	2.7	0.4	0.22	0.30
Rayside-Balfour (Chelmsford)	270	-28	-30	29	21	5200	25	92	650	0.8	850	180	2.5	0.4	0.35	0.45
Red Lake	360	-35	-37	28	21	6220	20	92	470	0.7	630	120	2.6	0.3	0.22	0.30
Renfrew	115	-27	-30	30	23	4900	23	97	620	0.8	810	140	2.5	0.4	0.27	0.35
Richmond Hill	230	-21	-23	31	24	4000	25	97	740	0.8	850	140	1.5	0.4	0.34	0.44
Rockland	50	-26	-28	30	23	4600	23	92	780	0.9	950	160	2.4	0.4	0.31	0.40

Table C-2 (Continued)

Table C-2 (Continued)

Province and Location	Elev., m	Design Temperature				Degree-Days Below 18°C	15 Min. Rain, mm	One Day Rain, 1/50, mm	Ann. Rain, mm	Moist. Index	Ann. Tot. Ppn., mm	Driving Wind Pressures, Pa, 1/5	Snow Load, kPa, 1/50		Hourly Wind Pressures, kPa	
		January		July 2.5%									S <sub>s</sub>	S <sub>r</sub>	1/10	1/50
		2.5% °C	1% °C	Dry °C	Wet °C											
Sarnia	190	-16	-18	31	24	3750	25	100	750	0.9	825	180	1.1	0.4	0.37	0.47
Sault Ste. Marie	190	-25	-28	29	22	4960	23	97	660	0.9	950	200	3.1	0.4	0.33	0.44
Schreiber	310	-34	-36	27	21	5960	20	103	600	0.8	850	160	3.3	0.4	0.29	0.39
Seaforth	310	-17	-19	30	23	4100	25	108	810	0.9	1025	160	2.5	0.4	0.35	0.45
Shelburne	495	-22	-24	29	23	4700	28	108	740	0.9	900	150	3.1	0.4	0.31	0.40
Simcoe	210	-17	-19	30	24	3700	28	113	860	1.0	950	160	1.3	0.4	0.35	0.45
Sioux Lookout	375	-34	-36	28	22	5950	25	97	520	0.7	710	100	2.6	0.3	0.22	0.30
Smiths Falls	130	-25	-27	30	23	4540	25	92	730	0.8	850	140	2.3	0.4	0.32	0.41
Smithville	185	-16	-18	30	23	3650	23	108	800	0.9	900	160	1.5	0.4	0.33	0.42
Smooth Rock Falls	235	-34	-36	29	21	6250	20	92	560	0.8	850	80	2.7	0.3	0.25	0.32
Southampton	180	-17	-19	28	22	4100	25	92	800	1.0	830	180	2.7	0.4	0.37	0.48
South River	355	-27	-29	29	22	5090	25	103	830	1.0	975	120	2.8	0.4	0.27	0.35
St. Catharines	105	-16	-18	30	23	3540	23	92	770	0.9	850	160	1.0	0.4	0.36	0.46
St. Marys	310	-18	-20	30	23	4000	28	108	820	1.0	1025	160	2.2	0.4	0.37	0.47
St. Thomas	225	-16	-18	31	24	3780	25	103	900	1.0	975	180	1.4	0.4	0.37	0.47
Stirling	120	-23	-25	30	23	4220	25	97	740	0.9	850	120	1.7	0.4	0.31	0.40
Stratford	360	-18	-20	29	23	4050	28	113	820	1.0	1050	160	2.3	0.4	0.35	0.45
Strathroy	225	-17	-19	31	24	3780	25	103	770	0.9	950	180	1.9	0.4	0.37	0.47
Sturgeon Falls	205	-28	-30	29	21	5200	25	95	700	0.9	910	140	2.4	0.4	0.27	0.35
Sturbury	275	-28	-30	29	21	5180	25	97	650	0.8	875	200	2.5	0.4	0.36	0.46
Sundridge	340	-27	-29	29	22	5080	25	97	840	1.0	975	120	2.8	0.4	0.27	0.35
Tavistock	340	-19	-21	29	23	4100	28	113	820	1.0	1010	160	2.1	0.4	0.35	0.45
Temagami	300	-30	-33	30	22	5420	23	92	650	0.8	875	120	2.6	0.4	0.29	0.37
Thamesford	280	-19	-21	30	23	3950	28	108	820	0.9	975	160	1.9	0.4	0.37	0.48
Thedford	205	-16	-18	31	23	3710	25	103	810	1.0	900	180	2.1	0.4	0.37	0.48
Thunder Bay	210	-31	-33	29	21	5650	23	108	560	0.8	710	160	2.9	0.4	0.29	0.39
Tillsonburg	215	-17	-19	30	24	3840	25	103	880	1.0	980	160	1.3	0.4	0.34	0.44

Table C-2 (Continued)

Province and Location	Elev., m	Design Temperature				Degree-Days Below 18°C	15 Min. Rain, mm	One Day Rain, 1/50, mm	Ann. Rain, mm	Moist. Index	Ann. Tot. Ppn., mm	Driving Wind Pressures, Pa, 1/5	Snow Load, kPa, 1/50		Hourly Wind Pressures, kPa	
		January		July 2.5%									S <sub>s</sub>	S <sub>r</sub>	1/10	1/50
		2.5% °C	1% °C	Dry °C	Wet °C											
Timmins	300	-34	-36	29	21	5940	20	108	560	0.8	875	100	3.1	0.3	0.27	0.35
Timmins (Porcupine)	295	-34	-36	29	21	6000	20	103	560	0.8	875	100	2.9	0.3	0.29	0.37
Toronto Metropolitan Region																
Etobicoke	160	-20	-22	31	24	3800	26	108	720	0.8	800	160	1.1	0.4	0.34	0.44
North York	175	-20	-22	31	24	3760	25	108	730	0.8	850	150	1.2	0.4	0.34	0.44
Scarborough	180	-20	-22	31	24	3800	25	92	730	0.9	825	160	1.2	0.4	0.37	0.47
Toronto (City Hall)	90	-18	-20	31	23	3520	25	97	720	0.9	820	160	0.9	0.4	0.34	0.44
Trenton	80	-22	-24	29	23	4110	23	97	760	0.9	850	160	1.6	0.4	0.37	0.47
Trout Creek	330	-27	-29	29	22	5100	25	103	780	0.9	975	120	2.7	0.4	0.27	0.35
Uxbridge	275	-22	-24	30	23	4240	25	103	700	0.8	850	140	2.4	0.4	0.33	0.42
Vaughan (Woodbridge)	165	-20	-22	31	24	4100	26	113	700	0.8	800	140	1.1	0.4	0.34	0.44
Vittoria	215	-15	-17	30	24	3680	25	113	880	1.0	950	160	1.3	0.4	0.37	0.47
Walkerton	275	-18	-20	30	22	4300	28	103	790	0.9	1025	160	2.7	0.4	0.36	0.46
Wallaceburg	180	-16	-18	31	24	3600	28	97	760	0.9	825	180	0.9	0.4	0.35	0.45
Waterloo	330	-19	-21	29	23	4200	28	119	780	0.9	925	160	2.0	0.4	0.29	0.37
Watford	240	-17	-19	31	24	3740	25	108	790	0.9	950	160	1.9	0.4	0.37	0.47
Wawa	290	-34	-36	26	21	5840	20	93	725	0.9	950	160	3.4	0.4	0.30	0.39
Welland	180	-15	-17	30	23	3670	23	103	840	1.0	975	160	2.0	0.4	0.34	0.43
West Lorne	215	-16	-18	31	24	3700	28	103	840	1.0	900	180	1.3	0.4	0.37	0.47
Whitby	85	-20	-22	30	23	3820	23	86	760	0.9	850	160	1.2	0.4	0.37	0.48
Whitby (Brooklin)	160	-20	-22	30	23	4010	23	86	770	0.9	850	140	1.9	0.4	0.35	0.45
White River	375	-39	-42	28	21	6150	20	92	575	0.8	825	100	3.6	0.4	0.22	0.30
Warton	185	-19	-21	29	22	4300	25	103	740	0.9	1000	180	2.7	0.4	0.34	0.44
Windsor	185	-16	-18	32	24	3400	28	103	800	0.9	900	180	0.8	0.4	0.37	0.47
Wingham	310	-18	-20	30	23	4220	28	108	780	0.9	1050	160	2.6	0.4	0.36	0.46
Woodstock	300	-19	-21	30	23	3910	28	113	830	0.9	930	160	1.9	0.4	0.34	0.44

Table C-2 (Continued)

Table C-2 (Continued)

Province and Location	Elev., m	Design Temperature				Degree-Days Below 18°C	15 Min. Rain, mm	One Day Rain, 1/50, mm	Ann. Rain, mm	Moist. Index	Ann. Tot. Ppn., mm	Driving Wind Pressures, Pa, 1/5	Snow Load, kPa, 1/50		Hourly Wind Pressures, kPa	
		January		July 2.5%									S <sub>s</sub>	S <sub>r</sub>	1/10	1/50
		2.5% °C	1% °C	Dry °C	Wet °C											
Wyoming	215	-16	-18	31	24	3700	25	103	815	0.9	900	180	1.6	0.4	0.37	0.47
<b>Quebec</b>																
Acton Vale	95	-24	-27	30	23	4620	21	107	860	1.0	1050	180	2.3	0.4	0.27	0.35
Alma	110	-31	-33	28	22	5800	20	91	700	0.9	950	160	3.3	0.4	0.27	0.35
Amos	295	-34	-36	28	21	6160	20	91	670	0.9	920	100	3.2	0.3	0.25	0.32
Asbestos	245	-26	-28	29	22	4800	23	96	870	1.0	1050	160	2.8	0.6	0.27	0.35
Aylmer	90	-25	-28	30	23	4520	23	91	730	0.8	900	160	2.5	0.4	0.32	0.41
Baie-Comeau	60	-27	-29	25	19	6020	16	91	680	1.0	1000	220	4.3	0.4	0.39	0.50
Baie-Saint-Paul	20	-27	-29	28	21	5280	18	102	730	0.9	1000	180	3.4	0.6	0.37	0.48
Beaufort	45	-26	-29	28	22	5100	20	107	980	1.1	1200	200	3.4	0.6	0.33	0.42
Bedford	55	-24	-26	29	23	4420	23	91	880	1.0	1260	160	2.1	0.4	0.29	0.37
Belœil	25	-24	-26	30	23	4500	23	91	840	1.0	1025	180	2.4	0.4	0.29	0.37
Brome	210	-25	-27	29	23	4730	23	96	990	1.1	1240	160	2.5	0.4	0.29	0.37
Brossard	15	-24	-26	30	23	4420	23	91	800	0.9	1025	180	2.4	0.4	0.34	0.44
Buckingham	130	-26	-28	30	23	4880	23	91	810	0.9	990	160	2.6	0.4	0.31	0.40
Campbell's Bay	115	-28	-30	30	23	4900	23	96	700	0.8	850	140	2.6	0.4	0.25	0.32
Chambly	20	-24	-26	30	23	4450	23	91	850	1.0	1000	160	2.3	0.4	0.31	0.40
Coaticook	295	-25	-27	28	22	4750	23	96	860	1.0	1060	160	2.3	0.6	0.27	0.35
Contrecoeur	10	-25	-27	30	23	4500	20	102	810	0.9	1000	180	2.8	0.4	0.34	0.43
Cowansville	120	-25	-27	29	23	4540	23	91	940	1.0	1150	160	2.3	0.4	0.29	0.37
Deux-Montagnes	25	-25	-27	29	23	4440	23	96	820	0.9	1025	160	2.4	0.4	0.29	0.37
Dolbeau	120	-32	-34	28	22	6250	22	91	670	0.9	900	140	3.5	0.3	0.27	0.35
Drummondville	85	-26	-28	30	23	4700	22	107	870	1.0	1075	180	2.5	0.4	0.27	0.35
Farnham	60	-24	-26	29	23	4500	23	96	910	1.0	1050	180	2.5	0.4	0.29	0.37
Fort-Coulonge	110	-28	-30	30	23	4950	23	96	720	0.9	900	100	2.5	0.4	0.25	0.32
Gagnon	545	-34	-36	24	19	7600	17	80	580	0.9	925	140	4.6	0.4	0.30	0.39
Gaspé	55	-25	-26	26	20	5500	19	118	760	1.0	1100	300	4.3	0.6	0.37	0.48
Gatineau	95	-25	-28	30	23	4600	23	91	790	0.9	950	160	2.5	0.4	0.32	0.41

Table C-2 (Continued)

Province and Location	Elev., m	Design Temperature				Degree-Days Below 18°C	15 Min. Rain, mm	One Day Rain, 1/50, mm	Ann. Rain, mm	Moist. Index	Ann. Tot. Ppn., mm	Driving Wind Pressures, Pa, 1/5	Snow Load, kPa, 1/50		Hourly Wind Pressures, kPa	
		January		July 2.5%									S <sub>s</sub>	S <sub>r</sub>	1/10	1/50
		2.5% °C	1% °C	Dry °C	Wet °C											
Gracefield	175	-28	-31	30	23	5080	23	96	700	0.9	950	140	2.6	0.4	0.25	0.32
Granby	120	-25	-27	29	23	4500	23	102	940	1.0	1175	160	2.3	0.4	0.27	0.35
Harrington Harbour	30	-27	-29	19	16	6150	15	96	900	1.2	1150	300	4.9	0.6	0.56	0.72
Havre-Saint-Pierre	5	-27	-29	22	18	6100	15	96	780	1.1	1125	300	4.1	0.6	0.49	0.63
Hemmingford	75	-24	-26	30	23	4380	23	91	770	0.9	1025	160	2.4	0.4	0.31	0.40
Hull	65	-25	-28	30	23	4550	23	91	730	0.8	900	160	2.4	0.4	0.32	0.41
Iberville	35	-24	-26	29	23	4450	23	91	880	1.0	1010	160	2.2	0.4	0.32	0.41
Inukjuak	5	-36	-38	21	15	9150	9	54	270	0.9	420	240	4.1	0.2	0.37	0.48
Joliette	45	-26	-28	29	23	4720	21	102	790	0.9	1000	160	3.1	0.4	0.28	0.36
Kuujuuaq	25	-37	-39	24	17	8550	9	54	280	0.8	525	260	4.8	0.2	0.47	0.60
Kuujuuarapik	20	-36	-38	25	17	7990	12	80	410	0.9	610	180	4.2	0.3	0.37	0.48
Lachute	65	-26	-28	29	23	4640	23	96	910	1.0	1075	160	2.4	0.4	0.31	0.40
Lac-Mégantic	420	-27	-29	27	22	5180	23	91	790	0.9	1025	160	3.2	0.6	0.27	0.35
La Malbaie	25	-26	-28	28	21	5400	18	102	640	0.8	900	180	3.1	0.6	0.37	0.48
La Pocatière	55	-24	-26	28	22	5160	18	102	675	0.9	965	180	3.2	0.6	0.39	0.50
La Tuque	165	-30	-32	29	22	5500	23	96	720	0.9	930	160	3.4	0.4	0.27	0.35
Lennoxville	155	-28	-30	29	22	4700	23	96	850	1.0	1100	160	2.1	0.6	0.25	0.32
Léry	30	-24	-26	29	23	4420	23	91	800	0.9	950	180	2.3	0.4	0.33	0.42
Loretteville	100	-26	-29	28	22	5200	20	102	980	1.1	1225	200	3.7	0.6	0.32	0.41
Louiseville	15	-25	-28	29	23	4900	20	102	800	0.9	1025	160	2.9	0.4	0.34	0.43
Magog	215	-26	-28	29	23	4730	23	96	860	1.0	1125	160	2.3	0.4	0.27	0.35
Malartic	325	-33	-36	29	21	6200	20	86	640	0.8	900	100	3.3	0.3	0.25	0.32
Maniwaki	180	-30	-32	29	22	5280	23	96	700	0.9	900	100	2.4	0.4	0.24	0.31
Masson	50	-26	-28	30	23	4610	23	91	790	0.9	975	160	2.4	0.4	0.31	0.40
Matane	5	-24	-26	24	20	5510	18	91	640	0.9	1050	220	3.7	0.4	0.43	0.55
Mont-Joli	90	-24	-26	26	21	5370	18	91	610	0.8	920	220	4.1	0.4	0.41	0.52
Mont-Laurier	225	-29	-32	29	22	5320	24	102	790	0.9	1000	160	2.6	0.4	0.23	0.30
Montmagny	10	-25	-28	28	22	5090	20	102	880	1.0	1090	180	2.9	0.6	0.37	0.47

Table C-2 (Continued)

Table C-2 (Continued)

Province and Location	Elev., m	Design Temperature				Degree-Days Below 18°C	15 Min. Rain, mm	One Day Rain, 1/50, mm	Ann. Rain, mm	Moist. Index	Ann. Tot. Ppn., mm	Driving Wind Pressures, Pa, 1/5	Snow Load, kPa, 1/50		Hourly Wind Pressures, kPa	
		January		July 2.5%									S <sub>s</sub>	S <sub>r</sub>	1/10	1/50
		2.5% °C	1% °C	Dry °C	Wet °C											
Montréal Region																
Beaconsfield	25	-24	-26	30	23	4440	23	91	780	0.9	950	180	2.3	0.4	0.33	0.42
Dorval	25	-24	-26	30	23	4400	23	91	760	0.9	940	180	2.4	0.4	0.34	0.44
Laval	35	-24	-26	29	23	4500	23	96	830	0.9	1025	160	2.6	0.4	0.33	0.42
Montréal (City Hall)	20	-23	-26	30	23	4200	23	96	830	0.93	1025	180	2.6	0.4	0.34	0.44
Montréal-Est	25	-23	-26	30	23	4470	23	96	830	0.93	1025	180	2.7	0.4	0.34	0.44
Montréal-Nord	20	-24	-26	30	23	4470	23	96	830	0.93	1025	160	2.6	0.4	0.33	0.42
Outremont	105	-23	-26	30	23	4300	23	96	820	0.91	1025	180	2.8	0.4	0.34	0.44
Pierrefonds	25	-24	-26	30	23	4430	23	96	800	0.90	960	180	2.4	0.4	0.33	0.42
Sainte-Anne-de-Bellevue	35	-24	-26	29	23	4460	23	96	780	0.9	960	180	2.3	0.4	0.33	0.42
Saint-Lambert	15	-23	-26	30	23	4400	23	96	810	0.91	1050	160	2.5	0.4	0.34	0.44
Saint-Laurent	45	-23	-26	30	23	4270	23	96	790	0.89	950	160	2.5	0.4	0.34	0.44
Verdun	20	-23	-26	30	23	4200	23	91	780	0.9	1025	180	2.5	0.4	0.34	0.44
Nicolet (Gentilly)	15	-25	-28	29	23	4900	20	107	860	1.0	1025	160	2.8	0.4	0.33	0.42
Nitchequon	545	-39	-41	23	19	8100	15	70	500	0.9	825	140	3.5	0.3	0.29	0.37
Noranda	305	-33	-36	29	21	6050	20	91	650	0.8	875	100	3.2	0.3	0.27	0.35
Percé	5	-21	-24	25	19	5400	16	107	1000	1.2	1300	300	3.8	0.6	0.49	0.63
Pincourt	25	-24	-26	29	23	4480	23	96	780	0.9	950	180	2.3	0.4	0.33	0.42
Plessisville	145	-26	-28	29	23	5100	21	107	890	1.0	1150	180	2.8	0.6	0.27	0.35
Port-Cartier	20	-28	-30	25	19	6060	15	106	730	1.0	1125	300	4.1	0.4	0.42	0.54
Puvirnituq	5	-36	-38	23	16	9200	7	54	210	0.9	375	240	4.5	0.2	0.47	0.60
Québec City Region																
Ancienne-Lorette	35	-25	-28	28	23	5130	20	102	940	1.1	1200	200	3.4	0.6	0.32	0.41
Lévis	50	-25	-28	28	22	5050	20	107	920	1.0	1200	160	3.3	0.6	0.32	0.41
Québec	120	-25	-28	28	22	5080	20	107	925	1.0	1210	200	3.6	0.6	0.32	0.41
Sainte-Foy	115	-25	-28	28	23	5100	20	107	940	1.1	1200	180	3.7	0.6	0.32	0.41
Sillery	10	-25	-28	28	23	5070	20	107	930	1.1	1200	200	3.1	0.6	0.32	0.41



Table C-2 (Continued)

Table C-2 (Continued)

Province and Location	Elev., m	Design Temperature				Degree-Days Below 18°C	15 Min. Rain, mm	One Day Rain, 1/50, mm	Ann. Rain, mm	Moist. Index	Ann. Tot. Ppn., mm	Driving Rain Wind Pressures, Pa, 1/5	Snow Load, kPa, 1/50		Hourly Wind Pressures, kPa	
		January		July 2.5%									S <sub>s</sub>	S <sub>r</sub>	1/10	1/50
		2.5°C	1°C	Dry °C	Wet °C											
Richmond	150	-25	-27	29	22	4700	23	96	870	1.0	1060	160	2.4	0.6	0.25	0.32
Rimouski	30	-25	-27	26	20	5300	18	91	640	0.8	890	200	3.8	0.4	0.41	0.52
Rivière-du-Loup	55	-25	-27	26	21	5380	18	91	660	0.8	900	180	3.5	0.6	0.39	0.50
Roberval	100	-31	-33	28	21	5750	22	91	590	0.8	910	140	3.5	0.3	0.27	0.35
Rock Island	160	-25	-27	29	23	4850	23	91	900	1.0	1125	160	2.0	0.4	0.27	0.35
Rosemère	25	-24	-26	29	23	4550	23	96	840	1.0	1050	160	2.6	0.4	0.31	0.40
Rouyn	300	-33	-36	29	21	6050	20	91	650	0.8	900	100	3.1	0.3	0.27	0.35
Saguenay	10	-30	-32	28	22	5700	18	86	710	0.9	975	140	2.7	0.4	0.28	0.36
Saguenay (Bagotville)	5	-31	-33	28	21	5700	18	86	690	0.9	925	160	2.7	0.4	0.30	0.38
Saguenay (Jonquière)	135	-30	-32	28	22	5650	18	86	710	0.9	925	160	3.1	0.4	0.27	0.35
Saguenay (Kénogami)	140	-30	-32	28	22	5650	18	86	690	0.9	925	160	3.1	0.4	0.27	0.35
Sainte-Agathe-des-Monts	360	-28	-30	28	22	5390	23	96	820	1.0	1170	140	3.4	0.4	0.27	0.35
Saint-Eustache	35	-25	-27	29	23	4500	23	96	820	0.9	1025	160	2.4	0.4	0.29	0.37
Saint-Félicien	105	-32	-34	28	22	5850	22	91	570	0.8	900	140	3.5	0.3	0.27	0.35
Saint-Georges-de-Cacouna	35	-25	-27	26	21	5400	18	91	660	0.9	925	180	3.2	0.6	0.39	0.50
Saint-Hubert	25	-24	-26	30	23	4490	23	91	820	0.9	1020	180	2.5	0.4	0.34	0.44
Saint-Hubert-de-Rivière-du-Loup	310	-26	-28	26	21	5520	22	91	740	0.9	1025	180	4.4	0.6	0.31	0.40
Saint-Hyacinthe	35	-24	-27	30	23	4500	21	91	840	1.0	1030	160	2.3	0.4	0.27	0.35
Saint-Jean-sur-Richelieu	35	-24	-26	29	23	4450	23	91	880	1.0	1010	180	2.2	0.4	0.32	0.41
Saint-Jérôme	95	-26	-28	29	23	4820	23	96	830	1.0	1025	160	2.7	0.4	0.29	0.37
Saint-Jovite	230	-29	-31	28	22	5250	23	96	810	1.0	1025	160	2.8	0.4	0.26	0.33
Saint-Lazare / Hudson	60	-24	-26	30	23	4520	23	96	750	0.9	950	180	2.3	0.4	0.33	0.42
Saint-Nicolas	65	-25	-28	28	22	4990	20	102	890	1.0	1200	200	3.5	0.6	0.33	0.42
Salaberry-de-Valleyfield	50	-23	-25	29	23	4400	23	96	760	0.9	900	180	2.3	0.4	0.33	0.42

Table C-2 (Continued)

Table C-2 (Continued)

Province and Location	Elev., m	Design Temperature				Degree-Days Below 18°C	15 Min. Rain, mm	One Day Rain, 1/50, mm	Ann. Rain, mm	Moist. Index	Ann. Tot. Ppn., mm	Driving Wind Pressures, Pa, 1/5	Snow Load, kPa, 1/50		Hourly Wind Pressures, kPa	
		January		July 2.5%									S <sub>s</sub>	S <sub>r</sub>	1/10	1/50
		2.5% °C	1% °C	Dry °C	Wet °C											
Schefferville	550	-37	-39	24	16	8550	13	64	410	0.8	800	180	4.5	0.3	0.33	0.42
Senneterre	310	-34	-36	29	21	6180	22	91	740	0.9	925	100	3.3	0.3	0.25	0.32
Sept-Îles	5	-29	-31	24	18	6200	15	106	760	1.0	1125	300	4.1	0.4	0.42	0.54
Shawinigan	60	-26	-29	29	23	5050	22	102	820	1.0	1050	180	3.1	0.4	0.27	0.35
Shawville	170	-27	-30	30	23	4880	23	96	670	0.8	880	160	2.8	0.4	0.27	0.35
Sherbrooke	185	-28	-30	29	23	4700	23	96	900	1.0	1100	160	2.2	0.6	0.25	0.32
Sorel	10	-25	-27	29	23	4550	20	102	800	0.9	975	180	2.8	0.4	0.34	0.43
Sutton	185	-25	-27	29	23	4600	23	96	990	1.1	1260	160	2.4	0.4	0.29	0.37
Tadoussac	65	-26	-28	27	21	5450	18	96	700	0.9	1000	180	3.7	0.4	0.41	0.52
Témiscaming	240	-30	-32	30	22	5020	23	96	730	0.9	940	100	2.5	0.4	0.25	0.32
Terrebonne	20	-25	-27	29	23	4500	23	96	830	0.9	1025	160	2.6	0.4	0.31	0.40
Theftord Mines	330	-26	-28	28	22	5120	22	107	950	1.1	1230	160	3.5	0.6	0.27	0.35
Thurso	50	-26	-28	30	23	4820	23	91	800	0.9	950	160	2.4	0.4	0.31	0.40
Trois-Rivières	25	-25	-28	29	23	4900	20	107	860	1.0	1050	180	2.8	0.4	0.34	0.43
Val-d'Or	310	-33	-36	29	21	6180	20	86	640	0.8	925	100	3.4	0.3	0.25	0.32
Varennes	15	-24	-26	30	23	4500	23	96	810	0.9	1000	160	2.6	0.4	0.31	0.40
Verchères	15	-24	-26	30	23	4450	23	96	810	0.9	1000	160	2.7	0.4	0.34	0.43
Victoriaville	125	-26	-28	29	23	4900	21	102	850	1.0	1100	180	2.6	0.6	0.27	0.35
Ville-Marie	200	-31	-34	30	22	5550	23	96	630	0.8	825	120	2.3	0.4	0.31	0.40
Wakefield	120	-27	-30	30	23	4820	23	91	780	0.9	1020	160	2.4	0.4	0.27	0.34
Waterloo	205	-25	-27	29	23	4650	23	96	980	1.1	1250	160	2.5	0.4	0.27	0.35
Windsor	150	-25	-27	29	23	4700	23	96	930	1.0	1075	160	2.3	0.4	0.25	0.32
<b>New Brunswick</b>																
Alma	5	-21	-23	26	20	4500	18	144	1175	1.3	1450	260	2.6	0.6	0.37	0.48
Bathurst	10	-23	-26	30	22	5020	20	106	775	0.9	1020	180	4.1	0.6	0.37	0.48
Boiestown	65	-25	-28	29	21	4900	20	96	800	0.9	1075	180	3.6	0.6	0.30	0.39
Campbellton	30	-26	-28	29	22	5500	20	107	725	0.9	1025	180	4.3	0.4	0.35	0.45

Table C-2 (Continued)

Table C-2 (Continued)

Province and Location	Elev., m	Design Temperature				Degree-Days Below 18°C	15 Min. Rain, mm	One Day Rain, 1/50, mm	Ann. Rain, mm	Moist. Index	Ann. Tot. Ppn., mm	Driving Wind Pressures, Pa, 1/5	Snow Load, kPa, 1/50		Hourly Wind Pressures, kPa	
		January		July 2.5%									S <sub>s</sub>	S <sub>r</sub>	1/10	1/50
		2.5% °C	1% °C	Dry °C	Wet °C											
Edmundston	160	-27	-29	28	22	5320	23	91	750	0.9	1000	160	3.4	0.6	0.30	0.38
Fredericton	15	-24	-27	29	22	4670	22	112	900	1.0	1100	160	3.1	0.6	0.30	0.38
Gagetown	20	-24	-26	29	22	4460	20	112	900	1.0	1125	180	2.8	0.6	0.31	0.40
Grand Falls	115	-27	-30	28	22	5300	23	107	850	1.0	1100	160	3.6	0.6	0.30	0.38
Miramichi	5	-24	-26	30	22	4950	20	96	825	1.0	1050	200	3.4	0.6	0.32	0.41
Moncton	20	-23	-25	28	21	4680	20	112	850	1.0	1175	220	3.0	0.6	0.39	0.50
Oromocto	20	-24	-26	29	22	4650	22	112	900	1.0	1110	160	3.0	0.6	0.30	0.39
Sackville	15	-22	-24	27	21	4590	18	112	975	1.1	1175	220	2.5	0.6	0.38	0.49
Saint Andrews	35	-22	-24	25	20	4680	19	123	1000	1.2	1200	220	2.8	0.6	0.35	0.45
Saint John	5	-22	-24	25	20	4570	18	139	1100	1.3	1425	260	2.3	0.6	0.41	0.53
Shippagan	5	-22	-24	28	21	4930	18	96	800	1.0	1050	260	3.4	0.6	0.49	0.63
St. George	35	-21	-23	25	20	4680	18	123	1000	1.2	1200	220	2.8	0.6	0.35	0.45
St. Stephen	20	-24	-26	28	22	4700	20	123	1000	1.2	1160	180	2.9	0.6	0.33	0.42
Woodstock	60	-26	-29	30	22	4910	22	107	875	1.0	1100	160	3.1	0.6	0.29	0.37
<b>Nova Scotia</b>																
Amherst	25	-21	-24	27	21	4500	18	118	950	1.1	1150	220	2.4	0.6	0.37	0.48
Antigonish	10	-17	-20	27	21	4510	15	123	1100	1.3	1250	240	2.3	0.6	0.42	0.54
Bridgewater	10	-15	-17	27	20	4140	16	144	1300	1.5	1475	260	1.9	0.6	0.43	0.55
Canso	5	-13	-15	25	20	4400	15	123	1325	1.5	1400	260	1.7	0.6	0.48	0.61
Debert	45	-21	-24	27	21	4500	18	118	1000	1.2	1200	240	2.1	0.6	0.37	0.48
Digby	35	-15	-17	25	20	4020	15	130	1100	1.3	1275	260	2.2	0.6	0.43	0.55
Greenwood (CFB)	28	-18	-20	29	22	4140	16	118	925	1.1	1100	280	2.7	0.6	0.42	0.54
<b>Halifax Region</b>																
Dartmouth	10	-16	-18	26	20	4100	18	144	1250	1.4	1400	280	1.6	0.6	0.45	0.58
Halifax	55	-16	-18	26	20	4000	17	150	1350	1.5	1500	280	1.9	0.6	0.45	0.58
Kentville	25	-18	-20	28	21	4130	17	118	950	1.1	1200	260	2.6	0.6	0.42	0.54
Liverpool	20	-16	-18	27	20	3990	16	150	1325	1.5	1425	280	1.7	0.6	0.48	0.61

Table C-2 (Continued)

Table C-2 (Continued)

Province and Location	Elev., m	Design Temperature				Degree-Days Below 18°C	15 Min. Rain, mm	One Day Rain, 1/50, mm	Ann. Rain, mm	Moist. Index	Ann. Tot. Ppr., mm	Driving Rain Wind Pressures, Pa, 1/5	Snow Load, kPa, 1/50		Hourly Wind Pressures, kPa	
		January		July 2.5%									S <sub>s</sub>	S <sub>t</sub>	1/10	1/50
		2.5°C	1%°C	Dry °C	Wet °C											
Lockeport	5	-14	-16	25	20	4000	18	139	1250	1.4	1450	280	1.4	0.6	0.47	0.60
Louisbourg	5	-15	-17	26	20	4530	15	118	1300	1.5	1500	300	2.1	0.7	0.51	0.65
Lunenburg	25	-15	-17	26	20	4140	16	144	1300	1.5	1450	260	1.9	0.6	0.48	0.61
New Glasgow	30	-19	-21	27	21	4320	15	135	975	1.1	1200	260	2.2	0.6	0.43	0.55
North Sydney	20	-16	-19	27	21	4500	15	123	1200	1.4	1475	300	2.4	0.6	0.46	0.59
Pictou	25	-19	-21	27	21	4310	15	107	950	1.1	1175	260	2.2	0.6	0.43	0.55
Port Hawkesbury	40	-17	-19	27	21	4500	15	128	1325	1.5	1450	260	2.1	0.6	0.48	0.61
Springhill	185	-20	-23	27	21	4540	18	118	1075	1.2	1175	220	3.1	0.6	0.37	0.48
Stewiacke	25	-20	-22	27	21	4400	18	128	1050	1.2	1250	240	1.8	0.6	0.39	0.50
Sydney	5	-16	-19	27	21	4530	15	123	1200	1.4	1475	300	2.3	0.6	0.46	0.59
Tatamagouche	25	-20	-23	27	21	4380	18	118	875	1.1	1150	260	2.2	0.6	0.43	0.55
Truro	25	-20	-22	27	21	4500	18	118	1000	1.2	1175	240	2.0	0.6	0.37	0.48
Wolfville	35	-19	-21	28	21	4140	17	118	975	1.1	1175	260	2.6	0.6	0.42	0.54
Yarmouth	10	-14	-16	22	19	3990	19	135	1125	1.3	1260	280	1.8	0.6	0.44	0.56
<b>Prince Edward Island</b>																
Charlottetown	5	-20	-22	26	21	4460	16	107	900	1.1	1150	350	2.7	0.6	0.44	0.56
Souris	5	-19	-21	27	21	4550	15	112	950	1.1	1130	350	2.7	0.6	0.45	0.58
Summerside	10	-20	-22	27	21	4600	16	112	825	1.0	1060	350	3.1	0.6	0.47	0.60
Tignish	10	-20	-22	27	21	4770	16	96	800	1.0	1100	350	3.2	0.6	0.51	0.66
<b>Newfoundland and Labrador</b>																
Argentia	15	-12	-14	21	18	4600	15	107	1250	1.5	1400	400	2.4	0.7	0.59	0.75
Bonavista	15	-14	-16	24	19	5000	18	96	825	1.1	1010	400	3.1	0.6	0.66	0.84
Buchans	255	-24	-27	27	20	5250	13	107	850	1.0	1125	200	4.7	0.6	0.47	0.60
Cape Harrison	5	-29	-31	26	16	6900	10	106	475	0.9	950	350	6.3	0.4	0.47	0.60
Cape Race	5	-11	-13	19	18	4900	18	130	1425	1.7	1550	400	2.3	0.7	0.82	1.05
Channel-Port aux Basques	5	-13	-15	19	18	5000	13	123	1175	1.4	1520	450	3.6	0.7	0.61	0.78

Table C-2 (Continued)

Table C-2 (Continued)

Province and Location	Elev., m	Design Temperature				Degree-Days Below 18°C	15 Min. Rain, mm	One Day Rain, 1/50, mm	Ann. Rain, mm	Moist. Index	Ann. Tot. Ppn., mm	Driving Wind Pressures, Pa, 1/5	Snow Load, kPa, 1/50		Hourly Wind Pressures, kPa	
		January 2.5% 2.5°C	January 1% 1°C	July 2.5% Dry °C	July 2.5% Wet °C								S <sub>s</sub>	S <sub>r</sub>	1/10	1/50
Comer Brook	35	-16	-18	26	20	4760	13	91	875	1.1	1190	300	3.7	0.6	0.43	0.55
Gander	125	-18	-20	27	20	5110	18	91	775	1.0	1180	280	3.7	0.6	0.47	0.60
Grand Bank	5	-14	-15	20	18	4550	15	123	1350	1.6	1525	400	2.4	0.7	0.58	0.74
Grand Falls	60	-26	-29	27	20	5020	15	86	775	1.0	1030	240	3.4	0.6	0.47	0.60
Happy Valley-Goose Bay	15	-31	-32	27	19	6670	18	80	575	0.8	960	160	5.3	0.4	0.33	0.42
Labrador City	550	-36	-38	24	17	7710	15	70	500	0.8	880	140	4.8	0.3	0.31	0.40
St. Anthony	10	-25	-27	22	18	6440	13	86	800	1.1	1280	450	6.1	0.6	0.68	0.87
Stephenville	25	-16	-18	24	19	4850	14	102	1000	1.2	1275	350	4.1	0.6	0.45	0.58
St. John's	65	-15	-16	24	20	4800	18	118	1200	1.4	1575	400	2.9	0.7	0.61	0.78
Twin Falls	425	-35	-37	24	17	7790	15	70	500	0.9	950	120	4.8	0.4	0.31	0.40
Wabana	75	-15	-17	24	20	4750	18	112	1125	1.3	1500	400	3.0	0.7	0.59	0.75
Wabush	550	-36	-38	24	17	7710	15	70	500	0.8	880	140	4.8	0.3	0.31	0.40
<b>Yukon</b>																
Aishihik	920	-44	-46	23	15	7500	8	43	190	0.6	275	40	1.9	0.1	0.27	0.38
Dawson	330	-50	-51	26	16	8120	10	49	200	0.6	350	40	2.9	0.1	0.22	0.31
Destruction Bay	815	-43	-45	23	14	7800	8	49	190	0.6	300	80	1.9	0.1	0.42	0.60
Faro	670	-46	-47	25	16	7300	10	33	215	0.6	315	40	2.3	0.1	0.26	0.35
Haines Junction	600	-45	-47	24	14	7100	8	51	145	0.6	315	180	2.2	0.1	0.24	0.34
Snag	595	-51	-53	23	16	8300	8	59	290	0.6	350	40	2.2	0.1	0.22	0.31
Teslin	690	-42	-44	24	15	6770	10	38	200	0.5	340	40	3.0	0.1	0.26	0.34
Watson Lake	685	-46	-48	26	16	7470	10	54	250	0.6	410	60	3.2	0.1	0.26	0.35
Whitehorse	655	-41	-43	25	15	6580	8	43	170	0.5	275	40	2.0	0.1	0.29	0.38
<b>Northwest Territories</b>																
Aklavik	5	-42	-44	26	17	9600	6	49	115	0.7	250	60	2.8	0.1	0.31	0.40
Behchokq / Rae-Edzo	160	-42	-44	25	17	8300	10	60	175	0.6	275	80	2.3	0.1	0.31	0.40
Echo Bay / Port Radium	195	-42	-44	22	16	9300	8	60	160	0.7	250	80	3.0	0.1	0.41	0.53

Table C-2 (Continued)

Table C-2 (Continued)

Province and Location	Elev., m	Design Temperature				Degree-Days Below 18°C	15 Min. Rain, mm	One Day Rain, 1/50, mm	Ann. Rain, mm	Moist. Index	Ann. Tot. Ppn., mm	Driving Wind Pressures, Pa, 1/5	Snow Load, kPa, 1/50		Hourly Wind Pressures, kPa	
		January		July 2.5%									S <sub>s</sub>	S <sub>r</sub>	1/10	1/50
		2.5% °C	1% °C	Dry °C	Wet °C											
Fort Good Hope	100	-43	-45	28	18	8700	9	60	140	0.6	280	80	2.9	0.1	0.34	0.44
Fort McPherson	25	-44	-46	26	17	9150	6	50	145	0.7	315	60	3.2	0.1	0.31	0.40
Fort Providence	150	-40	-43	28	18	7620	10	71	210	0.6	350	100	2.4	0.1	0.27	0.35
Fort Resolution	160	-40	-42	26	18	7750	10	60	175	0.6	300	140	2.3	0.1	0.30	0.39
Fort Simpson	120	-42	-44	28	19	7660	12	76	225	0.6	360	80	2.3	0.1	0.30	0.39
Fort Smith	205	-41	-43	28	19	7300	10	65	250	0.6	350	80	2.3	0.2	0.30	0.39
Hay River	45	-38	-41	27	18	7550	10	60	200	0.6	325	140	2.4	0.1	0.27	0.35
Inuvik	45	-43	-45	26	17	9600	6	49	115	0.7	425	60	3.1	0.1	0.31	0.40
Mould Bay	5	-44	-46	11	8	12900	3	33	25	0.9	100	140	1.5	0.1	0.45	0.58
Norman Wells	65	-43	-45	28	18	8510	9	60	165	0.6	320	80	3.0	0.1	0.34	0.44
Tungsten	1340	-49	-51	26	16	7700	10	44	315	0.8	640	40	4.3	0.1	0.34	0.44
Ulukhaktok / Holman	10	-39	-41	18	12	10700	3	44	80	0.9	250	120	2.1	0.1	0.67	0.86
Wrigley	80	-42	-44	28	18	8050	10	54	220	0.6	350	80	2.8	0.1	0.30	0.39
Yellowknife	160	-41	-44	25	17	8170	10	60	175	0.6	275	100	2.2	0.1	0.31	0.40
<b>Nunavut</b>																
Alert	5	-43	-44	13	8	13030	3	22	20	1.0	150	100	2.6	0.1	0.59	0.75
Arctic Bay	15	-42	-44	14	10	11900	3	38	60	0.9	150	160	2.4	0.1	0.43	0.55
Arviat	5	-40	-41	22	16	9850	8	65	225	0.9	300	240	3.0	0.2	0.45	0.58
Baker Lake	5	-42	-44	23	15	10700	5	55	160	0.8	260	180	3.4	0.2	0.42	0.54
Eureka	5	-47	-48	12	8	13500	3	27	25	1.0	70	100	1.6	0.1	0.43	0.55
Igluigaariuk / Chesterfield Inlet	10	-40	-41	20	14	10500	5	60	175	0.9	270	240	3.6	0.2	0.44	0.56
Iqaluit	45	-40	-41	17	12	9980	5	58	200	0.9	433	200	2.9	0.2	0.51	0.65
Iqaluktuuttiaq / Cambridge Bay	15	-41	-44	18	13	11670	4	38	70	0.9	140	100	1.9	0.1	0.39	0.50
Isachsen	10	-46	-48	12	9	13600	3	27	25	1.0	75	140	1.9	0.1	0.47	0.6
Kangiqiniq / Rankin Inlet	10	-41	-42	21	15	10500	5	65	180	0.9	250	240	3.0	0.2	0.47	0.6
Kanniqtuqaapik / Clyde River	5	-40	-42	14	10	11300	5	44	55	0.9	225	220	4.2	0.2	0.43	0.55

Table C-2 (Continued)

Province and Location	Elev., m	Design Temperature				Degree-Days Below 18°C	15 Min. Rain, mm	One Day Rain, 1/50, mm	Ann. Rain, mm	Moist. Index	Ann. Tot. Ppn., mm	Driving Rain Wind Pressures, Pa, 1/5	Snow Load, kPa, 1/50		Hourly Wind Pressures, kPa	
		January	July	2.5% °C	1% °C								Dry °C	Wet °C	S <sub>s</sub>	S <sub>r</sub>
Kugluktuk / Coppermine	10	-41	-43	23	16	10300	6	65	140	0.8	150	80	3.4	0.1	0.36	0.46
Nottingham Island	30	-37	-39	16	13	10000	5	54	175	0.9	325	200	4.7	0.2	0.61	0.78
Resolute	25	-42	-43	11	9	12360	3	27	50	0.9	140	180	2.0	0.1	0.46	0.59
Resolution Island	5	-32	-34	12	10	9000	5	71	240	0.9	550	200	5.5	0.2	0.96	1.23
Salliq / Coral Harbour	15	-41	-42	20	14	10720	5	65	150	0.9	280	200	3.8	0.2	0.45	0.58

Table C-2 (Continued)

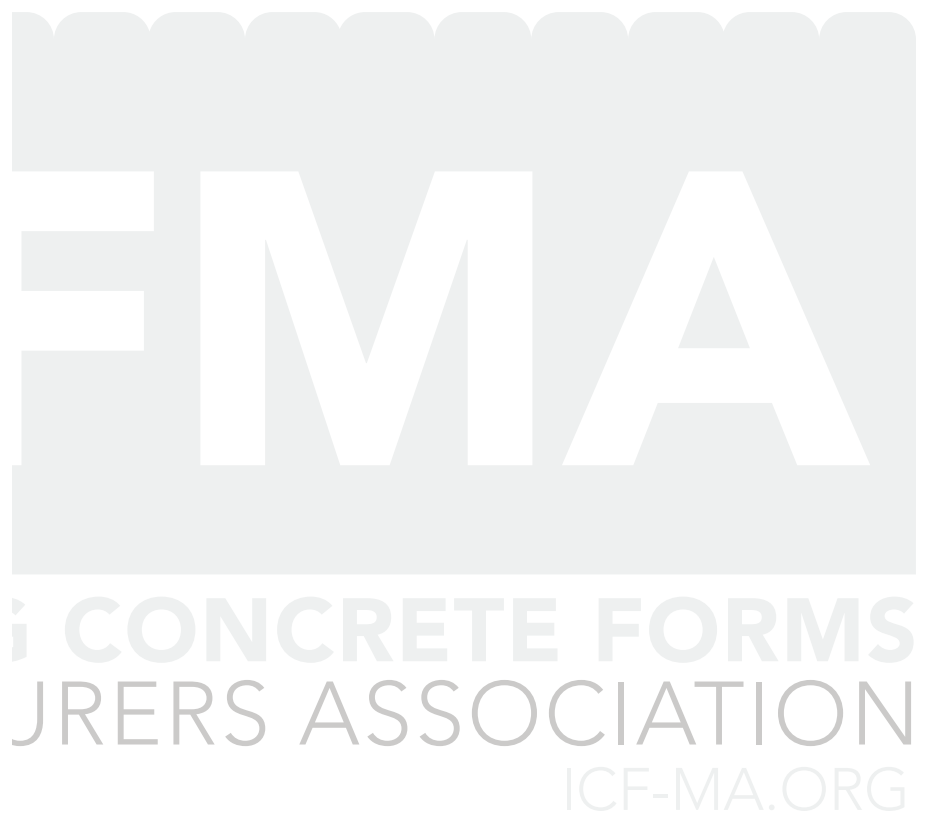









# The Insulating Concrete Forms Manufacturers Association Prescriptive ICF Design for Part 9 Structures in Canada

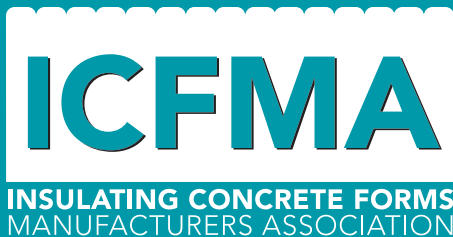

## THE INSULATING CONCRETE FORMS MANUFACTURERS ASSOCIATION

The Insulating Concrete Forms Manufacturers Association (ICFMA) is the North American non-profit trade association for the Insulated Concrete Form industry and was founded in 2014 by a dedicated group of manufacturers with the interest of improving the quality and acceptance of Insulated Concrete Form construction.

## MISSION

The mission of the ICFMA is to promote and enhance the social, environmental and economic value of insulating concrete forms in the North American marketplace.

**LEARN MORE ABOUT ICFS AT [ICF-MA.ORG](https://www.icf-ma.org)**